

May 2019

Epon Communication Network Topology Planning Based on Node Importance of Active Distribution Network

Yingqiao He

University of Wisconsin-Milwaukee

Follow this and additional works at: <https://dc.uwm.edu/etd>



Part of the [Electrical and Electronics Commons](#)

Recommended Citation

He, Yingqiao, "Epon Communication Network Topology Planning Based on Node Importance of Active Distribution Network" (2019). *Theses and Dissertations*. 2075.

<https://dc.uwm.edu/etd/2075>

This Thesis is brought to you for free and open access by UWM Digital Commons. It has been accepted for inclusion in Theses and Dissertations by an authorized administrator of UWM Digital Commons. For more information, please contact open-access@uwm.edu.

EPON COMMUNICATION NETWORK TOPOLOGY PLANNING BASED ON NODE
IMPORTANCE OF ACTIVE DISTRIBUTION NETWORK

by

Yingqiao He

A Thesis Submitted in
Partial Fulfillment of the
Requirements for the Degree of

Master of Science

in Engineering

at

The University of Wisconsin-Milwaukee

May 2019

ABSTRACT

EPON COMMUNICATION NETWORK TOPOLOGY PLANNING BASED ON NODE IMPORTANCE OF ACTIVE DISTRIBUTION NETWORK

by

Yingqiao He

The University of Wisconsin-Milwaukee, 2019
Under the Supervision of Dr. Lingfeng Wang

A large amount of DGs (distributed generations) and distributed resources accessing to distribution network is a characteristic of present distribution network. So the concept of the active distribution network is proposed, which is a new form of distribution network with flexible power network structure and active control and management with high permeability of DGs in the distribution network. According to the actual operation state of power system, active distribution network actively manages the massive distributed power supply and adaptively adjusts the network to satisfy the requirements of economy and security power supply.

This thesis aims to propose a feasible optimization scheme for the communication network based on the evaluation results of all nodes' importance in the distribution network. This solution not only meets the current technical requirements, but also considers the possible expansion of communication network in the future. Different from the most used dual link connection for all communication network nodes, this section of this thesis selects a certain portion of the important nodes in the power grid for optimization, and the remaining nodes connected to the communication network adopt a single link. The optimization result can provide a more scientific and reasonable solution for planner to build a communication network. The link entropy index is used to evaluate the edges' significance on maintaining the global connectivity for the whole power and communication network.

© Copyright by Yingqiao He, 2019
All Rights Reserved

TABLE OF CONTENTS

Chapter 1 Introduction	1
1.1 Research Background	1
1.1.1 Active Distribution Network	1
1.1.2 CPS in distribution network :	3
1.1.3 Reliability on distribution network :	5
1.1.4 The structure of the distribution automation system	6
1.2 Research Objective and Thesis Layout	7
Chapter 2 Distribution network	8
2.1 Introduction of distribution network	8
2.1.1 Distribution network in power system :	8
2.1.2 Distribution automation system structure	9
2.2 Reliability of distribution network	12
2.2.1 Researches on reliability evaluation methods of distribution network	12
2.2.2 The impact of distributed power and energy storage devices on reliability	13
2.3 The importance of distribution grid node	15
2.3.1 Influence of distribution network topology on reliability	15
2.3.2 Researches on identifying important node and links	15
2.4 Importance of distribution network nodes :	16
2.4.1 The topology of distribution network	16
2.5 The importance of distribution network node evaluation model	17
2.5.1 Importance indicator of node	17
2.6 Case study	20
2.6.1 IEEE 33 nodes system	20
2.6.2 Results and analysis	21
Chapter 3 Communication network	22
3.1 Introduction of distribution communication network	22
3.1.1 Status of distribution communication network	22
3.1.2 The structure of distribution communication network	22
3.1.3 Construction scheme of access layer communication network	23
3.2 Access layer communication network design scheme	24
3.2.1 Researches on PON	24
3.2.2 Comparison of different PON technologies	25
3.2.3 EPON	26
3.3 Network topology of access layer in distribution communication network	28
3.3.1 The technical principle of EPON network topology	32
3.3.2 Original communication network	34
3.4 Model of communication network	35
3.4.1 Objective function	35
3.4.2 Constraints	36
3.4.3 GA algorithm	39

3.6 Case study	40
3.6.1 Results of topology	41
3.6.2 Investment of optimization	49
3.6.3 The results of reliability	49
3.6.4 Analysis of results	51
Chapter4. Link Entropy	52
4.1 Introduction of LE	52
4.1.1 Definition and description of entropy	52
4.1.2 Definition and description of link entropy	53
4.2 The index of Link Entropy	53
4.2.1 Strategy 1—Nonnegative Matrix Factorization	54
4.2.2 Strategy 2—QS(Quantification Strategy)	55
4.2.3 Case study	56
4.3 Conclusion	58
Chapter5. Conclusion and Future Work	59
5.1 Conclusion	59
5.2 Future Work	60
References	61

LIST OF FIGURES

Figure 1-1 The structure of distribution communication network.....	6
Figure 2-1 Single power supply radial wiring.....	19
Figure 2-2 The process of calculating electricity exchange	19
Figure 2-3 The topology of distribution network.....	20
Figure 2-4 The significance of nodes in power grid.....	21
Figure 3-1 The structure of distribution communication network.....	23
Figure 3-2 The structure of EPON.....	27
Figure 3-3 Tree-type network of single power supply redundancy protection.....	29
Figure 3-4 Hand-in-hand network of whole chain protection.....	30
Figure 3-5 Dual-power dual-T network of full link protection.....	30
Figure 3-6 Ring-type protection network.....	31
Figure 3-7 Original communication network.....	34
Figure 3-8 The progress of genetic algorithm.....	40
Figure 3-9 The communication planning scheme in ratio=0.2.....	41
Figure 3-10 The abstract diagram of new cable lines in rate=0.2.....	42
Figure 3-11 The communication planning scheme in ratio=0.3.....	42
Figure 3-12 The abstract diagram of new cable lines in ratio=0.3.....	43
Figure 3-13 The communication planning scheme in ratio=0.4.....	43
Figure 3-14 The abstract diagram of new cable lines in ratio=0.4.....	44
Figure 3-15 The communication planning scheme in ratio=0.5.....	44
Figure 3-16 The abstract diagram of new cable lines in ratio=0.5.....	45
Figure 3-17 the abstract diagram of new cable lines in ratio=0.5.....	45

Figure 3-18 The communication planning scheme in ratio=0.6.....	46
Figure 3-19 The abstract diagram of new cable lines in ratio=0.6.....	46
Figure 3-20 The abstract diagram of new cable lines in ratio=0.6.....	47
Figure 3-21 The communication planning scheme in ratio=0.7.....	47
Figure 3-22 The abstract diagram of new cable lines in ratio=0.7.....	48
Figure 3-23 The abstract diagram of new cable lines in ratio=0.7.....	48
Figure 3-24 The change of reliability after optimization.....	49
Figure 3-25 Sensitivity analysis of reliability and cost.....	51

LIST OF TABLES

Table 1. Comparison of cyber and Comparison.....4

Table 2 Cost of different ratio.....49

Table 3 Network component failure rates and availability.....50

Table 4 the value of LE_{ij} when ratio of important node =0.4.....58

ACKNOWLEDGEMENTS

First of all, I want to express my gratitude to my thesis advisor Dr. Lingfeng Wang. I am so grateful to study and work with him this year. I have learned a lot of electrical power knowledge from him, and I'm also impressed by his high academic standard for solving cutting-edge challenges. In this year, Dr. Wang gave me much guidance and help. I started to learn how to do research rigorously and how to be meticulous. Thanks to Dr. Wang for his tolerance and patience when I firstly started doing research. Also, he is a considerate and humorous person. When we came to UWM, he helped us adapt to the new environment quickly.

I want to appreciate Dr. Li Ma and Dr. Zhaoxi Liu for their help. Especially Dr. Ma, she is a kind and warm-hearted person who gave me much help and advice when I faced problem in my research. Throughout the writing of this thesis, she actively helped me to check the information and provide suggestions and opinions that are conducive to the writing of the thesis. With her help, the thesis was continuously improved.

I also want to appreciate my thesis committee: Dr. Chiu Tai Law and Dr. Guangwu Xu as they spent time to take part in my defense and gave me comments on my thesis. They are also experts in their respective academic fields and their academic achievements set good models for my future study.

I am also grateful to the financial support for this research. This work was supported in part by the National Science Foundation under Award ECCS1711617, in part by the Research Growth Initiative Program of University of Wisconsin-Milwaukee under Award 101X360, and in part by

the National Science Foundation Industry/University Cooperative Research Center on Grid-connected Advanced Power Electronic Systems (GRAPES) under Award GR-18-06.

Last but not least, I want to thank my parents and my friends far from my homeland for their full support and love.

Chapter 1 Introduction

1.1 Research Background

The emergence of new elements in power grids such as distributed resources, energy storage devices, and flexible loads poses new challenges to the operation and planning of distribution networks. The concept of active distribution network (ADN) emerges as the times require. The active distribution network is based on the actual operating state of the power system, with the aim of economy and safety, actively managing a large number of connected distributed resources, and adaptively adjusting the network, power source, and load distribution network. Large amounts of distributed renewable sources being grid-connected are changing the operational characteristics of distribution systems and power quality. In order to solve those problems, the concept of ADN was proposed [2].

1.1.1 Active Distribution Network

ADN is a new type of distribution network technology with flexible power network structure and active control and management with high permeability of distributed power connected to the distribution network. According to the actual operation state of power system, active distribution network actively manages the massive distributed power supply and adaptively adjusts the network to satisfy the requirements of economy and security of power supply. The construction goal of the active distribution network is to improve the consumption ability of distribution network for increasing distributed energy, reduce the peak valley difference in the operation process and the total network loss of distribution networks, satisfy users' demand for high quality power supply,

promote users to take the active participation in electrical power system optimal operation, further mining the utilization potential of equipment in power system, effectively enhance the level of comprehensive utilization of energy [2-3].

A large amount of DGs and DRs accessing to distribution network is a characteristic of present ADN. More and more distributed generation and the installation of "demand-side" power resources, the introduction of a variety of distributed generations into the network, the increase of electric vehicles, smart home appliances and other new facilities and different ways of electricity consumption from traditional method are increasingly improved [4]. The electrical distribution system will transfer from the previous simple power distribution network to current power exchange system, which takes the responsibility of power production, storage, transmission and distribution. These changes bring profound influences on the pattern of power supply, and address new challenges to the planning, operation and control of power system, especially to the distribution network [15-20].

The communication network planning for ADN is a complex and important system engineering that requires planners to think systematically. In order to obtain the largest economic benefit, the distribution network planning must ensure the safety and reliability of the distribution network and ensure the economic operation of the distribution network. Therefore, the main task of the distribution network planning is to provide the corresponding optimal communication network structure. So that it could ensure the reliability of the distribution network on the premise of satisfying the requirements for a secured and stable power system, based on the background of load growth and power planning scheme during planning period [5-8].

The planning of the traditional communication network for distribution networks is mainly based on the qualitative analysis of previous practical work experience, investment waste, and high operating costs. From the perspective of Cyber Physical System^[9], after the large-scale access of distributed energy and intelligent user terminals, the power grid side of the distribution network has suffered from tremendous changes.

The emerging of distributed power sources and users who had the function of demand respond that has the ability to control itself according to users' demands side have obvious influence in the distribution network. At the same time, these new features of the distribution network make it necessary to consider the influence of the power grid side in the planning work of the distribution communication network and need to meet the increasing capacity demand and the reliability requirement in the level of both power grid and the communication network. Planners also need to avoid the problem of excessive investment in the process of construction.

1.1.2 CPS in distribution network:

In recent years, distribution network has gradually been more complex and computerized. To control numerous components and devices in distribution system^[20-21], the communication system should have the ability of transmitting increasing data and control signals. ADN adopts a variety of control methods to avoid status deterioration, further enhance network performance, and improve efficiency of network. However, the active management cannot be achieved without Information and Communications Technology (ICT). On the one hand, timely and accurate transmission and decision-making are the basis for enabling a variety of active control functions; on the other hand, ICT system's random failures may lead to adverse consequences such as operational condition deterioration and widespread blackouts. Thus, the control characteristics of

ADN make it highly dependent on ICT, which is essentially similar to the Cyber Physical System (CPS)^[10]. So that ADN can be regarded as a typical Cyber Physical Distribution System (CPDS).

Computing and communication capabilities will soon be embedded in all types of objects and structures in the physical environment. Applications with enormous societal impact and economic benefit will be created by harnessing these capabilities across both space and time. Such systems that bridge the cyber-world of computing and communications with the physical world are referred to as cyber-physical systems. CPS are physical and engineered systems whose operations are monitored, coordinated, controlled and integrated by a computing and communication core^[10-18].

Structurally, CPS can be divided into two major parts: cyber subsystem and physical subsystem, which interact with and interdepend on each other^[2]. In CPS, Cyber subsystem represents the information world composed of computing systems and network systems, including discrete computing processes, logical communication processes and feedback control processes; Physical subsystem represents processes, objects or components in the physical world, which refers to various natural or man-made systems, operating in continuous time according to the objective laws of the physical world^[19]. The differences between Cyber and Physical are summarized in Table 1.

Table 1. Comparison of cyber and Physical

Objects of Comparison	Computation Basis	Computation Model	Logic Basis	Execution Law	Theory Basis	Data Format	...
Cyber	Discrete binary description	Synchronous process	Process sequence	Computation abstract	Computer science	Structured	...
Physical	Continuous differential equation description	Asynchronous event	Time	Objective laws in physical world	Domain engineering	Unstructured	...

As modern power grid becomes more developed and advanced, the interdependency between cyber and power networks becomes stronger. Cyber-power systems provide broad control over complex and large power systems through a heterogeneous network architecture of sensors, actuators, and processors. As a result, conventional reliability assessments, power system operation analysis, and power system planning evaluation techniques are not sufficient enough to provide a reasonable planning for the whole system. Thus, an interdependent study is required that takes both the power and the communications networks into account. Although the cyber and power layers of a system may be evaluated separately because they have become more interdependent, a combined simulation of the power system and the communications network is in high demand [3].

According to the comparison of cyber level and physical level and the characteristics of CPS, the distribution network and corresponding communication network are considered here as a typical CPS system. From the information level, if the communication devices or related communication devices of a node is destroyed, the command from upper layer cannot reach the demand side and the nodes could not feedback its own information to the control layer.

1.1.3 Reliability on distribution network

CPS in distribution network is a complex integrated system of computing systems, communication networks, and power distribution networks. The assessment of the power network alone could not meet the practical needs. In short, whether it is in a power network or a communication network, the damage of its function will affect other. The topology of the network plays a significant role in the interdependency between two networks, especially the node in the network [23-26].

There are three major reliability evaluation methods for CPS: 1) analytical method is used in both subsystems; 2) analytical method is used in cyber subsystem and simulation method is used in physical subsystem; 3) simulation method is used in both subsystems. The analytical method is usually used in simple scenarios. While the physical subsystem usually adopts the simulation method, simulation and analytical methods can both be used in the cyber subsystem according to system complexity [2].

1.1.4 The structure of the distribution automation system

According to the hierarchical structure characteristics and information flow of the distribution automation system, the distribution communication network should adopt the hierarchical structure on the backbone layer and the access layer according to the scale of the distribution network. The hierarchical structure of the distribution communication network is shown in Figure 1-1. FTU is feeder terminal device in figure 1-1.

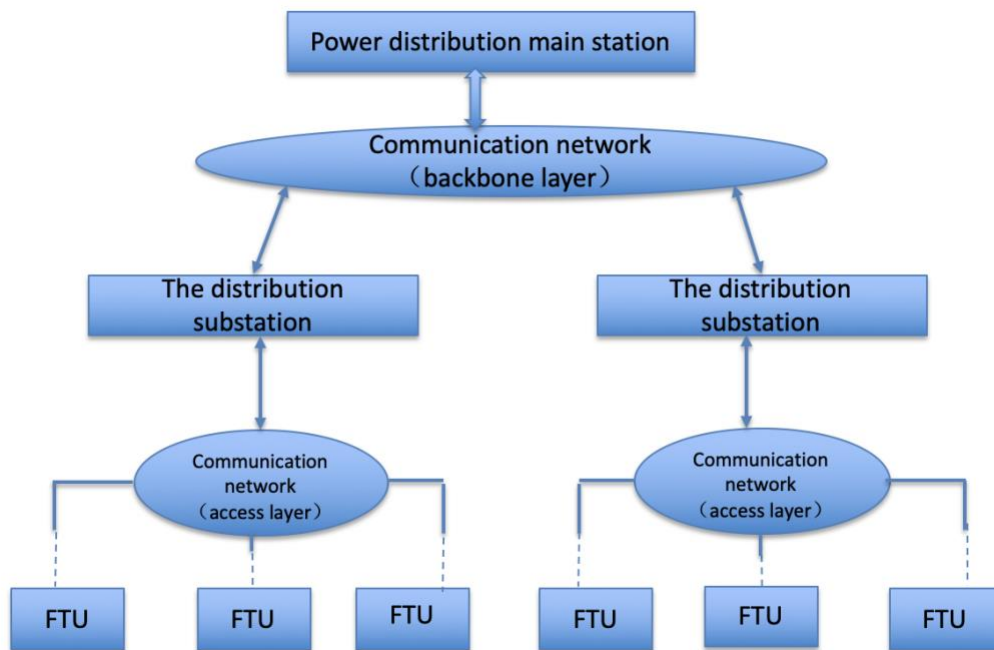

Figure 1-1. the structure of distribution communication network

The meaning of each communication layer in Figure 1-1 is as follows:

1) Backbone communication network:

The communication channel between the main distribution station and the distribution substation is the backbone communication network.

2) Access layer communication network:

The communication channel from the distribution substation to the power distribution terminal is the access layer communication network. The power distribution terminal is mostly installed with the power distribution equipment such as the on-column switch, the ring network cabinet, the switch station, the power distribution room, and the distribution transformer. This thesis is focus on the access layer of communication network.

1.2 Research Objective and Thesis Layout

The terminal optimization model for the system construction comprehensive cost, the communication network topology and the system reliability are established in this thesis. According to above analysis, system reliability and economic costs are mutually constrained and affected in the planning process. Therefore, this thesis will focus on economics and reliability, the planning goal is to minimize the economic cost, considering the redundancy of future system capacity expansion and load growth.

The thesis is organized into five chapters. Firstly, the planning work mainly includes modeling the distribution network and identifying the key node identification. Chapter 2 provides the model for calculating the importance of each node in distribution network which is the physical layer of CPS considering the load demand and renewable energy generation. In this thesis, a new

index considering the network structure and operational characteristics is proposed to analyze each node in the power grid, and the importance of all nodes in the distribution network is ranked by this indicator. The more electricity this node transmitted in the distribution network, the more important the communication signals related to this node. Physically, if the equipment installed at this node is damaged, the grid structure topology will be damaged, and the reliability of the grid will deteriorate. Chapter 3 presents the optimization model for communication network which is the cyber layer of CPS based on the results from Chapter 2, also making a comparison between the reliability of the original network and the optimized network. Based on the EPON (Ethernet Passive Optical Network) communication technology^[21-22], this optimal method is proposed here for distribution network considering the importance of nodes in power systems, which can quantify the impact of power system on the reliability and security of communication network. The sensitivities analysis of reliability and investment is also performed in chapter 3. Chapter 4 utilizes a LE index to quantify the important edge in communication network, which analyze the optimized network from another perspective. The conclusions and future work are presented in chapter 5.

Chapter 2 Distribution network

2.1 Introduction of distribution network

2.1.1 Distribution network in power system :

According to the roles in the power system, the power grid can be divided into the transmission grid and the distribution grid. The transmission network is a power network that transmits the power generated by the power plants through the high-voltage transmission lines, and completing the long-distance transmission of the electric energy, which is also called the main

network in the power system. The distribution network receives power from the transmission network and distributes it to the users through various distribution facilities. According to the voltage level, the distribution network can be divided into high-voltage distribution network (35kV /110kV), medium-voltage distribution network (6kV /10kV/20kV) and low-voltage distribution network (220V /400V) ^[10-11]. This thesis will focus on 10kV distribution network. The distribution network is usually composed of 220kV urban substations, 110kV substations, transformer stations, distribution rooms, overhead lines, cable lines, sectional switches, annular net cabinet, distribution transformer and other primary equipment, and secondary equipment such as relay protection, automatic devices, measuring and metering devices, communication and control equipment.

Distribution network locates at the end of power system. Due to its direct connection with users, the quality and ability of power supply is guaranteed by it. Compared with other power system parts, it has the following characteristics: A) there are many types and quantities of power distribution equipment, which are inconvenient to manage; B) uneven urban development and complex topologies in distribution network; C) directly facing customers, network operation is greatly affected by customers; D) high turnover rate of primary equipment result in frequent power grid faults.

2.1.2 Distribution automation system structure

The distribution automation system is an automation system that realizes the monitoring and control of distribution network operation. It is the important part of distribution automation. It has the functions of power distribution data acquisition and monitoring, feeder automation, grid analysis application and interconnection with related application systems.

For the convenience of management and maintenance, distribution automation system usually adopts hierarchical structure. Distribution automation system mainly consists of four parts: distribution main station, distribution electronic station, distribution terminal and communication channel [28-30].

1) Main power distribution station:

The main power distribution station is the core part of the distribution automation system and consists of hardware equipment such as servers, workstations, network equipment and supporting software. The main power distribution station is responsible for receiving the distribution terminal information from the distribution station, or the real-time information directly from the distribution terminal.

The main power distribution station analyzes and processes this information to master the operation status of the distribution network, and adjusts the real-time operation of the distribution network to complete the monitoring and management of the entire distribution network. The main power distribution station can also interconnect with other systems through the information exchange bus to complete integration and information sharing. The power distribution main station is generally set in the distribution network control center.

2) The distribution substation

Distribution substation is the middle layer between the main station and the terminal. It can communicate with the distribution terminal downward and the upper main distribution station in various communication ways. According to the function, the distribution substation can be divided

into communication substation and monitoring substation. The communication substation is only responsible for data collection and forwarding of distribution terminals within its jurisdiction; the monitoring sub-station also has the functions of fault isolation and power restoration, not only the functions of gathering communication data. Electronic distribution stations are usually installed in urban 220kV substations, 110kV substations or large open and closed stations that meet the requirements of communication and operation conditions.

3) Distribution terminal:

The power distribution terminal is an automatic device installed at the operation site of the primary equipment, which executes the operation command from upper main distribution station and uploads the information of the primary equipment. Distribution terminals are classified into feeder terminal unit (FTU), distribution terminal unit (DTU), transformer terminal unit (TTU), and other types of power distribution terminals, depending on the application object.

4) Communication channel

The communication channel is a communication network that connects the main distribution station and the distribution substation, and transmits automation information between them. The communication channel is composed of communication device, a communication medium (wired communication & wireless communication), and other devices (auxiliary common to optical fiber communication splitters), and is distributed between devices that need communication at each layer of the distribution automation system. As the main means to improve power supply reliability and power quality, the composition of the distribution automation system is described in details in this thesis.

In particular, the communication channel acts as the nervous system of the distribution automation system, and is responsible for the uploading and dispatching of various monitoring information and control commands. It is an important basic part for realizing distribution automation, which leads to the discussion of the key issues in this thesis—the communication network topology in the distribution automation system will be elaborated in the next chapter.

2.2 Reliability of distribution network

2.2.1 Researches on reliability evaluation methods of distribution network

Analytical method and simulation method are the main methods to evaluate the reliability of distribution network. The analytical method mainly uses failure mode consequence analysis method (FMEA), minimum path method, network equivalent method and fault travel method. FMEA by means of comprehensive analysis of power consumption, total number of power failures, power failure events and other data, in order to attain the possibility of power failure for the purpose, focusing on the user and equipment.

However, the FMEA method has high computational complexity due to its large scale, wide coverage and extremely complex structure. Considering above reasons that the fault traversal method, network equivalent method, minimum path method and other methods are proposed, and the FMEA method is optimized and improved. The minimum path method is to find the least-path from each load point of the distribution network to the power point, convert the nodes beyond the least-path and superimpose them on the minimum path. Therefore, only considering the influence of the minimum road node on the load point can complete the reliability evaluation of the distribution network, reduce the computational complexity, calculate the power supply reliability of the load point, and then realize the reliability evaluation of the distribution network.

2.2.2 The impact of distributed power and energy storage devices on reliability

In the traditional reliability assessment of power distribution systems, the equivalent of the upper power grid is usually adopted, just considering the availability of a single power source (substation, bus). Comparing with the upper power supply, the capacity of a single distribution feeder is very small, so when the upper power supply still works, it means that its capacity is sufficient.

The distributed power supply is different from the traditional power supply, the output power of the distributed generation is generally small. Since the variety, the randomness, the intermittence and the uncontrollability of the output power of the distributed power supply, so that complexity of the problem has increased to a certain extent just considering the influence of load change factors. At the same time, we must consider the influence of the volatility produced by a large number of distributed power supply, which makes the reliability analysis even more complex and difficult.

After the access of distributed power, it becomes an important part of the distribution system, so it needs to be analyzed as well. For the distribution system, the number of components in the distribution network itself is already very large, which will lead to the further increase of the system state scale after a large number of distributed power sources are connected. The number of components in the distribution network is large, especially after the emergence of a large number of distributed power source, which will lead to a further increase in the scale of analyzing the system.

The energy storage device is an indispensable part of supporting the independent and stable operation of the distributed power generation system. Due to the fluctuation of the output of the distributed power supply, the distributed power generation system needs to be equipped with energy storage device to smooth its output, charge the energy storage device when the output of the distributed power supply is excessive, and release the electric energy when the output of the distributed power supply is insufficient.

The most significant impact of distributed generation is that it will lead to profound influence in the way distribution systems operating. There are two operation models of distributed power supply: island operation and grid-connected operation. When the distributed power supply is running in the grid-connected model, it also affects the reliability evaluation process of the power distribution system. In the grid-connected model, the loads could receive electricity from the grid and the distributed generation at the same time, which seems to be more reliable.

However, considering the economic factor, the redundant capacity of the upper power supply should be appropriately reduced when a large number of distributed power supplies are connected, which may lead to the failure of the distributed generation. When the power supply fails to supply all the loads due to insufficient capacity, the system reliability will be damaged to some extent. Reasonable selection of reliability index is the premise of system reliability evaluation. However, the reliability indexes widely used in the current reliability evaluation of distribution system are all based on the traditional distribution system, with the power failure frequency, time and power supply shortage of a single load point as the basic elements. After the access of distributed power supply, due to the fundamental characteristics of the distribution system has changed, whether the applicable indicators fully reflect the impact of system reliability is still an issue.

2.3 The importance of distribution grid node

2.3.1 Influence of distribution network topology on reliability

There are many parts in the operation of distribution network, and the devices and components of each part is affected by various internal and external factors. Therefore, the grid structure design, equipment aging degree, humidity, temperature, system operating state address many challenges. Among the various influencing parameters mentioned above, the most important and critical ones in the whole system operation are equipment states and power grid structure. So that this thesis evaluates the reliability of distribution network from the perspectives of its topology and operation status of those devices.

Obviously, in a heterogeneous network, if the importance of the node can be identified, the node with a high degree of importance will be attacked first, and this will cause the connectivity performance and reliability of network to drop sharply, and even cause the entire network to fail. Therefore, it is extremely important and necessary to optimize the network for the CPS of the distribution network at the planning level to identify the nodes or regions with high importance [27].

2.3.2 Researches on identifying important node and links

At present, the research on key line identification is rich, while the research on node importance evaluation is relatively rare. In many complex networks, the research on key node identification of specific power communication networks is still in its infancy, but great progress has been made in the identification of key nodes in complex networks. At present, the importance of network nodes is analyzed mainly from the perspectives of system science and social network.

The main idea of systematic scientific analysis method is that the importance of the node is equivalent to the destructiveness of the network after this node or edges are deleted. For example, the node contraction method [16] analyzes the network condensation before and after the contraction of the relevant nodes in the network. The degree of change evaluates the importance of nodes. In [17], based on the node contraction method, the strength of interaction between nodes is considered. The weighted network is used to describe the details of the interaction between nodes to determine the importance of the node. The node deletion method [16] determines the importance of the node by deleting a node in the network and using changes in indicators such as network connectivity. The core idea of social network analysis method is that the importance is equivalent to the significance of nodes. The indicators as degree, mediation and feature vector of the node are used in the evaluation process to distinguish the importance of the nodes. These evaluation indicators distinguish the individuals from another individuals. For example, the importance of a node in the network is to calculate the importance of the node by using the number of nodes of the shortest path between two nodes in one network, but the algorithm is more complex and not suitable for identifying complex networks such as power communication networks.

2.4 Importance of distribution network nodes :

2.4.1 The topology of distribution network

The connection mode of distribution network refers to the topological structure of distribution line in the power supply area, which can be divided into single power supply radial network topology, double power supply hand-in-hand ring network topology, multi-section and multi-connection network topology, multi-supply and one-backup network topology. The selection of the network topology of the distribution network directly determines the power supply capacity

and transmit capacity of the line. Therefore, it should be reasonably planned and constructed in the construction of the distribution network.

2.5 The importance of distribution network node evaluation model

The distribution network is a complex structure consisting of lines, equipment and multiple load points. In order to extract key information of distribution network, it needs to be abstracted and simplified, which means that a simple topology composed of nodes and lines is used to describe a complex distribution network. The distribution network could be modelled as a graph $G = (V, E)$, where V is a set of n nodes and E is a set of m edges.

Each node of the distribution network may be connected to distributed power supplies, energy storage devices, and users of different types and importance levels. This thesis not only considers these factors to the new indicators, but also considers the contribution of this node to the entire distribution network.

2.5.1 Importance indicator of node

$$I_{node}(i) = \alpha * F_{input}(i) + \beta * F_{output}(i) + \delta * \Delta E \quad (2.1)$$

α, β, δ is the correction factor. Generally, $\alpha + \beta + \delta = 1$

$$1) F_{input}(i) = \frac{G_i}{G_{max}} \quad (2.2)$$

Here,

G_i is the amount of distributed generation connected to node i ;

G_{max} is the largest distributed generation among power grid.

$$2) F_{output}(i) = \frac{L_i}{L_{max}} \quad (2.3)$$

Here,

$F_{output}(i)$ represents the total amount of load, which connected to node i ;

$F_{output}(i)$ could reflects the load of node i ;

L_i is the load of node i ;

L_{max} is the largest load among power grid.

$$3) \Delta E(i) = \frac{E(Y) - E(Y-1)}{E(Y)} \quad (2.4)$$

$E(Y)$ is original global efficiency,

$$E(Y) = \frac{1}{\frac{n*(n-1)}{2}} * \sum_{i \in \{G\}, j \in \{D\}} \frac{1}{e^{\frac{(d_{ij} - \bar{d})}{d}} * V_{ij, max}} \quad (2.5)$$

$E(Y - 1)$ is the global efficiency when one node is removed,

$\Delta E(i)$ is the efficiency change after removing node i .

Here,

node i belongs to generator set $\{G\}$ and node j belongs to load set $\{D\}$, and other nodes belong to set $\{C\}$.

n is the number of nodes in power grid,

\bar{d} is the average shortest distance,

d_{ij} is the electrical distance between node i and node j , this thesis calculates the electrical distance by using the resistance between two nodes.

V_{ij} is the amount of electricity exchange between the power generation node i and the node j .

The principle of how to calculate V_{ij} as below:

When we calculate the exchange amount of a pair of nodes, we start the calculation from the end load node of one line, the calculation direction is back-forward. In addition, we assume that the electricity of a load node need is transferred from its nearest generation node and the electricity produced by one generation node is consumed by its nearest load node. Firstly, we find the node

x_n farthest from node 1. If x_n is a generation node, we set $x_n = i$. Then we need to find the nearest load node i to node j . If the generation amount of node i is greater than the load amount of node j , the generation node i will distribute its electricity to the second nearest load node; if the generation amount of node i is less than the load amount of node j , the load node j will consume electricity from another nearest generation node. We could use this principle to find the amount of electricity change between corresponding generation nodes and load nodes. This process of calculating V_{ij} is described in below flow chart.

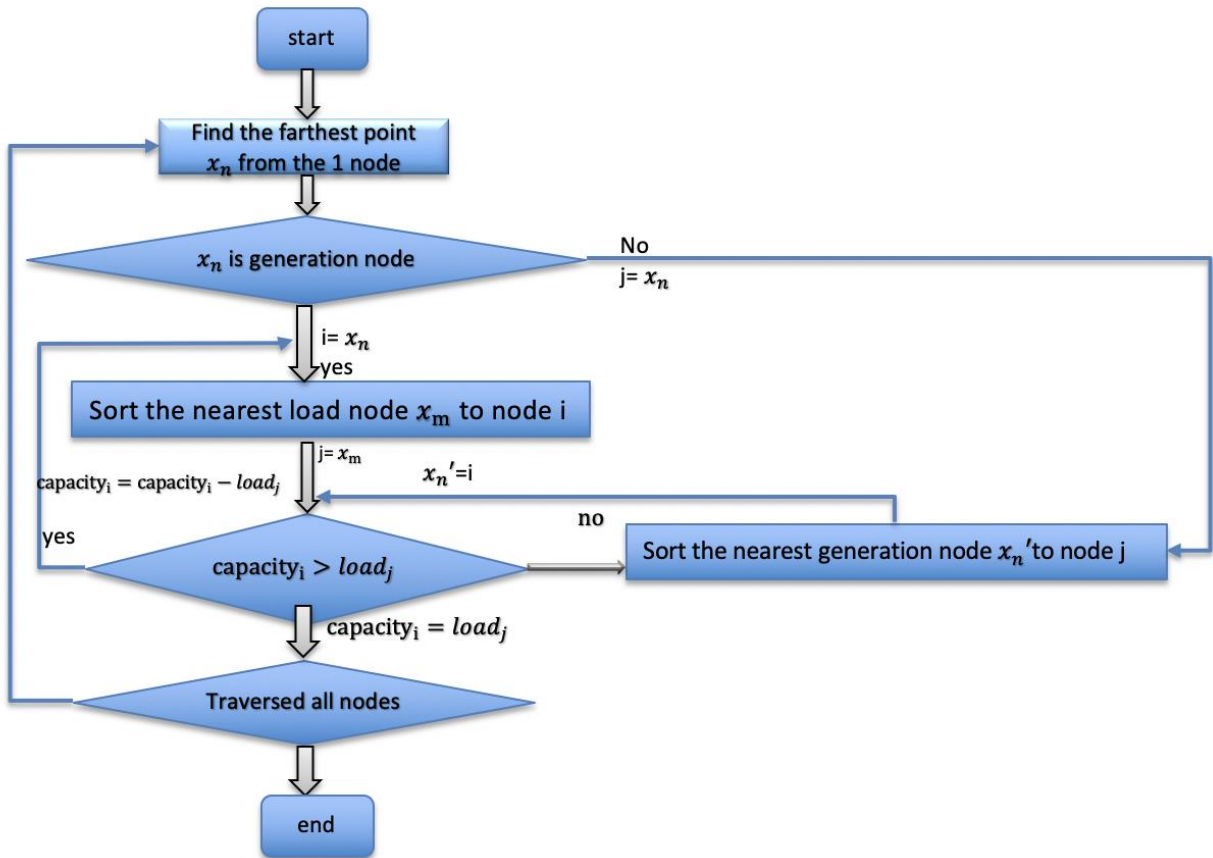

Figure 2-1 the process of calculating electricity exchange

By comparing with the average shortest distance, the change of the indicator can reflect the following characteristics:

If $d_{ij} < \bar{d}$, when the power transmission distance is short and the more power is delivered between node i and node j, these two nodes take more responsibility of keep global efficiency.

If $d_{ij} > \bar{d}$, when the power transmission distance is long and the less power is delivered between node i and node j, these two nodes take less responsibility of keep global efficiency.

2.6 Case study

According to the new indicators we proposed, which consider distributed power, load and global efficiency, combined with the concept of complex network theory. We find the important node in distribution network with various distributed generations.

This section selects the IEEE33 node system as the experimental object. The system network structure diagram is shown in Figure 2.3. The detailed parameters of the system are shown in Table 2.1. In order to verify the impact of the DG analyzed in Section 2.2 on the distribution network, this section uses the P and Q constant DG to access the distribution network as an example for analysis and verification.

2.6.1 IEEE 33 nodes system

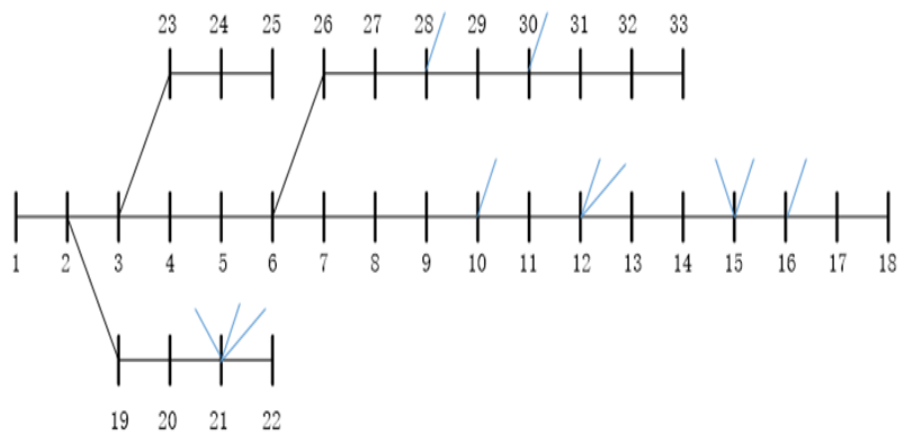

Figure 2-2 the topology of distribution network

As figure 2-3 shows, this IEEE 33 nodes system has some distributed generation nodes on it. In addition, a time-span data is used in the evaluation process, which is the average of typical scenes. These nodes with blue lines represent the node is connect to the distributed power supply in the distribution network.

2.6.2 Results and analysis

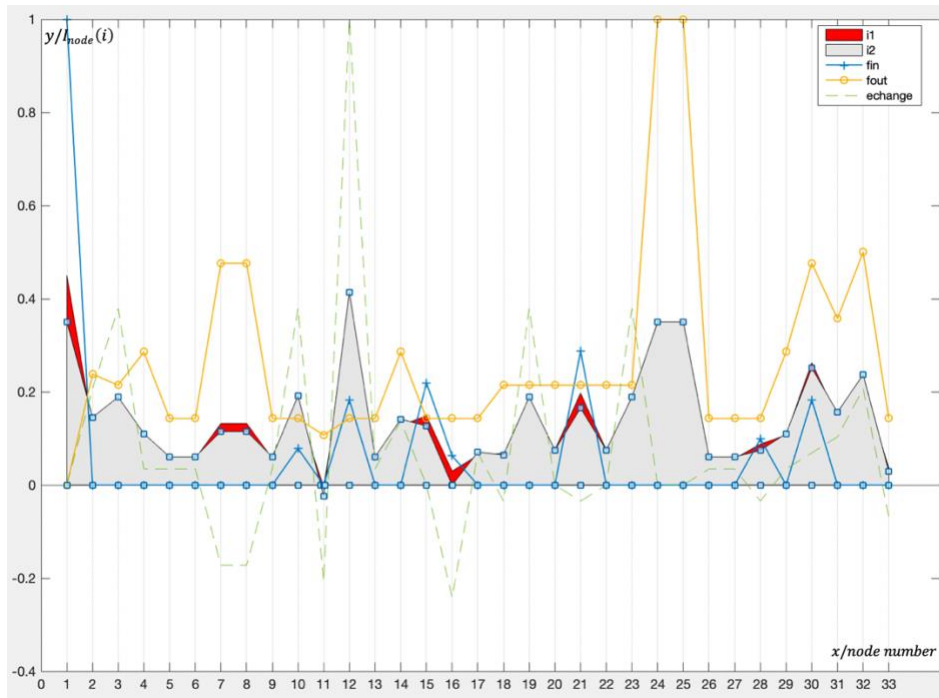

Figure 2-3 The significance of nodes in power grid

The red area and grey area are both the importance of all nodes, which are different from the weight of each part when calculating the indicator $I_{node}(i)$. In figure 2-4, these blue lines, yellow lines and green lines are the values of every part of $I_{node}(i)$. The most important node is node 1, because node 1 is connected to the large grid, most of the electricity power of the distribution network is provided from node 1. The second and third important nodes are 24, 25, respectively, whose load on these two nodes is very large. Nodes 12, 30 are ranked in the top rank of importance since distributed generation devices are connected to these nodes.

Chapter 3 Communication network

3.1 Introduction of distribution communication network

3.1.1 Status of distribution communication network

The power communication network now covers six major parts: power generation, transmission (line), distribution network, power consumption, dispatching, and power transformation. The main structure of the power communication network consists of the main communication network and the terminal access network. The main communication network mainly covers four parts of power generation, transmission, dispatch, and power transformation.

As an extension of the power communication network, the terminal access network mainly means the distribution of electricity. The distribution communication network becomes the fusion part of the backbone layer network and the terminal access layer, and the terminal access layer covers the relevant communication nodes such as the distribution terminal in the distribution communication network. Due to the wide variety of distribution network points, complex and variable topological structure and poor operating conditions, it has become the key and difficult problem in the construction of distribution network communication system.

3.1.2 The structure of distribution communication network

In this thesis, the original network topology of the communication network adopts a single link. The following focuses on the typical distribution network connection model --- single power supply radial network topology. The single-supply radial wiring method is shown in Figure 2.1. The wiring structure is simple and clear, and the main line is equipped with 3~4-stage sectional switches to improve the flexibility of operation. Since the main line is powered by only one power

supply, the reliability of users is poor. The single-supply radial wiring method has less investment, and is mostly used for power supply lines in urban suburbs. In figure3-1, OLT is optical line terminal; POS is passive optical splitter; ONU is optical network unit.

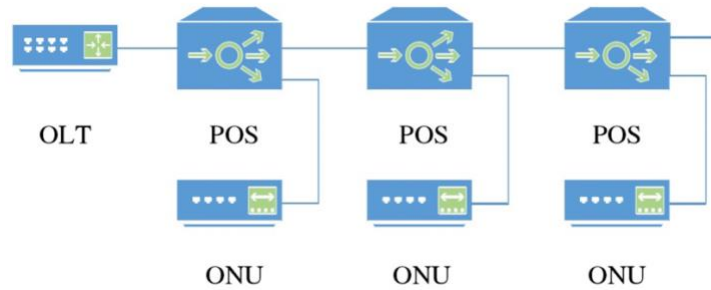

Figure 3-1 Single power supply radial wiring

3.1.3 Construction scheme of access layer communication network

Due to the large number of distribution terminals, wide distribution range, and poor operating environment, the planning of access layer communication network is a difficult technical issue in the construction of distribution communication networks [12].

The communication mode of the access layer communication network should be adapted to local conditions, and a variety of communication media such as optical fiber, wireless microwave, and distribution line carrier can be reasonably matched to meet the needs of different automation services, and at the same time, a large number of dispersed communication terminals can be accessed. The fiber-optic private network communication method should select high-speed Ethernet technology such as Ethernet passive optical network and industrial Ethernet. This thesis mainly gathers at the access layer of the communication network.

Comparing with the access layer, the backbone layer of the distribution communication network has a limited number of communication nodes and a fixed location, and it is more convenient to plan and construct. The access layer covers a large number of distributed distribution terminals, so that the communication network planning is extremely complicated. Therefore, the access layer communication network is the focus and difficulty of the distribution communication network.

3.2 Access layer communication network design scheme

Since the distribution automation system has too many and complicated functions, it is unrealistic and uneconomical to use a single communication method to satisfy all the functional requirements. Therefore, in the distribution communication network, according to local conditions, the needs of different automation functions and a variety of communication methods are selected in combination, and the optimal scheme is selected according to above economic and technical indicators.

3.2.1 Researches on PON

Passive optical network is an optical communication network composed of many passive optical components using pure optical transmission medium, and has excellent transmission characteristics of optical fiber communication. At the same time, the use of passive optical components, the reliability of optical network communication is more guaranteed than before, and the anti-electromagnetic interference capability is also further improved. Now Optical Network is most used in Passive Optical networks (Passive Optical Network, PON), the Network transmission way has obvious advantage than the traditional Network transmission way, both from the

transmission speed and transmission distance, and so on, has the incomparable virtues than the traditional way, now many operators have invested large sums of money at home and abroad to study, gradually become the mainstream of broadband access technology.

In the past twenty years, the traffic of global network was increasing by 150%-160% every year [7]. According to the historic growth of network traffic, in the following years the network traffic will keep increasing. As predicted, the bandwidth requirement of a residential subscriber exceeded 250 Mbps in 2015 and may reach 1 Gbps in far future. Therefore, PON should offer higher total capacity and have an actual bandwidth upgrade for each subscriber.

Driven by ever-increasing users' demands for broad-band services to support high quality IPTV, e-learning, interactive games, and future multimedia services, it is expected that the data rate demand will continuously grow over the next decades. Optical access network is the most future-proof way to widely improve the network performance and effectively meet users' demands for broadband services. As the most flexible, scalable, and future-proof optical access technology, passive optical network (PON) has emerged as the most successful and widely deployed optical access solution in recent years.

3.2.2 Comparison of different PON technologies

Now many operators have abandoned the traditional active optical fiber transmission method and started to increase the investment in the construction of passive optical network. The optical fiber transmission method has been gradually recognized, and the traditional copper wire transmission method gradually faded out. In the development process of PON, the original APON/BPON (ATM Passive Optical Network/Broadband Passive Optical Network) gradually

evolved into EPON/GPON (Gigabit-Capable Passive Optical Network) [31]. EPON/GPON, as the most widely used access method in the world, has become a very mature technology. At the beginning of the development of PON technology, APON technology of ATM bearer protocol directly promoted the development of PON technology, and BPON was the further expansion of APON. GPON has a longer transmission distance, which makes the network coverage more extensive and the access method more flexible. EPON is a combination of PON technology and traditional Ethernet, which reduces the cost of network construction and operation, facilitates network construction and expansion, and provides more users with flexible access options.

3.2.3 EPON

An Ethernet passive optical network is actually a Passive Optical Network based on Ethernet. It adopts PON technology in physical layer, using Ethernet protocol in link layer and PON topology structure to realize Ethernet access.

This thesis uses Ethernet passive optical networks (EPON) , an emerging local subscriber access architecture that combines low-cost point-to-multipoint fiber infrastructure with Ethernet. EPONs are designed to carry Ethernet frames at standard Ethernet rates. An EPON uses a single trunk fiber that extends from a central office to a passive optical splitter, which then fans out to multiple optical drop fibers connected to subscriber nodes. Other than the end terminating equipment, no component in the network requires electrical power, hence the term passive. Local carriers have long been interested in passive optical networks for the benefits they offer: minimal fiber infrastructure and no powering requirement in the outside plant. With Ethernet now emerging

as the protocol of choice for carrying IP traffic in metro and access networks, EPON has emerged as a potential optimized architecture for fiber to the building and fiber to the home. [1]

1) the structure of EPON

EPON is a single-fiber and bidirectional Optical access Network from point to multiple points based on gigabit Ethernet. It consists of Optical Line Terminal (OLT) installed in Distribution station, Optical Network Unit (ONU) installed in Distribution Terminal and Optical Distribution Network (ODN) in Distribution Network. ODN can connect one OLT and multiple ONU, which consists of main optical cable, splitter and branch optical cable, thus providing bidirectional transmission of optical signals. The structure of EPON is shown in figure 3.2.

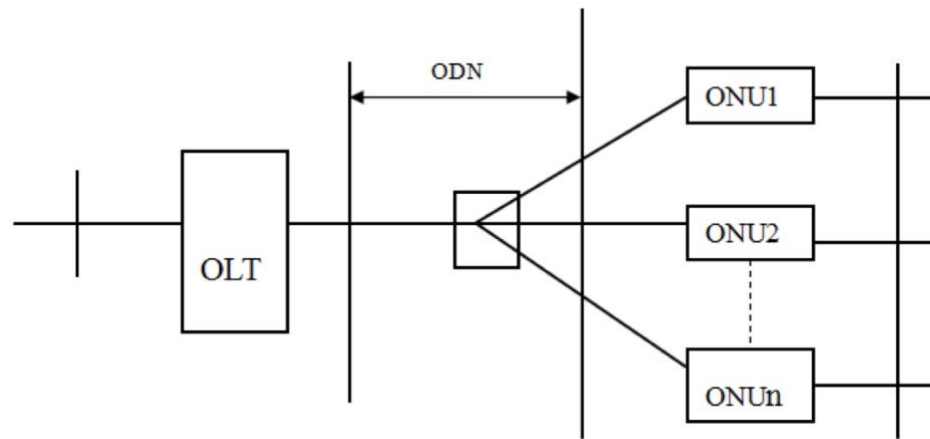

Figure 3-2 The structure of EPON

2) Advantages of EPON:

- a) Long transmission distance; the transmission distance is over 20 kilometers, far more than the traditional DSL distance.
- b) Good system stability: the PON system is mainly composed of passive devices, and the failure rate is significantly lower than that of active devices.

-
- c) High access rate: PON system can provide symmetric and asymmetric rates flexibly. The current bandwidth range is 155Mbps- 2488Mbps, which can be upgraded to 10Gb/s in the future.
- d) Various kinds of support services: the PON standard defines the third wavelength, which can be used to access digital TV and IPTV TV signals on OLT and support the three-in-one service.
- e) Save fiber resources: the PON system uses different wavelength λ (multiplexing technology) through uplink transmission and downlink transmission to realize bidirectional transmission of single fiber. This feature saves nearly 50% of the fiber resources and the optical transceiver module, compared to the traditional need for at least two optical fibers for one receiver and one transmitter.
- f) Cost reduction: a large amount of investment in passive devices and optical fiber can save the corresponding electricity costs, machine room rental costs, equipment transportation costs, engineering materials costs and so on.
- g) Quick and flexible: PON mainly adopts passive devices, which are convenient and fast to access and simple and flexible to expand capacity.

3.3 Network topology of access layer in distribution communication network

When the network protection of EPON is carried out on the access layer of distribution communication network, the communication network structure used in engineering practice includes: tree-type network of single power supply redundancy protection, hand in hand network of whole chain protection, dual-power dual-T network of full link protection, and ring-type protection network.

The single-supply redundancy protection tree network is a multi-level beam splitting tree structure connected by a 1: N non-average splitter (POS). The topology is shown in Figure 3-3. The OLT is placed at the electronic station, and two optical splitters are respectively connected to the two PON ports of the OLT to form redundancy protection. Each optical splitter is connected to the ONU in a tree-like manner, thereby implementing redundancy protection of the entire communication network.

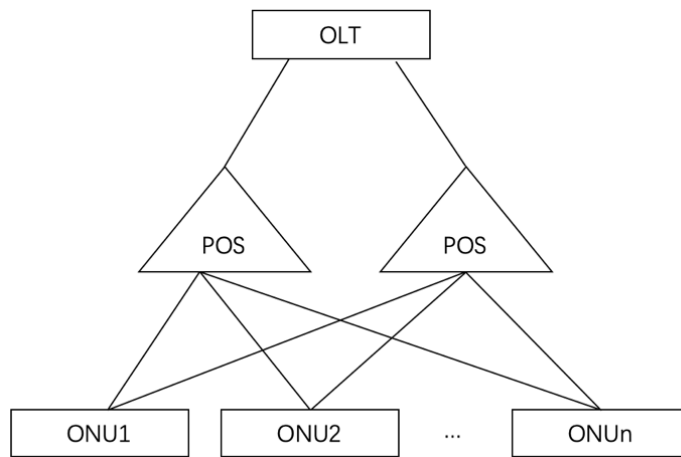

Figure 3-3 Tree-type network of single power supply redundancy protection

The Hand-in-hand network of whole chain protection network topology is shown in Figure 3-4. OLT is placed T at electronic station in this network structure, and two optical directions are extended by a 1:2 splitter in two optical directions. The link of each ONU implements "1+1" redundancy protection of the link through the dual PON port.

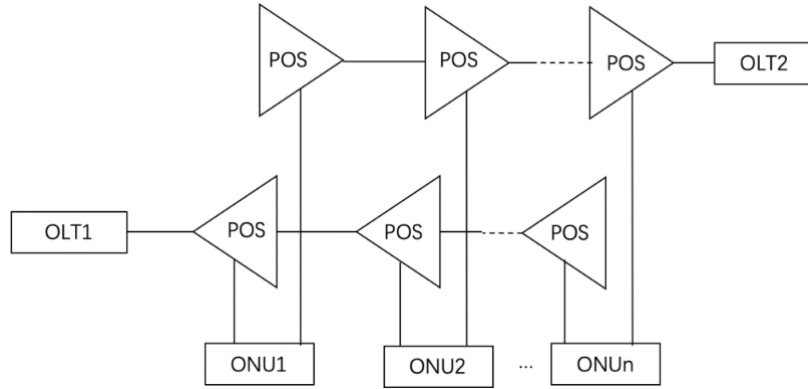

Figure 3-4 Hand-in-hand network of whole chain protection

The dual-power dual-T network of full link protection network topology is shown in Figure 3-5. Two OLTs (or two PON ports of one device) are placed at the same site, and the two T-shaped ports are connected to each other. The two ports of the ONU device are connected to the splitters that belong to two different OLTs. The difference between this topology and hand-in-hand network of whole chain protection network topology is that the optical directions of the OLT are basically the same and the position of devices and devices are almost the same.

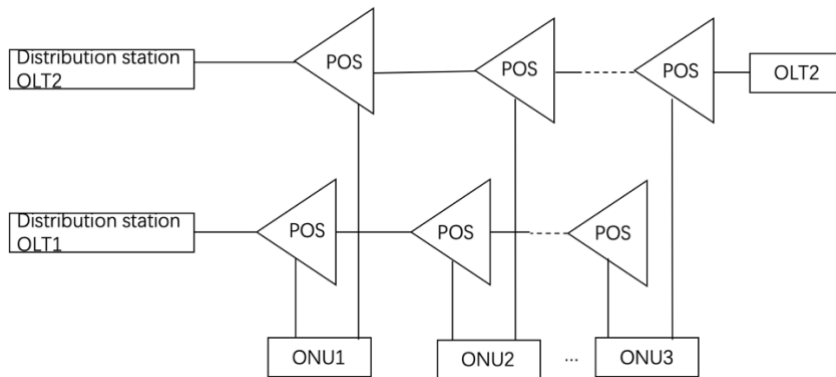

Figure 3-5 dual-power dual-T network of full link protection

The ring-type protection network topology is shown in Figure 3-6. The distribution substation OLT is connected to n ONU devices with dual optical interfaces, which are divided into two optical interfaces from two different optical directions to implement "1+1" link protection between the ONU devices and the OLT.

It is assumed that when the ONU device branch fiber breaks, the ONU devices and PON devices are damaged, or the ONU devices are powered off, all ONU devices could communicate signal with each other normally. However, the distribution area of the distribution network is large, and the fiber resources are comparatively small, which is not easy to form a ring network.

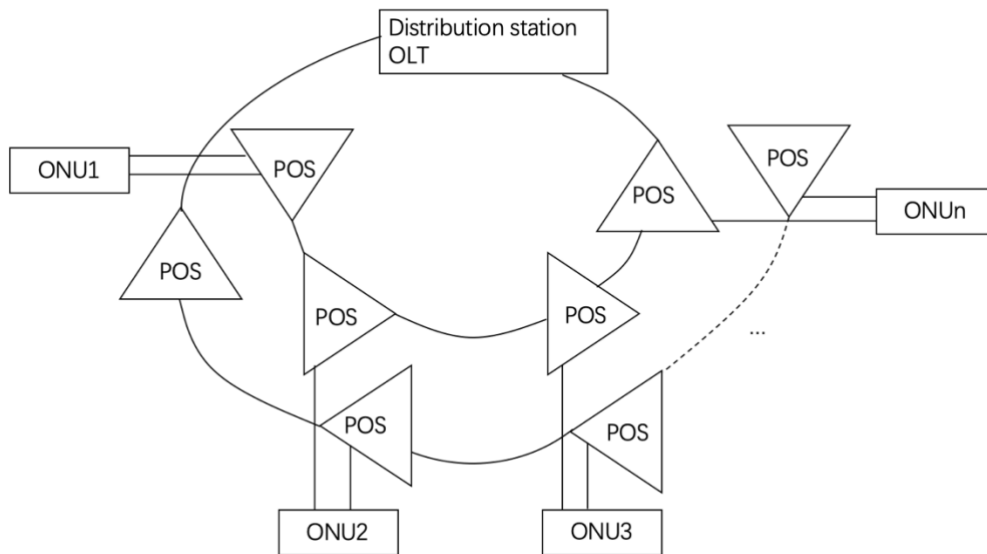

Figure 3-6 ring-type protection network

Topology is the most intuitive and essential attribute of communication network. The effective transmission of communication service is based on reliable physical network. In addition, terrorist attacks, malicious attacks and other attacks are difficult to obtain specific communication business operation mode, vulnerable network nodes are more likely to become the target of their attacks.

In conclusion, in order to ensure the reliability of power grid and communication network, the double-chain network structure is more reliable than the single - chain network structure topology. In the case that one of the OLTs devices is attacked or one of the OLTs device is damaged, the double-chain network structure could still enable ONUs to connect to OLT and realize information transmission.

3.3.1 The technical principle of EPON network topology

1) Cable selection and laying

At present, special electric power optical cables widely used in power communication networks include all-media self-supporting optical cable (ADSS), optical fiber composite overhead ground wire (OPGW), and optical fiber composite phase line (OPPC). According to the lightning protection requirements of the power industry, the main optical cable and the branch optical cable generally use non-metallic pipe optical cable and ADSS optical cable. When sufficient funds are available, the ADSS optical cable can be used instead of the non-metallic pipe optical cable to improve the mechanical tensile force that can be withstood when the optical cable is laid.

In the process of laying the optical cable, the existing power cable pipeline (buried, overhead, mixed) can be easily used, which can avoid the problem of increasing construction investment caused by the frequent entry and exit of the optical cable, reducing the municipal construction cost caused by frequent breakage, and reduce the construction of the project. cost. For the trunk cable, special attention should be paid to optimizing the route design. It is advisable to select the trunk road to facilitate the aggregation of important distribution node information.

1) Splitting model of ODN:

The optical splitter is an indispensable passive optical branching device in the EPON system. As a passive device connecting between the OLT and the ONU, the optical signal from the trunk optical cable is distributed by power to several branch optical cables. The splitter generally has a split ratio of 1:2/1:4/1:8/1:16. For splitters with a 1:2 split ratio, the power distribution will be uniform and non-uniform (5/95, 10/90, 30/70, etc.). In the practice, the splitter with different splitting ratios should be flexibly collocated according to actual needs. For 1:2 non-uniform splitters, it is generally applicable to tree-type, ring-shaped network structures, the power distribution ratio is selected according to the specific installation distribution.

3) ODN optical link protection design:

EPON has multiple optical link protection type, which combines the reliability requirements of distribution automation services and the characteristics of 10kV distribution lines. EPON mostly uses bidirectional link protection and ring link protection in practical applications. From the perspective of topology, the bidirectional link protection is extended by two main OLT cables started from different substations to form a hand-in-hand network. The ONU device with two ports at the power distribution terminal is connected to two different trunk cables. The original structure of the distribution communication network in this thesis adopts one of the hand-in-hand dual link protection. Usually, all the nodes in the communication network are connected to the second OLT, so that the reliability of the distribution communication network is the highest, but this setting wastes investment on some nodes that are not particularly important.

4) Optical channel attenuation design

The optical power attenuation of ODN is related to the factor of the splitter, the split ratio of the splitter, the number of active connections, the number of connectors of the cable, the length of the cable, and other factors. The maximum attenuation value of the ODN must be controlled during planning process to make it conform to the OLT and ONU. PON port optical power attenuation requirements.

The attenuation allowed by ODN optical channel attenuation is defined as the optical attenuation between the S/R and R/S reference points, including the sum of the attenuation introduced by the fiber, splitter, optical active connector, and fiber splice. To deal with the optical channel attenuation accounting of the farthest user terminal in the passive optical distribution network, the worst value method is used for the ODN optical channel attenuation accounting.

3.3.2 Original communication network

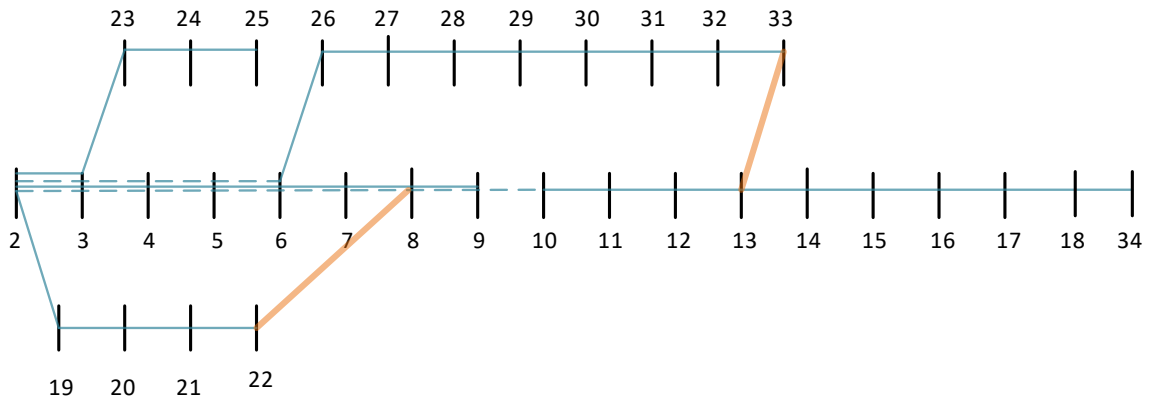

Figure 3-7 Original communication network

As shown in figure 3-7, the original communication network includes three ODNs. The blue lines in figure 3-7 are original communication lines, which means cable trench in those locations

has been constructed. The orange lines mean the new cable trench, which is designed to help for forming the double-link protection. Though the construction unit price of these two new cable trenches is higher than other cable trenches, adopting new cable trench will reduce the distance in some schemes.

3.4 Model of communication network

3.4.1 Objective function

$$\text{Min } C = F(N_{POS}, d, D) \quad (3.1)$$

The total cost C of an EPON communication network can be expressed as:

$$C = N_{OLT} * C_{OLT} + N_{ONU} * C_{ONU} + N_{POS} * C_{POS} + (D * C_1 + d * (C_2 + C_3)) \quad (3.2)$$

Here, N_{OLT}, N_{ONU} is certain. The variables are N_{POS}, d and D . N_{POS} is an integer variable.

C_{OLT} is the cost of one OLT; C_{ONU} is the cost of one ONU, C_{POS} is the cost of one POS;

N_{OLT} is the amount of OLT, N_{ONU} is the amount of ONU, N_{POS} is the amount of POS;

D is the total length of fiber from POS to ONU, d is the total length of fiber from OLT to POS.

C_1 is the cost and laying cost of the unit length fiber from POS to ONU, C_2 is the unit cost of the fiber from OLT to POS, C_3 is the cost of laying the unit trunk cable.

In the process of setting the optical cable, we could use the existing power cable pipeline, which can avoid the problem of increasing construction volume caused by the frequent entry and exit of the optical cable, reducing the construction cost caused by frequent breakage. Therefore, we should distinguish the fiber cost from laying cost.

About d and D :

There is x ONUs in the EPON network, and their positions are X_1, X_2, \dots, X_n respectively. There are y POSs, and their positions are Y_1, Y_2, \dots, Y_m respectively, where the position of the ONUs is known.

3.4.2 Constraints

1) reliability

The reliability of the communication network is that the communication path can be connected without interruption. The path of the communication network is a collection of nodes and links, and the availability of one path represents that all nodes and links on this path are available. If the two nodes have higher redundancy, it indicates that the connectivity of these two nodes is stronger and the reliability of their communication is higher. If an ONU has more than one path to the OLT, the ONU is more reliable from the perspective of topology. We should make some important ONUs have higher significance.

The reliability of path from i_{th} ONU to OLT:

$$R_i = r_{ONU} * (1 - \prod_{t=1}^T (1 - \prod_{s=1}^S r_{t,s})) \quad (3.3)$$

r_{ONU} is the reliability of i_{th} path, which is from ONU to OLT;

$r_{t,s}$ is the reliability of the s_{th} series link of the t_{th} parallel branch;

S represents the number of series components on one parallel branches, here we didn't distinguish links from device nodes, just considering all links and devices as components.

T represents the number of different parallel branches of an ONU arriving at the OLT.

$$a \ll R_i \quad (3.4)$$

a is a constant, the value of a will be obtained after certain evaluation of the communication network. Firstly, building an initial communication network for the communication network optimization problem, then a will be set refer to the reliability index of this communication network. This initial EPON communication network adopts the single main fiber network structure. The reliability of optimized network should be higher than this initial communication network. According to the evaluation result of original communication network, a is set as 0.9623.

1) optical power loss limitation of one path

The transmission index of one path is calculated according to the worst value method. The transmission loss between the OLT and the ONU should meet the following formulas.

$$L_{\text{total}} = \sum_{i=1}^n L_i + \sum_{i=1}^m K_i + \sum_{i=1}^p M_i + \sum_{i=1}^h F_i + L_{\text{redun}} \quad (3.5)$$

$$L_{\text{total}} \leq P_{\text{total}} \quad (3.6)$$

Here:

$\sum_{i=1}^n L_i$ is the sum of optical fiber attenuation of all optical channel,

$\sum_{i=1}^n L_i = \sum_{i=1}^n c * D_i$, c is a constant. When wavelength=1310 nm, c can be considered as 0.36 dB/km, when wavelength=1490 nm, c can be considered at 0.22 dB/km.

$$\sum_{i=1}^n D_i = d + D.$$

$\sum_{i=1}^m K_i$ is the sum of the insertion attenuation of m optical active connectors.

$\sum_{i=1}^p M_i$ is the sum of attenuation of p fiber fusion splices.

$\sum_{i=1}^h F_i$ is the sum of the insertion attenuations of the h optical splitters.

L_{redun} is the redundancy of optical power, generally $L_{\text{redun}} = 3\text{dB}$.

P_{total} is the total optical power budget of EPON. In most literature, $P_{\text{total}} = 26\text{dB}$.

Formula (3.5) is the limitation of one path from OLT to ONU

3) bandwidth capacity of network

The downstream rate of PON is fixed. When using EPON, a PON could provide 970 Mb/s data rate downstream. When calculating the downstream bandwidth capacity of a PON, the main consideration is to set the number of users according to the bandwidth requirement of the user.

$$\sum_{i=1}^{N_{ONU}} B_i \ll 970 \text{ Mb/s} \quad (3.7)$$

When measuring the bandwidth of the users connected to a single PON, we should ensure that the total traffic generated by all ONUs connected to the PON is less than the available bandwidth of the PON.

The calculation formulation of total flow for all users connected to the PON is as below:

$$\sum_{i=1}^{N_{ONU}} B_i = \sum_{i=1}^{N_{ONU}} \sum_{m=1}^{t_i} \varphi_{im} \quad (3.8)$$

Here,

B_i is service traffic of one single ONU, and φ_{im} is the service traffic of m_{th} service terminal in the i_{th} ONU.

Single ONU service traffic (φ_{im}) = (service allocation bandwidth \times total number of users \times service user ratio \times concurrent ratio \times traffic duty ratio) / bandwidth redundancy factor)

(1) Concurrency ratio: It can be set according to the actual situation of different regions and different customer groups, always setting as 1/2.

(2) Flow duty ratio: generally, 50%.

(3) Bandwidth redundancy factor: setting as 65%.

3.4.3 GA algorithm

In this thesis, it's not easy to determine the type of this problem, so that this thesis choose GA algorithm to get the solution of this problem. The genetic algorithm is a search algorithm for simulating biological evolution processes and genetic manipulations on a computer. It is achieved by simulating phenomena such as hybridization and mutations that occur during natural selection and evolutionary genetic processes. When solving problems with genetic algorithms, we encode all possible solutions to the problem into strings, i.e. chromosomes. At the beginning of the genetic algorithm, some individuals are randomly selected to generate an initial population. Then each individual obtains their own evaluations results according to the specified objective function, and calculating their respective fitness values. According to this fitness value, an excellent individual is selected and copied to produce the next generation. Taking the natural principle of the survival of the fittest as the operating principle in the basic operation of the genetic algorithm, those who have the greatest chance to be selected for replication are those who are excellent, and those who are eliminated are the poor individuals. These new individuals are inferior to their ancestors for obtained through the above operations in some performances because they inherit the superior genes of their ancestors, and thus gradually evolve toward a better direction. The genetic algorithm is mainly composed of five elements: parameter coding, population initialization, fitness function determination, genetic operation setting and control parameter setting^[19].

The basic operation flow chart of the genetic algorithm is shown in the figure 3-8.

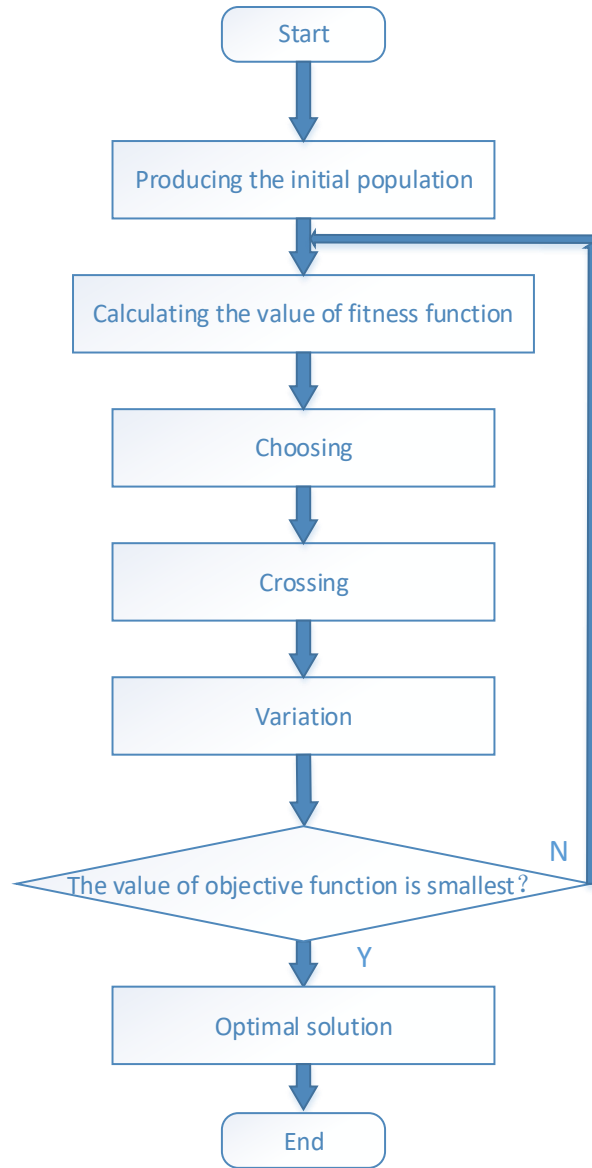

Figure 3-8 the progress of genetic algorithm

3.6 Case study

In this thesis, for the IEEE33 nodes distribution network, the typical wiring mode is adopted, and the distribution automation construction mode is flexibly selected. It is proved that the method of selecting the appropriate proportion of important nodes in power grid to optimize is used to

optimize the communication network of the 33-node distribution network and improve the reliability. In this thesis, the important nodes of the 33-node system are selected according to different proportions, and then the communication nodes corresponding to these nodes are optimized.

3.6.1 Results of topology

1) the results when the ratio of important node set as 0.2

As shown in figure 3-9, the blue lines are original communication network. Choosing 20% important nodes to provide them with dual linkage protection, whose another cable connected to another OLT are described by red lines. Obviously, with the ratio of important node is increasing, planners should adopt more than one ODNs. According to relevant technical requirements, the number of nodes, the practical results, when ratio is over 0.5, the optimal scheme should include more than one OLT. In figure 3-15,3-18,3-21, the optimal scheme includes more than one OLTs.

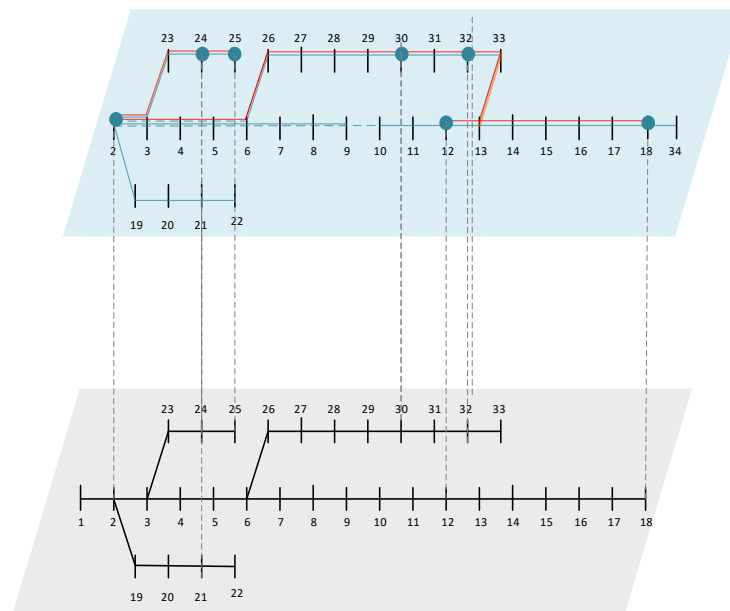

Figure 3-9 the communication planning scheme in ratio=0.2

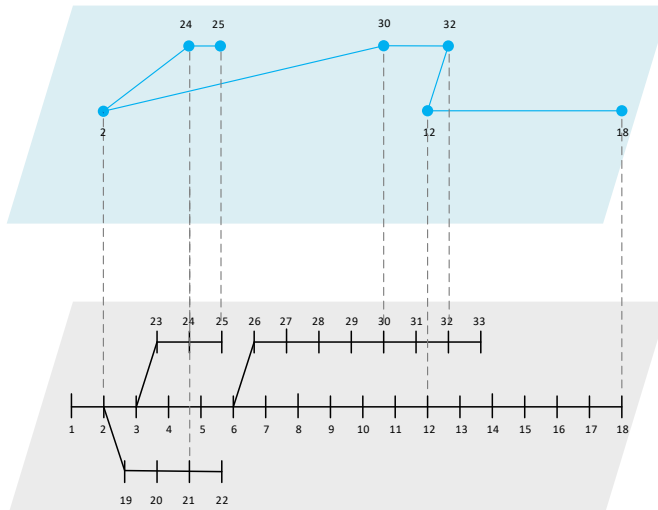

Figure 3-10 the abstract diagram of new cable lines in rate=0.2

2) the results when the ratio of important node set as 0.3

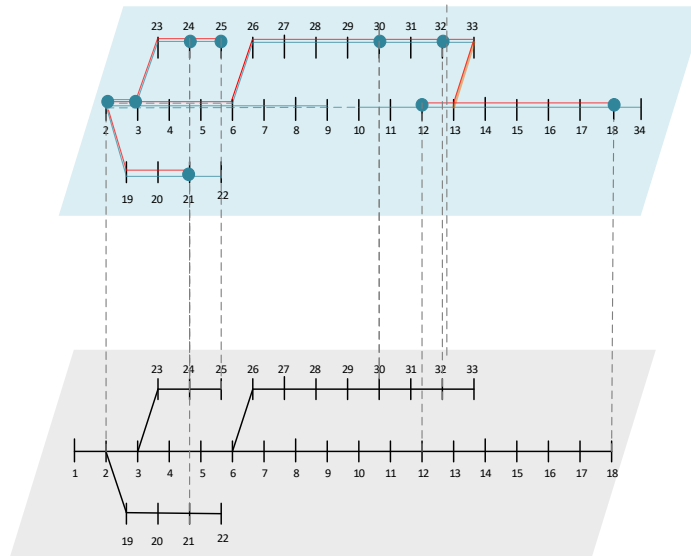

Figure 3-11 the communication planning scheme in ratio=0.3

As shown in figure 3.9, the optimal scheme includes the new cable trench from node 33 to node 13, which could reflect the necessity of considering the cost of cable laying in the model.

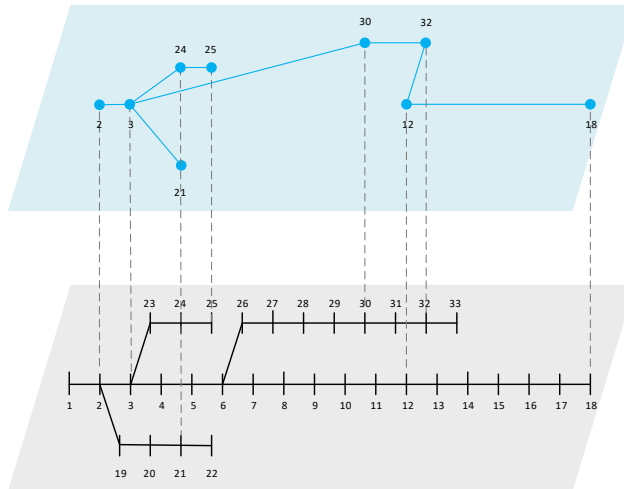

Figure 3-12 the abstract diagram of new cable lines in ratio=0.3

3) the results when the ratio of important node set as 0.4

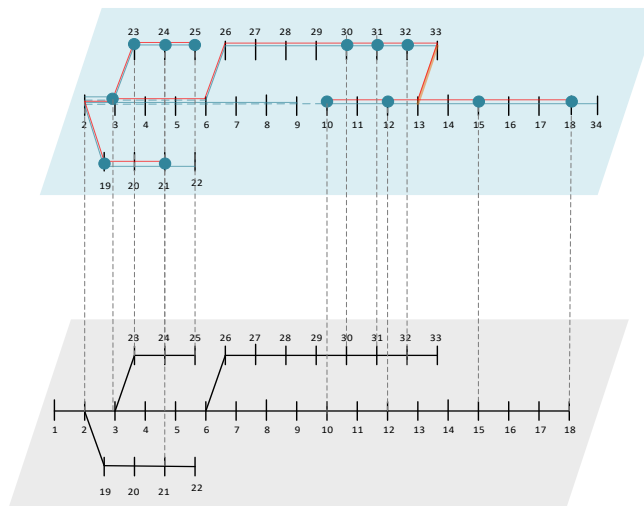

Figure 3-13 the communication planning scheme in ratio=0.4

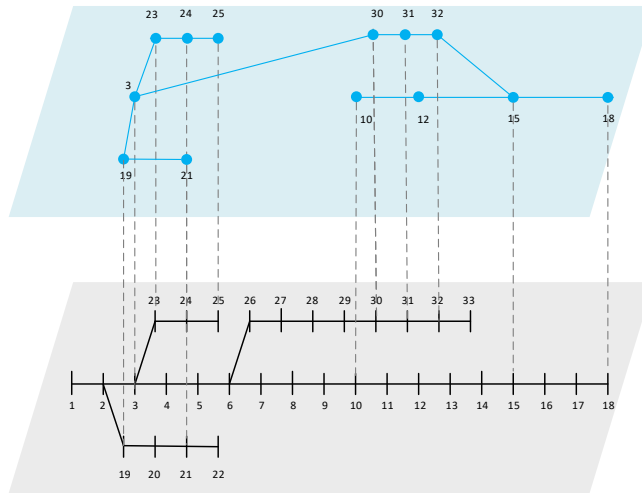

Figure 3-14 the abstract diagram of new cable lines in ratio=0.4

4) the results when the ratio of important node set as 0.5

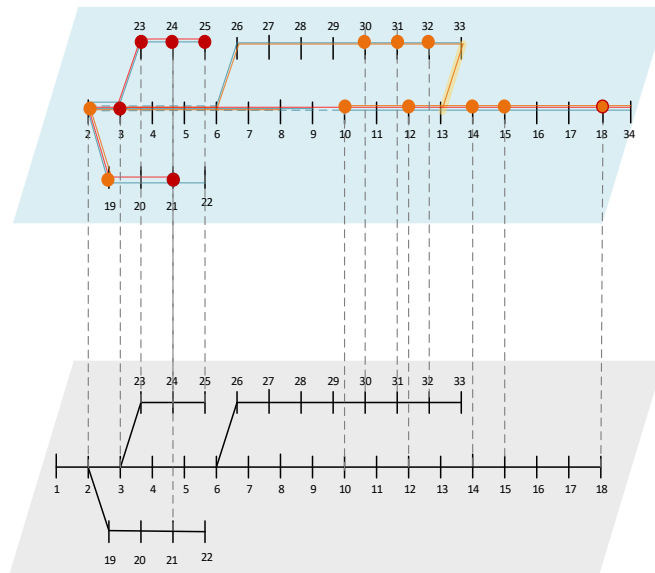

Figure 3-15 the communication planning scheme in ratio=0.5

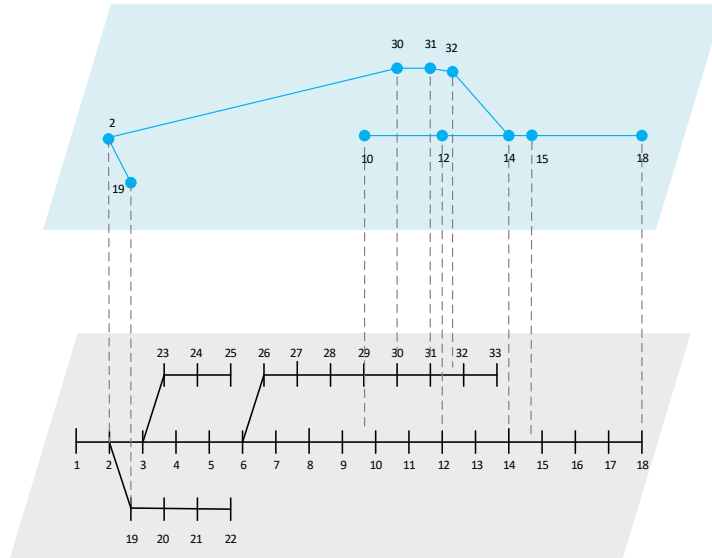

Figure 3-16 the abstract diagram of new cable lines in ratio=0.5

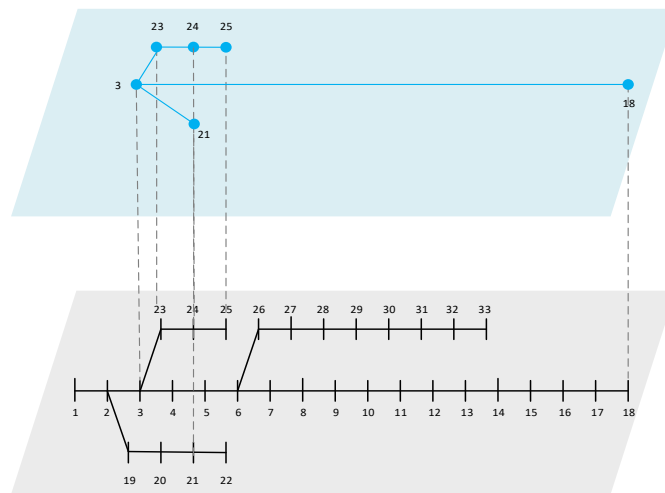

Figure 3-17 the abstract diagram of new cable lines in ratio=0.5

5) the results when the ratio of important node set as 0.6

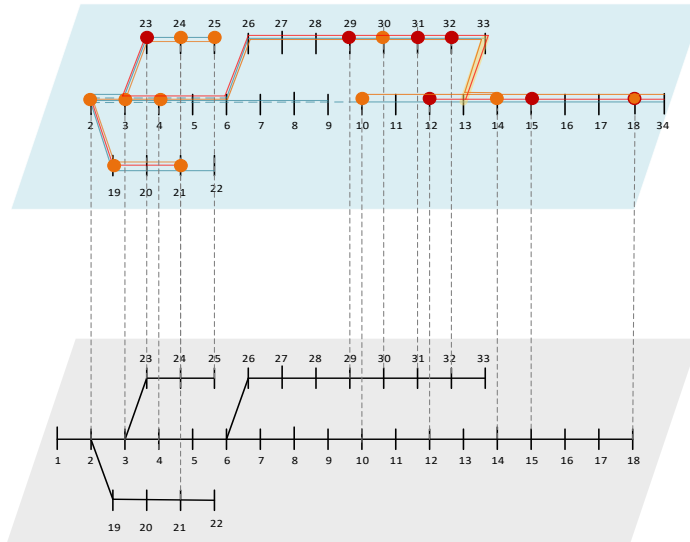

Figure 3-18 the communication planning scheme in ratio=0.6

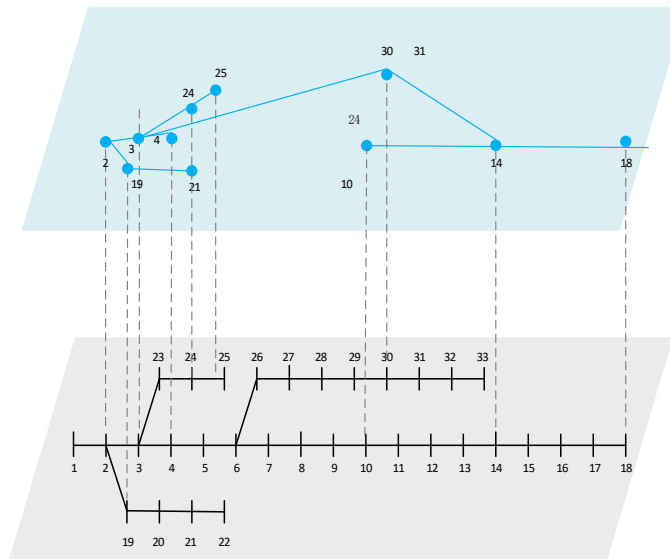

Figure 3-19 the abstract diagram of new cable lines in ratio=0.6

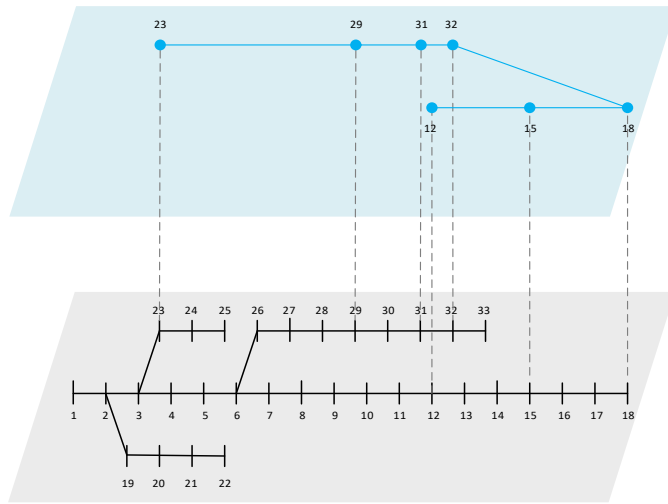

Figure 3-20 the abstract diagram of new cable lines in ratio=0.6

6) the results when the ratio of important node set as 0.6

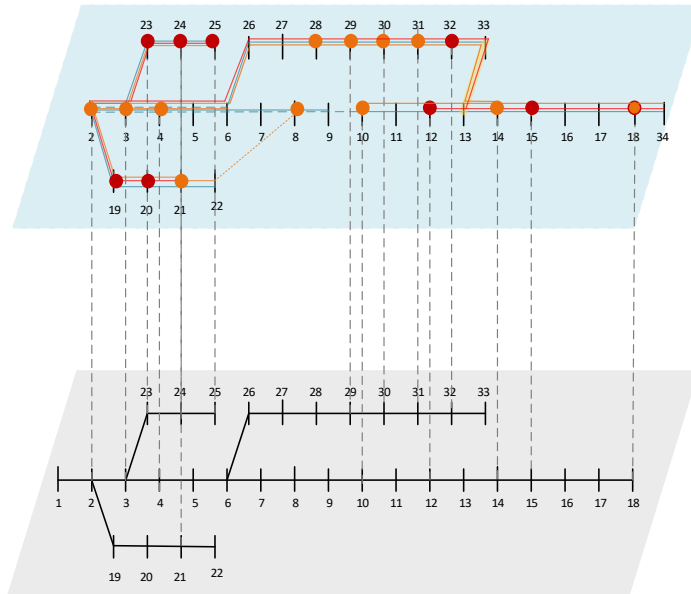

Figure 3-21 the communication planning scheme in ratio=0.7

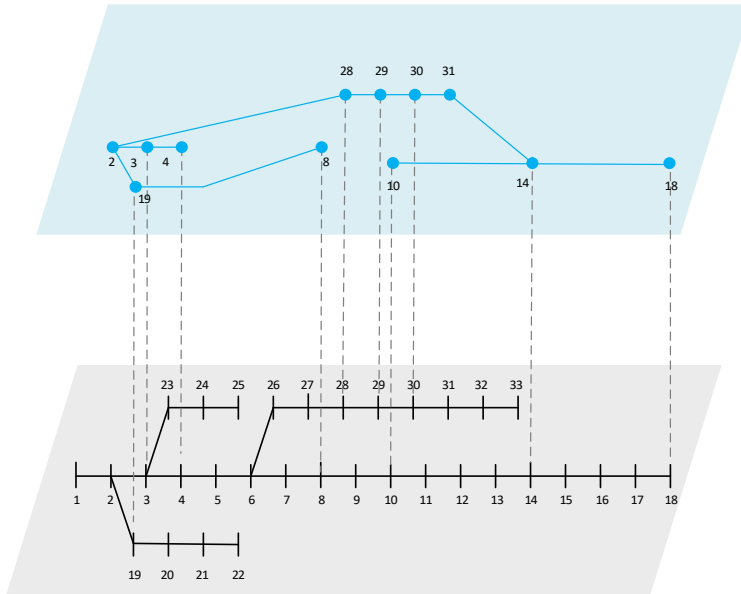

Figure 3-22 the abstract diagram of new cable lines in ratio=0.7

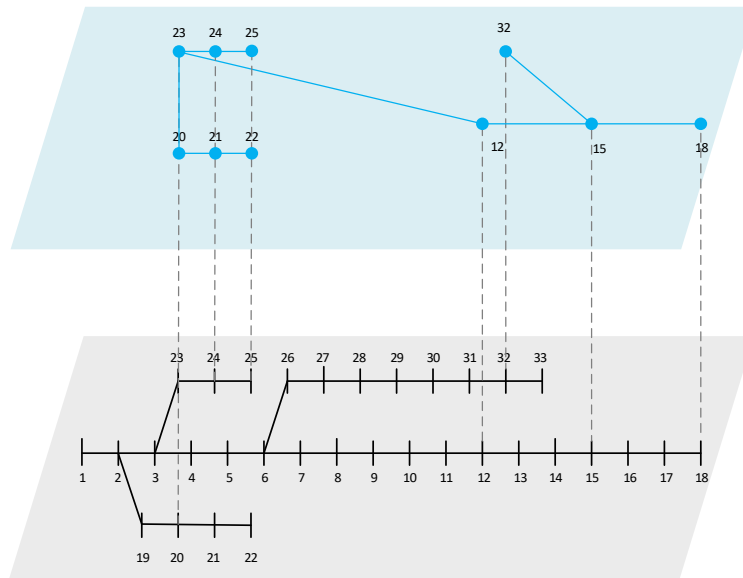

Figure 3-23 the abstract diagram of new cable lines in ratio=0.7

As shown in figure 3-9 to 3-23, the topology of distribution network has changed with the increase of the ratio of selecting important node. When the ratio over 0.4, to satisfy the technical requirement, topology has gradually evolved into two subsystem that called ODN in communication system. Sometimes, the optimal topology includes dotted lines in the abstract

figure as the proposed optimal algorithm compares the cost of using new constructed cable lines or old cable lines with the price of longer optical fiber.

3.6.2 Investment of optimization

Table 2 Cost of different ratio

The Ratio of	0.2	0.3	0.4	0.5	0.6	0.7
important node						
Investment (\$)	16,715	17,670	19,222	20,472	22,855	25,458

3.6.3 The results of reliability

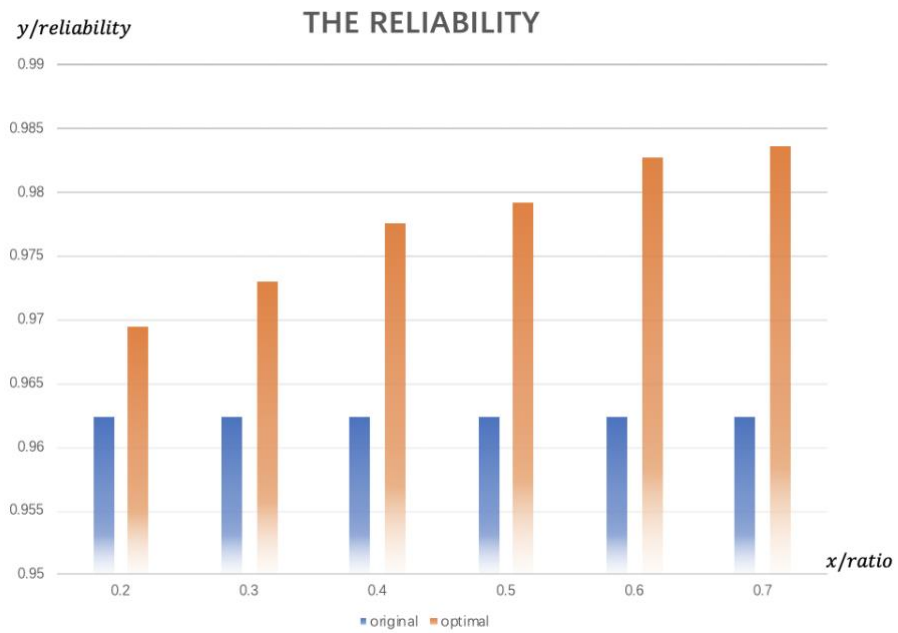

Figure 3-24 The change of reliability after optimization

In communication network, the most important is the connectivity of the channel between the ONU and OLT. In this figure, choosing the average value of the reliability all edges in communication network. In figure 3-24, it is clear that the reliability of whole communication system has been significantly improved after using the model proposed in this thesis to optimize the topology of communication network. At the very beginning, the reliability of original network is 0.9623, when setting ratio as 0.7, the average reliability of whole network is over 0.98, which is a great improvement.

Table 3 Network component failure rates and availability

Component	Availability
OLT	0.9997334
ONU	0.9998667
POS	0.9980000
Optical Fiber	0.9996001

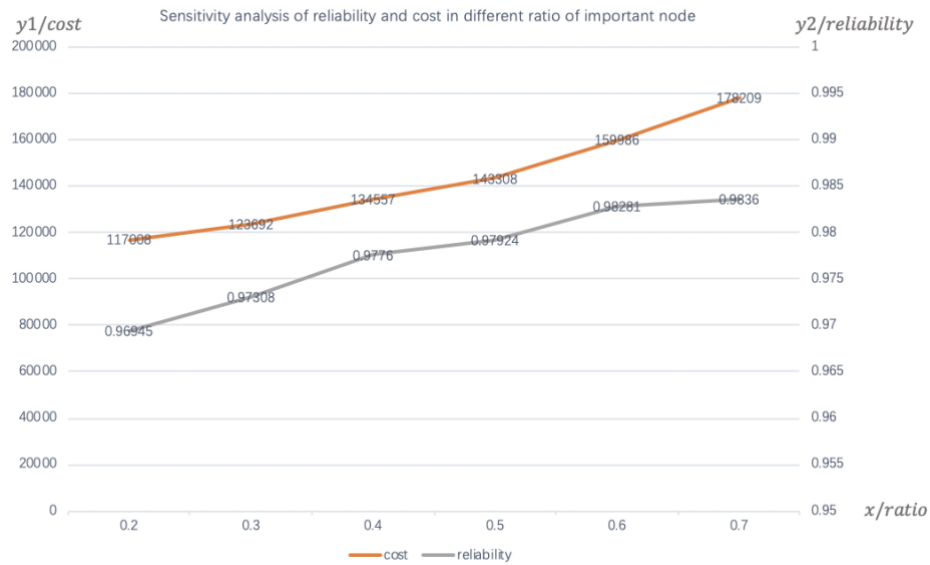

Figure 3-25 Sensitivity analysis of reliability and cost

As is shown in figure 3-25, in order to improve the reliability of the distribution communication network, more investment is needed. According to the different ratio of important node in the physical level, if planners choose to protect more nodes by giving dual link protection, the reliability of distribution communication network will increase at the price of more investment. Especially, when choose more than half nodes to add dual protection linkage, the cost has risen sharply, and at the same time, the reliability of the system has not increased rapidly. And the reliability of whole system is 0.96233, which has at least increase to 0.96945 after adopting dual linkage protection.

3.6.4 Analysis of results

According to the results section 3.6.2, it shows that the reliability of IEEE test 33 nodes

system could be improved by adding another link to another OLT on some nodes. According to figure 3.20, it is not necessary to choose so many nodes. the ratio of important nodes under 0.5 is enough, which could improve the reliability of system to a large extent and cost will not too high. As for some important node, such as node 2, the value of reliability of this node improve obviously, which indicates that the dual link strategy could improve the reliability of important node. In addition, it is obvious that if planner continue to increase investment, the effect of reliability improvement is not obvious, especially after the ratio of important nodes over 0.6.

Chapter4. Link Entropy

4.1 Introduction of LE

4.1.1 Definition and description of entropy

There are two related definitions of entropy: the thermodynamic definition and the statistical mechanics definition. Historically, the classical thermodynamics definition developed firstly. According to the classical thermodynamics viewpoint, the system is composed of large numbers of constituents (atoms, molecules) and the state of the system is described by the average thermodynamic properties of those constituents; the details of the system's constituents are not directly considered, but their behavior is described by macroscopically averaged properties, e.g. temperature, pressure, entropy, heat capacity. The early classical definition of the properties of the system assumed equilibrium. The classical thermodynamic definition of entropy has more recently been extended into the area of non-equilibrium thermodynamics. Later, the thermodynamic properties, including entropy, were given an alternative definition in terms of the statistics of the motions of the microscopic constituents of a system — modeled at first classically, e.g. Newtonian

particles constituting a gas, and later quantum-mechanically (photons, phonons, spins, etc.). The statistical mechanics description of the behavior of a system is necessary as the definition of the properties of a system using classical thermodynamics becomes an increasingly unreliable method of predicting the final state of a system that is subject to some process.

4.1.2 Definition and description of link entropy

It is undeniable that using more information of a network such as its linkage and topology could contribute to better quantitative indicator of maintaining global connectivity. In practical communication network, topology information like node and edge attributes are not easy to obtain [33-34]. Therefore, it's very important to focus on how to make full use of the topological information and especially how to choose and take advantage of key information. Notice the fact that an edge between two communities is significant on maintaining connectivity for the components, especially for some important node. As to an edge inside the community, there are other paths reachable between two endpoints when it breaks down. So, edges between communities are supposed to get more attention. What's more, how to quantify the significance of an edge is a key point [35].

4.2 The index of Link Entropy

In this thesis, we propose the Nonnegative Matrix Factorization method [48], which is obtain from to topology of network. And then according to the result of the NMF method, applying QS (Quantification Strategy) to calculate the values of Link Entropy of all edges to quantify their significance on maintaining global connectivity.

4.2.1 Strategy 1—Nonnegative Matrix Factorization

A network can be modelled as a graph $G = (V, E)$, where V is a set of n nodes and E is a set of m edges. In the analysis of power grid and communication network, it considers two networks as undirected and unweighted graphs whose adjacency matrix can be represented as a nonnegative symmetric binary matrix A . When there is a connection between node i and node j , the element a_{ij} in adjacency matrix A equals 1; if $i = j$, the element $a_{ii} = 0$ for any $1 \leq i \leq n$. We assume that the pairwise interactions described in A are influenced by an unobserved expectation network \hat{A} , where \hat{a}_{ij} is an observed variable which denotes the probability of existing a connection between nodes i and node j . Here we define x_{ik} as the probability that node i belongs to community k . So, an expected edge \hat{a}_{ij} can be estimated as

$$\hat{a}_{ij} = \sum_{k=1}^K x_{ik}x_{jk} \quad (4.1)$$

Using the matrix form to represent the above formula

$$\hat{A} = XX^T \quad (4.2)$$

As a result, we can use Nonnegative Matrix Factorization method to get X . X is a probability matrix, each row of X represents the probability of each node belonging to different communities? This thesis chooses two community. In this certain problem, using square loss function to measure the difference between the observed matrix A and the expected matrix \hat{A} , and define the following optimization problem as below formula

$$X = \underset{x \gg 0}{\operatorname{argmin}} \|A - \hat{A}\|^2 \quad (4.3)$$

4.2.2 Strategy 2—QS (Quantification Strategy)

According to the meaning of X referred above, X_i indicates the probability distribution of the node i , this indicator could show the relationship and significance of each node in different community, which is power grid and communication network in this thesis. Furthermore, in order to quantify the importance of edges linked with two network or two nodes in one network, nodes are usually important which are significant on maintaining connectivity. To design a quantitative measure to rank the significance of edges, we make use of information entropy and Jensen-Shannon divergence of the node probability distribution. The index of information entropy aims to find out overlapping nodes, and the second index focuses on measuring the divergence between two probability distributions. The method of Jensen-Shannon divergence is adopted to find the edges between two low-information-entropy nodes, which obviously belong to two different communities. Information entropy and Jensen-Shannon divergence used in this thesis are as follows:

$$H(X_i) = -\sum_{k=1}^K x_{ik} \log x_{ik} \quad (4.4)$$

Here, $H(X_i)$ is the information entropy of node i , which represents the probability a certain node belongs to one of the k communities. In this thesis, we set k as 2, since considering power system and communication system. The value of $H(X_i)$ could reflect the influences of overlapping nodes clearly, which means that its value is higher, this node is on an overlapping location between those two communities.

$$JSD(X_i||X_j) = \frac{1}{2}D(X_i||M) + \frac{1}{2}D(X_j||M) \quad (4.5)$$

Here, we could use the Jensen-Shannon divergence to describes the importance of each node in keep global connection, especially for those nodes that in the boundary of community.

$$M = \frac{1}{2}(X_i + X_j) \quad (4.6)$$

$$D(X_i||M) = \sum_{k=1}^K x_{ik} \log \frac{x_{ik}}{m_k} \quad (4.7)$$

$$LE_{ij} = \frac{(H(X_i)+H(X_j))/2+JSD (X_i||X_j)}{2} \quad (4.8)$$

LE method could quantify the significance of each edge on contribution on the total two networks. According to the calculation formula of LE_{ij} ,it is consisting of two part. These two parts consider two conditions including overlapping and boundary location. And using the value of M as the reference value in the process of calculating $H(X_i)$ and $JSD (X_i||X_j)$, so that the value of these two parts could be unified in one formula.

4.2.3 Case study

In this chapter, the ratio of important node sets as 0.4. The optimal network shows as figure 3-14. According to formula (4.1), (4.2), we could get the solution of X by using the Yalmip solver. And then the two part of LE_{ij} is calculated by X with formula (4.3), (4.4), the result is shown in table 3. According to the results of below table, some edges with high value of LE_{ij} is more important in the network, which need planners or operators pay more attention to these edges.

Table 4 the value of LE_{ij} when ratio=0.4

Node i	Node j	LE_{ij}	Node i	Node j	LE_{ij}
1	2	0.3767	1	2	0.3767
2	3	0.2058	2	3	0.2058
3	4	0.4003	3	4	0.4003
4	5	0.4937	4	5	0.4937
5	6	0.5006	5	6	0.5006
6	7	0.4963	6	7	0.4963
7	8	0.4913	7	8	0.4913
8	9	0.4907	8	9	0.4907
2	10	0.371	2	10	0.371
10	11	0.4988	10	11	0.4988
11	12	0.483	11	12	0.483
12	13	0.4263	12	13	0.4263
13	14	0.4221	13	14	0.4221
14	15	0.4542	14	15	0.4542
15	16	0.4711	15	16	0.4711
16	17	0.479	16	17	0.479
17	18	0.4829	17	18	0.4829
2	19	0.3312	2	19	0.3312
19	20	0.473	19	20	0.473
20	21	0.4967	20	21	0.4967
8	22	0.4936	8	22	0.4936
21	22	0.5014	21	22	0.5014
3	23	0.3725	3	23	0.3725
23	24	0.4633	23	24	0.4633
24	25	0.4929	24	25	0.4929
2	26	0.3453	2	26	0.3453
26	27	0.4866	26	27	0.4866
27	28	0.5014	27	28	0.5014
28	29	0.4978	28	29	0.4978
29	30	0.4957	29	30	0.4957
30	31	0.4885	30	31	0.4885
31	32	0.4689	31	32	0.4689
32	33	0.453	32	33	0.453
13	33	0.4261	13	33	0.4261

2	25	0.0816	2	25	0.0816
3	36	0.1799	3	36	0.1799
4	37	0.4677	4	37	0.4677
5	38	0.5013	5	38	0.5013
6	39	0.4964	6	39	0.4964
35	36	0.3351	35	36	0.3351
36	37	0.3351	36	37	0.3351
37	38	0.4902	37	38	0.4902
38	39	0.5005	38	39	0.5005
25	58	0.49982	25	58	0.49982
35	59	0.3195	35	59	0.3195
26	59	0.4541	26	59	0.4541
27	60	0.5002	27	60	0.5002
59	60	0.4841	59	60	0.4841
8	41	0.4853	8	41	0.4853
39	41	0.4908	39	41	0.4908
40	41	0.4923	40	41	0.4923
55	41	0.4956	55	41	0.4956
9	42	0.4943	9	42	0.4943

4.3 Conclusion

To facilitate understanding, we sort ideas mentioned above as the following three views. Firstly, the edges linked with overlapping nodes are of great significance on maintaining global connectivity. Secondly, the edges between the boundaries of communities are of great significance on maintaining global connectivity. Thirdly, the larger the value of LE is, the greater the edge significance is. Ultimately, we just average the value that we get in the above-mentioned two aspects as the values of edge significance on maintaining global connection between power grid and communication network.

Chapter5. Conclusion and Future Work

5.1 Conclusion

This thesis studies the EPON communication topology planning based on node importance of active distribution network, and calculates the reliability indices and importance of LE for the optimal system as well.

Firstly, characteristics of power grid are considered into the new index proposed in this thesis. In the stable operating environment, planner choose the typical operating condition as the original network. Then, a case study is carried out. First, the 33-node IEEE test system is simplified by using the topology, and the energy change volumes are calculated by a simplified method. The results of this new indicator show that, some nodes in power grid take more responsibility with more load or more access of DGs. Then, an optimization model is established to find the optimal network of communication network based on EPON. This model aims to improve the reliability of communication network by providing some important nodes another link to another OLT, which will increase the investment to some extent. In a word, planning work should take a balance between the reliability of communication network depends on the topology connection and the cost of construction new fibers.

Secondly, the sensitivity analyses study related to the reliability and the cost are carried out. The results show that, the improvement of reliability is significant when the ratio of important node is relatively low, and the cost is largely increased after ratio over 0.6. The results show that choosing a certain ratio of important node to add double-link protection is reasonable than

traditionally providing all nodes with dual linkage protection.

Lastly, using the entropy theory to analyze the optimal results, which means that analyzing whole network from another perspective. According to the Link Entropy index, we could quantify the important edges in the optimal network, which further help planner to protect distribution communication network.

5.2 Future Work

Future work can be focused on the following aspects:

- Considering the control characteristic of DGs and DRs in the distribution power system, and studying the impact of this characteristic on the node importance of distribution power network;
- Revising the proposed indicator that reflects the importance of each node with the characteristics of distribution network;
- Using the Monte Carlo method to improve the accuracy of calculating the availability of a single component, comparing to the results of the enumeration method;
- Choosing or proposing a systematic reliability indicator for evaluating the overall performance of the system after optimization the topology;
- Adjusting the scale of the case study and applying the optimization model to a large system with different topologies, such as IEEE 118 system.
- Studying the power grid vulnerability and resiliency in the presence of cyber-physical attacks from the perspective of complex networks.

References

- [1] Y. Qian, Y. Li, M. Zhang, et al. "Quantifying edge significance on maintaining global connectivity." *Scientific Reports*, 2017, 7:45380.
- [2] W. Liu, et al. "Reliability Modeling and Evaluation of Active Cyber Physical Distribution System." *IEEE Transactions on Power Systems*, vol. 33, no. 6, 2018, pp. 7096–7108.
- [3] X. Chen, et al. "The Evolution Trends of PON and Key Techniques for NG-PON." 2013 9th International Conference on Information, Communications & Signal Processing, 2013, pp. 1–6.
- [4] Falahati, Bamdad, et al. "Evaluating the Differences between Direct and Indirect Interdependencies and Their Impact on Reliability in Cyber-Power Networks." 2017 IEEE Conference on Technologies for Sustainability (SusTech), vol. 2018, 2017, pp. 1–6.
- [5] X. Dong, et al. "Planning-Operation Co-Optimization Model of Active Distribution Network with Energy Storage Considering the Lifetime of Batteries." *IEEE Access*, vol. 6, 2018, pp. 59822–59832.
- [6] J. Zhang, and S. Min. "Reliability Assessment of Distribution Network System Considering Output Uncertainties of Distributed Generators." *Journal of Physics: Conference Series*, vol. 1087, 2018, p. 042017.
- [7] C. Li, et al. "Coordinated Control Strategy of Distributed Generation Based on Active Distribution Network under Multi-Time Scales." 2016 International Conference on Smart City and Systems Engineering (ICSCSE), 2016, pp. 417–420.
- [8] Liu, Wenxia, et al. "Collaborative Planning of DERs and Intentional Islands in Distribution Network Considering Loss-of-Load Risk." *IEEE Access*, vol. 6, no. 99, 2018, pp. 45961–45973. 20
- [9] D. Song, and K. Wang. "An Overview on Key Technologies of Secure and Efficient Data Transmission for Energy Internet." 2017 IEEE 15th Intl Conf on Dependable, Autonomic and Secure Computing, 15th Intl Conf on Pervasive Intelligence and Computing, 3rd Intl Conf on Big Data Intelligence and Computing and Cyber Science and Technology Congress(DASC/PiCom/DataCom/CyberSciTech), vol. 2018, 2017, pp. 340–345.
- [10] X. Zhao, et al. "A Method of Fast Locating the Key Nodes Based on the Distribution Law of Node's Propagation Domain." 2018 IEEE Third International Conference on Data Science in Cyberspace (DSC), 2018, pp. 902–909.
- [11] J. Li, et al. "Research on Technical Framework of Smart Distribution Network." 2011 International Conference on Advanced Power System Automation and Protection, vol. 1, 2011, pp. 286–290.
- [12] D. Wang, et al. "Cyber-Physical Security Assessment and Simulation Based on Graph Database." 2017 IEEE Conference on Energy Internet and Energy System Integration (EI2), vol. 2018, 2017, pp. 1–6.
- [13] F. Rong, et al. "Security Assessment for Cyber Physical Distribution Power System under Intrusion Attacks." *IEEE Access*, PP, no. 99, 2018, p. 1.
- [14] R. Li, W. Wang and M. Xia. "Cooperative Planning of Active Distribution System With Renewable Energy Sources and Energy Storage Systems." *IEEE Access*, vol. 6, pp. 5916-5926, 2018.
- [15] X. Shen, M. Shahidehpour, S. Zhu, Y. Han and J. Zheng. "Multi-Stage Planning of Active Distribution Networks Considering the Co-Optimization of Operation Strategies." *IEEE Transactions on Smart Grid*, vol. 9, no. 2, pp. 1425-1433, March 2018.

-
- [16] Y. Tan, J. Wu, H. Deng. "Evaluation method for node importance based on node contraction in complex networks." *Systems Engineering — Theory & Practice*, 2006, 26(11): 79-83.
- [17] S. Jia, et al. "Improved Method of Node Importance Evaluation Based on Node Contraction in Complex Networks." *Procedia Engineering*, vol. 15, 2011, pp. 1600–1604.
- [18] Alhamali, M. E. Farrag, G. Bevan and D. M. Hepburn. "Determination of optimal site and capacity of DG systems in distribution network based on genetic algorithm." 2017 52nd International Universities Power Engineering Conference (UPEC), Heraklion, 2017, pp. 1-6.
- [19] Z. Liu, Y. Wang, W. Li, S. Xu, W. He and K. Sun. "A planning method of clustering ONUs based on reliability." 2017 16th International Conference on Optical Communications and Networks (ICOON), Wuzhen, 2017, pp. 1-3.
- [20] Y. Shi, S. Guo, Q. Xue and F. Qi, "Optimal planning of power distribution communication network using genetic algorithm." 2014 IEEE International Conference on Communications (ICC), Sydney, NSW, 2014, pp. 3676-3681.
- [21] Y. Hu and X. Zhou, "CPS-Agent Oriented Construction and Implementation For Cyber Physical Systems." in *IEEE Access*, vol. 6, pp. 57631-57642, 2018.
- [22] Hughes, J.W, and D.W Von Dollen. "Developing an Integrated Energy and Communications Systems Architecture: the Initial Steps." *IEEE PES Power Systems Conference and Exposition*, 2004, 2004, pp. 1651–1654 vol.3.
- [23] Sridhar, S, et al. "Cyber-Physical System Security for the Electric Power Grid." *Proceedings of the IEEE*, vol. 100, no. 1, 2012, pp. 210–224.
- [24] J. Zhao, F. Wen, Y. Xue, et al. "Cyber physical power systems: architecture, implementation techniques and challenges." *Automation of Electric Power Systems*, 2010, 34(16):1-7.
- [25] X. Dong, S. Yi, X. Jing and H. Jiarui. "A comprehensive evaluation method for active distribution network," 2016 China International Conference on Electricity Distribution (CICED), Xi'an, 2016, pp. 1-4.
- [26] X. Bao, et al. "Analysis of Reliability and Cost Performance of EPON Protection Network in Access Layer of Distribution Communication Network." *Power System Automation* 37.8(2013): 96-101.
- [27] Ancillotti, et al. "The Role of Communication Systems in Smart Grids: Architectures, Technical Solutions and Research Challenges." *Computer Communications*, vol. 36, no. 17-18, 2013, pp. 1665–1697.
- [28] K. Wang, B. Zang, Z. Zhang, et al. "An Electrical Betweenness Approach for Vulnerability Assessment of Power Grids Considering the Capacity of Generators and Load." *Physica A: Statistical Mechanics and Its Applications*, vol. 390, no. 23-24, 2011, pp. 4692–4701.
- [29] Y. Guo, M. Xu . "Research on Reliability Evaluation Model and Path Optimization for Power Communication Network." 2015 5th International Conference on Electric Utility Deregulation and Restructuring and Power Technologies (DRPT), 2015, pp. 2495–2500.
- [30] Kaur, Hardeep, M. L Singh. "Performance Analysis of Mobile WiMax for Frequency Selective Fading Channel Models." 2016 International Conference on Communication and Signal Processing (ICCSP), 2016, pp. 1889–1892.
- [31] Z. Xie Z, et al. "An Information Architecture for Future Power Systems and Its Reliability Analysis." *IEEE Transactions on Power Systems*, vol. 17, no. 3, 2002, pp. 857–863.

-
- [32] Z. Zhao, et al. "Reliability Evaluation of Power Communication Network Based on FAHP and Entropy Method." 2010 2nd International Workshop on Intelligent Systems and Applications, 2010, pp. 1–4.
- [33] Hughes, J.W, and D.W Von Dollen. "Developing an Integrated Energy and Communications Systems Architecture: the Initial Steps." IEEE PES Power Systems Conference and Exposition, 2004, 2004, pp. 1651–1654 vol.3.
- [34] Hauser, C.H, et al. "A Failure to Communicate: next Generation Communication Requirements, Technologies, and Architecture for the Electric Power Grid." IEEE Power and Energy Magazine, vol. 3, no. 2, 2005, pp. 47–55.
- [35] Y. Zheng, Z. Mao, L. Di, Z. Ge, X. Zhang and X. Sun. "Low latency passive optical node for optical access network." 2017 16th International Conference on Optical Communications and Networks (ICOON), Wuzhen, 2017, pp. 1-2.
- [36] Lavery, Domanic, et al. "Reduced Complexity Equalization for Coherent Long-Reach Passive Optical Networks [Invited]." IEEE/OSA Journal of Optical Communications and Networking, vol. 7, no. 1, 2015, pp. A16–A27.
- [37] A. A. gate and K. Nishimura. "Suboptimal PON network designing algorithm for minimizing deployment cost of optical fiber cables." 2012 16th International Conference on Optical Network Design and Modelling (ONDM), Colchester, 2012, pp. 1-6.
- [38] An Vu Tran, R, et al. "Ethernet PON or WDM PON: A Comparison of Cost and Reliability." TENCON 2005 - 2005 IEEE Region 10 Conference, vol. 2007, 2005, pp. 1–6.
- [39] Klüver, Jürgen. "A Mathematical Theory of Communication: Meaning, Information, and Topology." Complexity, vol. 16, no. 3, 2011, pp. 10–26.
- [40] L. Li L, X.Wu, K. Wu and X. Zhu. "Graph theory with Modify-edge Clustering Algorithm Based on Maximum Weighted Entropy." 2006 6th World Congress on Intelligent Control and Automation, Dalian, 2006, pp. 9730–9733.
- [41] Shannon, C. "A Mathematical Theory of Communication." ACM SIGMOBILE Mobile Computing and Communications Review, vol. 5, no. 1, 2001, pp. 3–55.
- [42] Buldyrev, Sergey, et al. "Catastrophic Cascade of Failures in Interdependent Networks." Nature, vol. 464, no. 7291, 2010, pp. 1025–8.
- [43] Z. Xie, G, et al. "An Information Architecture for Future Power Systems and Its Reliability Analysis." IEEE Transactions on Power Systems, vol. 17, no. 3, 2002, pp. 857–863.
- [44] G. Manimaran, V. Vittal. "An information architecture for future power systems and its reliability analysis." IEEE Transactions on Power Systems, 2002, 17(3): 857–863.
- [45] M. Zotkiewicz. "Optimizing Backup Fibers in Passive Optical Networks." 2018 20th International Conference on Transparent Optical Networks (ICTON), Bucharest, 2018, pp. 1-4.
- [46] Teixeira, A. Shahpari, J. D. Reis and R. Ferreira. "Flexible access networks." 2014 16th International Conference on Transparent Optical Networks (ICTON), Graz, 2014, pp. 1-3.
- [47] X. Chu, M. Tang, H. Huang and L. Zhang. "A security assessment scheme for interdependent cyber-physical power systems." 2017 8th IEEE International Conference on Software Engineering and Service Science (ICSESS), Beijing, 2017, pp. 816-819.

-
- [48] M. M. Tulu, R. Hou and T. Younas. "Identifying Influential Nodes Based on Community Structure to Speed up the Dissemination of Information in Complex Network." *IEEE Access*, vol. 6, pp. 7390-7401, 2018.
- [49] Y. Mo, et al. "Cyber-Physical Security of a Smart Grid Infrastructure." *Proceedings of the IEEE*, vol. 100, no. 1, 2012, pp. 195–209.
- [50] Bou-Harb, E, et al. "Communication Security for Smart Grid Distribution Networks." *IEEE Communications Magazine*, vol. 51, no. 1, 2013, pp. 42–49.