

May 2019

Anthropogenically Driven Changes to Shallow Groundwater in Southeastern Wisconsin and Its Effects on the Aquifer Microbial Communities

Madeline Jean Salo

University of Wisconsin-Milwaukee

Follow this and additional works at: <https://dc.uwm.edu/etd>

 Part of the [Geology Commons](#), and the [Hydrology Commons](#)

Recommended Citation

Salo, Madeline Jean, "Anthropogenically Driven Changes to Shallow Groundwater in Southeastern Wisconsin and Its Effects on the Aquifer Microbial Communities" (2019). *Theses and Dissertations*. 2116.
<https://dc.uwm.edu/etd/2116>

This Thesis is brought to you for free and open access by UWM Digital Commons. It has been accepted for inclusion in Theses and Dissertations by an authorized administrator of UWM Digital Commons. For more information, please contact open-access@uwm.edu.

ANTHROPOGENICALLY DRIVEN CHANGES TO SHALLOW GROUNDWATER IN
SOUTHEASTERN WISCONSIN AND ITS EFFECTS ON THE AQUIFER MICROBIAL
COMMUNITIES

by

Madeline J. Salo

A Thesis Submitted in
Partial Fulfillment of the
Requirements for the Degree of

Master of Science
in Geosciences

at

The University of Wisconsin-Milwaukee

May 2019

ABSTRACT
ANTHROPOGENICALLY DRIVEN CHANGES TO SHALLOW GROUNDWATER IN
SOUTHEASTERN WISCONSIN AND ITS EFFECTS ON THE AQUIFER

by

Madeline J. Salo

The University of Wisconsin-Milwaukee, 2019
Under the Supervision of Professor Timothy J. Grundl

This study investigates if, and to what extent, the microbial community present in the shallow groundwater of southeastern Wisconsin is affected by the influx of treated municipal wastewater effluent. The primary study area consisted of three wells located in the shallow sand and gravel aquifer along the upper Fox River in Waukesha, Wisconsin. One well is located roughly 1500 feet from the river and pumps pristine groundwater. Two riverbank inducement wells are located within 200 feet of the river and pump a mixture of groundwater and river water that contains effluent from three upstream wastewater treatment plants. Water from all three wells was analyzed for geochemical composition (major ions, nutrients, dissolved gases and dissolved organic carbon) and microbial community composition (16S rRNA gene composition, 16S rRNA activity and metagenomic sequencing). Geochemical and microbial community data were combined to identify thermodynamically feasible metabolic pathways capable of being carried out by the microbial consortia. Geochemical results show the riverbank inducement wells differ from the pristine well in thermodynamic capabilities. Microbial results show differences in the microbial consortia present in the pristine well and the riverbank inducement wells. Microbial community taxa identified with known subsurface microorganisms, recently discovered microorganisms from the CPR and DPANN superphyla, and unclassified unknown organisms.

© Copyright by Madeline J. Salo, 2019
All Rights Reserved

To my cousin Parker Jack Haire,

(who would have never read this)

for giving me 21 years of memories that I will never forget.

I love you.

TABLE OF CONTENTS

| | |
|---|----|
| ABSTRACT | ii |
| Chapter 1: Introduction..... | 1 |
| 1.1 History of the City of Waukesha..... | 2 |
| Chapter 2: Setting..... | 4 |
| 2.1 Study Area..... | 4 |
| 2.2 Climate and Precipitation..... | 6 |
| 2.3 Regional Geology..... | 6 |
| 2.4 Hydrostratigraphy..... | 6 |
| Chapter 3: Study Parameters | 9 |
| Chapter 4: Previous Research..... | 10 |
| 4.1 Previous Fox River Studies..... | 10 |
| 4.2 Previous Microbiology Studies..... | 13 |
| Chapter 5: Relevance and Research Objective..... | 16 |
| Chapter 6: Methods | 18 |
| 6.1 Monitoring Network..... | 18 |
| 6.2 Field Methods and Equipment | 19 |
| 6.3 Laboratory Methods..... | 22 |
| 6.4 Thermodynamic Calculations | 26 |
| Chapter 7: Results and Discussion | 32 |
| 7.1 Geochemical Analyses..... | 32 |
| 7.2 Thermodynamic Analyses..... | 35 |
| 7.3 Shallow Groundwater Well Differentiation..... | 38 |
| 7.4 Microbial Community Diversity Analyses | 44 |
| Chapter 8: Conclusions..... | 53 |
| References | 55 |
| Appendices | 59 |
| Appendix A: Sample Collection Information | 60 |
| Appendix B: Field and Analytical Results..... | 68 |

LIST OF FIGURES

| | |
|--|----|
| FIGURE 1. MAP OF THE FOX RIVER WATERSHED (FOX RIVER STUDY GROUP, INC. 2018)..... | 5 |
| FIGURE 2. GENERALIZED HYDROSTRATIGRAPHIC COLUMN FOR SOUTHEAST WISCONSIN (KLUMP ET AL., 2008)..... | 7 |
| FIGURE 3. CROSS SECTION SHOWING GENERAL HYDROGEOLOGY OF SOUTHEAST WISCONSIN (WAUKESHACOUNTY.GOV). | 8 |
| FIGURE 4. MAJOR ION CHEMISTRY IN WELL 11 FROM 2005 THROUGH 2015 (FIELDS-SOMMERS, 2015)..... | 11 |
| FIGURE 5. MAJOR ION CHEMISTRY IN WELL 12 FROM 2005 THROUGH 2015 (FIELDS-SOMMERS, 2015)..... | 11 |
| FIGURE 6. MAJOR ION CHEMISTRY IN WELL 13 FROM 2009 THROUGH 2015 (FIELDS-SOMMERS, 2015)..... | 12 |
| FIGURE 7. RBI WELLS PUMPING A MIX OF PRISTINE GROUNDWATER AND WWTP EFFLUENT (THORP, 2013)..... | 13 |
| FIGURE 8. MAP OF MONITORING NETWORK, WITH LIGHT GREEN INDICATING THE WATERSHEDS OF THE SAMPLING SITES (FIELDS-SOMMERS, 2015). | 19 |
| FIGURE 9. PIPER DIAGRAM FOR WELL 11. | 33 |
| FIGURE 10. PIPER DIAGRAM FOR WELL 12..... | 34 |
| FIGURE 11. PIPER DIAGRAM FOR WELL 13..... | 34 |
| FIGURE 12. FREE ENERGY FLUX LISTED IN ORDER FROM MOST TO LEAST IN THE PRISTINE WELL (WELL 13)..... | 39 |
| FIGURE 13. FREE ENERGY FLUX DISTRIBUTIONS FOR HETEROTROPHIC AND FERMENTATION METABOLIC PATHWAYS IN WELL 11 CALCULATED USING THE LIMITING REACTANT. LEGEND REPRESENTS REACTION NUMBERS DESCRIBED IN TABLE 4. | 40 |
| FIGURE 14. FREE ENERGY FLUX DISTRIBUTIONS FOR HETEROTROPHIC AND FERMENTATION METABOLIC PATHWAYS IN WELL 12 CALCULATED USING THE LIMITING REACTANT. LEGEND REPRESENTS REACTION NUMBERS DESCRIBED IN TABLE 4. | 40 |
| FIGURE 15. FREE ENERGY FLUX DISTRIBUTIONS FOR HETEROTROPHIC AND FERMENTATION METABOLIC PATHWAYS IN WELL 13 CALCULATED USING THE LIMITING REACTANT. LEGEND REPRESENTS REACTION NUMBERS DESCRIBED IN TABLE 4. | 41 |
| FIGURE 16. FREE ENERGY FLUX DISTRIBUTIONS FOR HETEROTROPHIC AND FERMENTATION METABOLIC PATHWAYS IN WELL 11 CALCULATED USING THE OVERALL LIMITING CONSTITUENT. LEGEND REPRESENTS REACTION NUMBERS DESCRIBED IN TABLE 4..... | 42 |
| FIGURE 17. FREE ENERGY FLUX DISTRIBUTIONS FOR HETEROTROPHIC AND FERMENTATION METABOLIC PATHWAYS IN WELL 12 CALCULATED USING THE OVERALL LIMITING CONSTITUENT. LEGEND REPRESENTS REACTION NUMBERS DESCRIBED IN TABLE 4..... | 43 |
| FIGURE 18. FREE ENERGY FLUX DISTRIBUTIONS FOR HETEROTROPHIC AND FERMENTATION METABOLIC PATHWAYS IN WELL 13 CALCULATED USING THE OVERALL LIMITING CONSTITUENT. LEGEND REPRESENTS REACTION NUMBERS DESCRIBED IN TABLE 4..... | 43 |

FIGURE 19. HEATMAP SHOWING THE RELATIVE ABUNDANCE OF BACTERIAL FAMILIES (ONLY FAMILIES PRESENT AT GREATER THAN 2% OF THE COMMUNITY COMPOSITION IN AT LEAST ONE SAMPLE DEPICTED)..... 45

FIGURE 21. NMDS ORDINATION OF FOX RIVER AND GROUNDWATER MICROBIAL COMMUNITY SAMPLES. 49

FIGURE 22. GROUNDWATER MICROBIAL COMMUNITY DENDROGRAM. NMDS AND BRAY-CURTIS DISSIMILARITY WERE USED TO GENERATE A DENDROGRAM DEMONSTRATING THE DIFFERENCES ACROSS GROUNDWATER MICROBIAL COMMUNITY SAMPLES. THE GROUNDWATER MICROBIAL COMMUNITIES CLUSTER FIRST BY WELL LOCATION IN THAT W12 IS SIGNIFICANTLY DIFFERENT FROM THE OTHER TWO WELLS. FILTER SIZE FRACTION THEN CLUSTER TOGETHER, THEN WELL 13 AND WELL 11 CLUSTER SEPARATELY, AND THEN RNA AND DNA CLUSTER TOGETHER. 51

LIST OF TABLES

| | |
|---|----|
| TABLE 1. NEGATIVE CONTROL REACTION COMPONENTS, CONCENTRATIONS, AND VOLUMES. | 26 |
| TABLE 2. PCR THERMOCYCLER CONDITIONS. | 26 |
| TABLE 3. COMPOSITE WATER QUALITY DATA FOR THREE SHALLOW GROUNDWATER WELLS WITH RESPECTIVE STANDARD DEVIATIONS FROM NOVEMBER 2016 THROUGH JANUARY 2018. | 28 |
| TABLE 4. BALANCED BIOGEOCHEMICAL REACTIONS. | 29 |
| TABLE 5. THE FREE ENERGY OF REACTION AND FREE ENERGY FLUX FOR A SET OF BIOGEOCHEMICAL REACTIONS. | 35 |
| TABLE 6. THE FREE ENERGY OF REACTION AND FREE ENERGY FLUX FOR ENERGETICALLY FAVORABLE BIOGEOCHEMICAL REACTIONS. | 38 |

LIST OF EQUATIONS

| | |
|--|----|
| EQUATION 1. $aA + bB \rightleftharpoons cC + dD$ | 29 |
| EQUATION 2. $\Delta G^\circ = \sum \Delta G^\circ_f(\text{PRODUCTS}) - \Delta G^\circ_f(\text{REACTANTS})$ | 30 |
| EQUATION 3. $K_{EQ} = E^{-(\Delta G^\circ/RT)}$ | 30 |
| EQUATION 4. $\Delta G_r = \Delta G^\circ + RT \ln Q$ | 30 |
| EQUATION 5. $Q = [C]^c [D]^d / [A]^a [B]^b$ | 30 |
| EQUATION 6. $FEF = 4\pi \cdot r \cdot D_c \cdot C \cdot \Delta G_r$ | 30 |

LIST OF ABBREVIATIONS

| | |
|--------------------|---|
| ΔG° | Gibbs free energy |
| ΔG°_f | Standard free energy of formation |
| ΔG_r | Gibbs free energy of reaction |
| ASV | Amplicon sequence variants |
| ATP | Adenosine triphosphate |
| C | Concentration |
| CPR | Candidate phyla radiation |
| D_c | Diffusion coefficient |
| DNA | Deoxyribonucleic acid |
| DPANN phylum | Diapherotrites, Parvarchaeota, Aenigmarchaeota, Nanoarchaeota, Nanohaloarchaea |
| DOC | Dissolved organic carbon |
| EPA | Environmental Protection Agency |
| FEF | Free energy flux |
| ID | Identification |
| K_{eq} | Equilibrium constant |
| NA | Not analyzed |
| ND | Non-detect |
| Q | Reaction quotient |
| R | Universal gas constant |
| r | Radius of the microbial cell |
| RBI | Riverbank inducement |
| RNA | Ribonucleic acid |
| SRP | Spectrophotometer |
| T | Temperature |
| TDP | Total dissolved phosphorous |
| U | Enzyme unit, the amount of the enzyme that produces a certain amount of enzymatic activity or the amount that catalyzes the conversion of 1 micromole of substrate per minute |
| WDNR | Wisconsin Department of Natural Resources |
| WWTP | Wastewater treatment plant |

LIST OF UNITS

| | |
|--|-----------------------------------|
| °C | degree Celsius |
| °K | degree Kelvin |
| μL | Microliter |
| mL | Milliliter |
| L | Liter |
| μg | Microgram |
| mg/L | Milligram per liter |
| ppm | Parts per million |
| ppb | Parts per billion |
| μm | Micron |
| μmol | Micromole |
| μmol/L | Micromole per liter |
| pCi/L | Picocuries per liter |
| mEq/kg | Milliequivalents per kilogram |
| kJ mol^{-1} | Kilojoules per mole |
| $\text{J } ^\circ\text{K}^{-1}\text{mol}^{-1}$ | joules per degree Kelvin per mole |
| $\text{kJ cell}^{-1} \text{ s}^{-1}$ | kilojoules per cell per second |
| U/μL | Enzyme unit per microliter |

ACKNOWLEDGMENTS

First and foremost, I thank my advisor, Dr. Timothy Grundl, for challenging me and helping me build a strong knowledge base and set of skills professionally and academically. I also thank him for his enthusiasm, humor, and unwavering project commitment and support. I owe my success to him. I thank Patrick Anderson for his mentoring and assistance on water analyses and data interpretation at the School of Freshwater Sciences. I thank Ryan Newton and Natalie Gayner for their commitment and support to the microbial portion of this study. I thank my family and friends who tolerated my busy schedule and made the journey interesting and enjoyable. Lastly, I am forever grateful for the love and support from my partner, Zachary M. Richmond.

Chapter 1: Introduction

Groundwater is a significant source of drinking water in Wisconsin. Many communities in eastern Wisconsin rely on the deep aquifer, and the demand for water over time has made aquifer depletion a critical issue. Along with decreasing water levels, the deep aquifer also contains radium concentrations that exceed federal regulations. Shallow groundwater wells have been placed close to the Fox River to mitigate the issues described above. These wells are termed riverbank inducement (RBI) wells.

RBI wells create a more sustainable water supply because RBI wells induce water to flow from the river to the aquifer. The aquifer's recharge is augmented, and it lessens the extent of drawdown. The shallow groundwater also does not contain dissolved radium like the deep aquifer. In addition, water is recycled locally when RBI wells are located downstream of wastewater treatment plants (WWTP). The treated water being discharged from the WWTP originated from the RBI wells, and some of it will be pulled back toward the same RBI wells once it travels downstream, which increases sustainability. However, the close interaction between groundwater and surface water bodies has potential negative effects on the previously pristine aquifer.

An existing monitoring network is located in southeastern Wisconsin. The monitoring network has been studied long-term and an extensive geochemical database has been created and maintained since 2005. The primary study area in the monitoring network is a RBI well field located in the city of Waukesha, Wisconsin. Two RBI wells are located within 200 feet of the river and pump a mixture of groundwater and river water that contains effluent from three upstream WWTPs. A third well is located roughly 1500 feet from the river and pumps pristine groundwater. The Wisconsin Department of

Natural Resources (WDNR) unique well numbers for the RBI wells are RL255 and RL256, and the unique well number for the pristine well is WK947; the common names for the wells are Well 11, Well 12, and Well 13, respectively.

The previously pristine aquifer is now being impacted through the mixing of previously pristine groundwater with river water due to the RBI wells. Microorganisms are native to deep subsurface ecosystems, and it is known that they drive most geochemical reactions within aquifers. This study investigates if, and to what extent, the microbial community present in the shallow groundwater of southeastern Wisconsin is affected by the influx of treated municipal wastewater effluent. The information collected in this study will combine geochemical and microbial community data in groundwater and shed light on how microbial communities behave in impacted aquifers.

1.1 History of the City of Waukesha

Many communities in southeastern Wisconsin and northeastern Illinois tap into the deep sandstone aquifer. Because of the many communities relying on the aquifer, and slow recharge rates in certain areas, long-term data shows that the aquifer is being depleted. In Waukesha County, a thick shale layer limits recharge from getting into the aquifer, and by the mid-2000s groundwater heads in Waukesha had dropped by 450 feet (Gaumnitz et al., 2004). By 2006, the deepest cone of depression in the region lay under the city of Waukesha, Wisconsin (Cape and Grundl, 2006).

Furthermore, many communities relying on the deep aquifer must treat the water due to radium concentrations exceeding federal regulations. The U.S. Environmental Protection Agency (EPA) has set a limit of 5 picocuries per liter (pCi/L) and in 2006, radium concentrations three times the EPA limit were reported in 42 communities that

use the deep aquifer (McCoy, 2016). Because of aquifer depletion and radium contamination, Waukesha city officials decided the deep aquifer was no longer a sustainable resource. Waukesha applied for a diversion under the Great Lakes Compact to switch their water supply from the deep aquifer to Lake Michigan. The diversion was approved in June 2016, and it is expected that Waukesha will change its water supply within the next few years.

In the meantime, the city is utilizing the shallow groundwater wells, or RBI wells, to mitigate aquifer depletion and radium contamination. The RBI wells in Waukesha are located close to the Fox River to augment aquifer recharge by inducing water to flow from the river to the aquifer and lessen drawdown. Furthermore, radium contamination is being addressed through the mixing of radium-free shallow groundwater with radium-tainted water from the deep aquifer. Waukesha Water Utility is also removing radium by hydrous manganese oxide treatment (Waukesha Water Utility, 2014).

Chapter 2: Setting

2.1 Study Area

The Fox River watershed is expansive; the watershed spans southeastern Wisconsin and northeastern Illinois totaling 2,658 square miles (Figure 1). The headwaters of the Fox River watershed are in Colgate, Wisconsin, near Waukesha, and its confluence with the Illinois River is located in Ottawa, Illinois. The Fox River itself is 223 miles long and 32 WWTPs discharge into the river. The portion of the watershed residing in Wisconsin is termed the Upper Fox River watershed and accounts for 938 square miles of the total area.

The topography of the main study in Waukesha, Wisconsin is primarily composed of glacial features. The Wisconsin Glaciation is the most recent period of the Ice Age, which ended approximately 10,000 years ago. Near the end of the Wisconsin Glaciation, glacial till and glacial outwash sediments were deposited and various glacial features such as moraines, drumlins, kames, and outwash plains characterize the period. A series of ridges were formed in what is known today as southeastern Wisconsin from two ice lobes, and today the ridges create a gently rolling landscape. Depressions formed by large chunks of melting ice are also located among the ridges. In Waukesha County, elevation ranges from 700 to 900 feet above mean sea level.

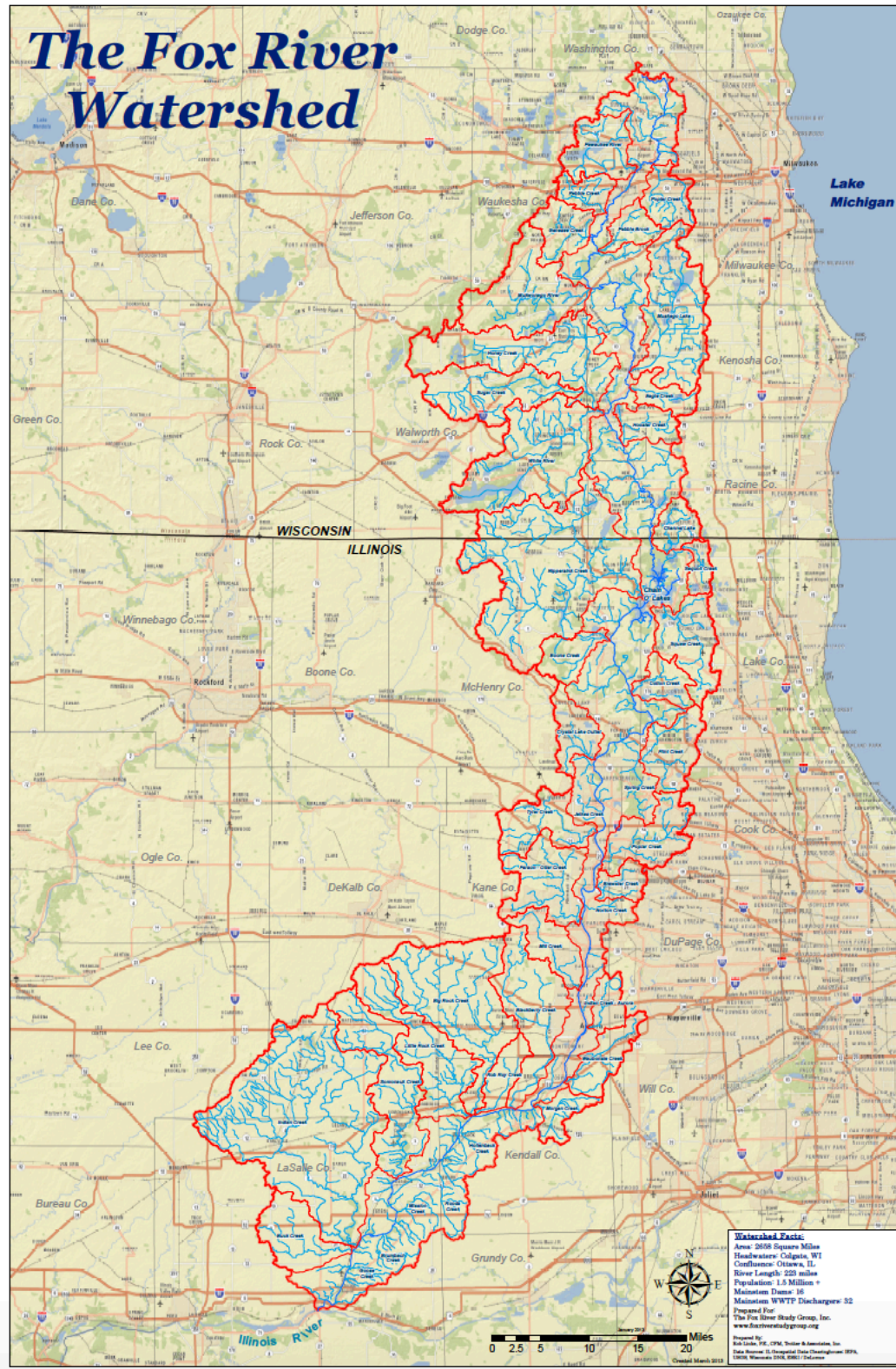

Figure 1. Map of the Fox River Watershed (Fox River Study Group, Inc. 2018).

2.2 Climate and Precipitation

The National Oceanic and Atmospheric Administration National Climatic Data Center reports an average annual temperature of 6.94°Celsius and an average annual precipitation of 0.84 meters for Waukesha WI Station USC00478937 between 2002 and 2013. Most of the precipitation occurs in the summer and the least amount of precipitation occurs in the winter.

2.3 Regional Geology

Waukesha County is situated east of the Wisconsin Arch in the Michigan Basin. Preglacial and glacial erosion shaped bedrock topography in the County. Bedrock dips eastward at a rate of approximately 10 feet per mile. From bottom to top, the bedrock units generally consist of Precambrian igneous and metamorphic rocks; Cambrian sandstone, Ordovician dolomite, sandstone, and shale; and Silurian dolomite (WaukeshaCounty.gov). Throughout most of the County, the uppermost bedrock unit is composed of Silurian deposits that overlays an impervious layer of Maquoketa shale.

2.4 Hydrostratigraphy

The hydrostratigraphy of the Waukesha County consists of several units that influence flow and chemical dynamics of groundwater in southeastern Wisconsin. Regional hydrostratigraphy is shown in Figure 2 and the following information is based on Klump et al. (2008). The deep aquifer is composed of Cambrian and Ordovician deposits underlying the Sinnippee Group and Maquoketa Formation. The Cambrian and Ordovician deposits form the Cambrian-Ordovician Aquifer System and it underlies the Maquoketa Aquitard. The units act together as a regional confining aquitard and that has vertical hydraulic conductivities 1.5×10^{-6} m/d. A shallow, unconfined aquifer overlay the

regional aquitard and it is composed of dolomite from the Silurian and Devonian Periods with a layer of glacial deposits from the Pleistocene Era. These units form the Quaternary and Silurian Aquifers. All the bedrock units thicken and dip eastward, and confined conditions are present in the deep aquifer creating lateral groundwater flow toward Lake Michigan. The Maquoketa Aquitard thins westward where its confining capability diminishes. West of the Maquoketa Formation boundary, the Sinnippee Group no longer acts as an aquitard because the bedrock unit has been highly weathered. Because of this, the shallow sandstone aquifer and the deep aquifer are hydraulically connected, and recharge occurs exclusively in this area (Figure 3).

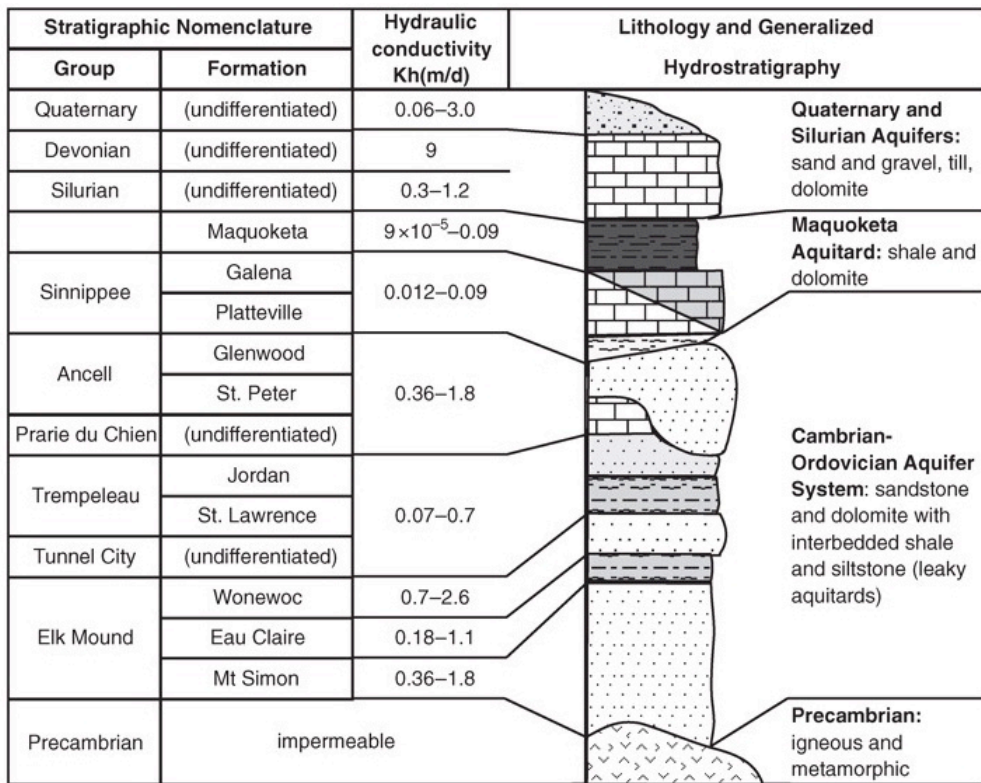

Figure 2. Generalized hydrostratigraphic column for southeast Wisconsin (Klump et al., 2008).

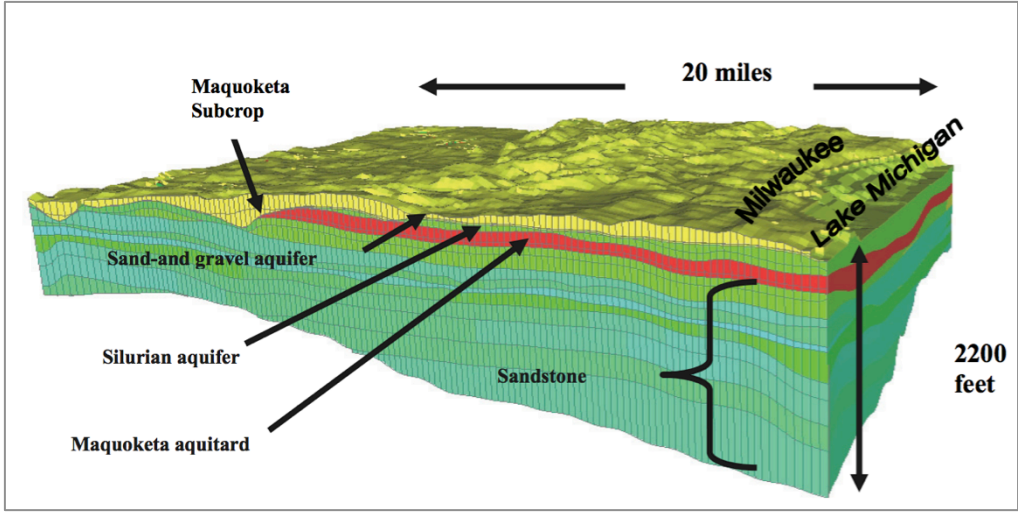

Figure 3. Cross section showing general hydrogeology of southeast Wisconsin (WaukeshaCounty.gov).

Chapter 3: Study Parameters

Physical parameters included alkalinity, pH, specific conductivity, and temperature. Geochemical parameters included dissolved gases, dissolved organic carbon (DOC), major ions, and nutrients. Microbial parameters included 16S rRNA gene community composition, 16S rRNA activity, and metagenomic sequencing. Ribosomal RNA (rRNA) mediates protein synthesis as part of the ribosome. Throughout evolutionary history, rRNA has remained highly conserved and it is found in all known living organisms. In microorganisms, there are variable regions specific to different taxa within the conserved regions of the rRNA gene, making it a good molecular marker to target and identify phylogeny and taxonomy. The hypervariable v4 region was targeted in this study to capture both archaeal and bacterial microorganisms (Parada, Needham, and Fuhrman, 2016; Walters et al., 2016). Microbial community composition data indicated which microorganisms were present in the shallow groundwater wells and in what abundance. The data essentially indicates “who” was there, “who” contributed to the activity of the system, and how environmental conditions impacted community structure. Community compositions were determined using microbial 16S rRNA gene sequencing. 16S rRNA activity data indicated “who” was active and in what ratio to 16S genetic abundance, while metagenomic sequencing indicated the genetic potential.

Chapter 4: Previous Research

4.1 Previous Fox River Studies

Previous studies have been conducted on the monitoring network used in this study, and geochemistry data has been collected at each site in the monitoring network for over a decade. Thorp (2013) used the monitoring network to investigate the occurrence of Fox River water entering Well 11 and Well 12 through geochemical analysis, quantified the extent of anthropogenic influence on the aquifer using geochemical modeling, and discriminated between sources of contamination using trace element and stable isotope analysis. Most recently, Fields-Sommers (2015) used the monitoring network to define recharge mechanisms of induced water from the Fox River coming into the RBI wells through hydrogen and oxygen isotopes, as well as geochemical tracers to locate the source of salt influx in the RBI wells, she also continued the overall geochemistry tracking of the monitoring network to maintain a long-term database.

Thorp (2013) predicted major ions would level off after an initial breakthrough; however, major ion analysis from Fields-Sommers (2015) showed that sodium and chloride levels in both RBI wells continued rising (Figures 4 and 5). A stepwise increase was especially visible in Well 11. Feinstein et al. (2010) successfully predicted the first rise would occur with an increase in pumpage, because of more water being induced to flow towards the RBI wells. Approximately four years after the RBI wells became operational, the pumpage dropped and the first plateau occurred. A second rise occurred as pumpage increased again, approximately six to ten years after the RBI wells became operational. The sodium and chloride concentrations leveled off in a second plateau in

early 2014 due to a decrease in pumpage. The overall trend of sodium and chloride in both RBI wells is influenced heavily by the amount of pumpage, indicating anthropogenic activities in the form of WWTP effluent are affecting the wells.

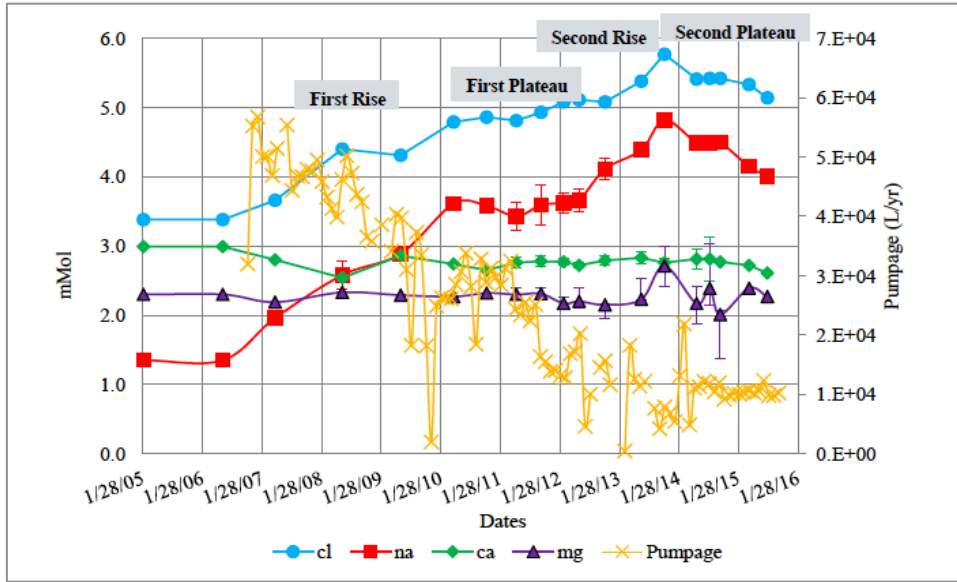

Figure 4. Major ion chemistry in Well 11 from 2005 through 2015 (Fields-Sommers, 2015).

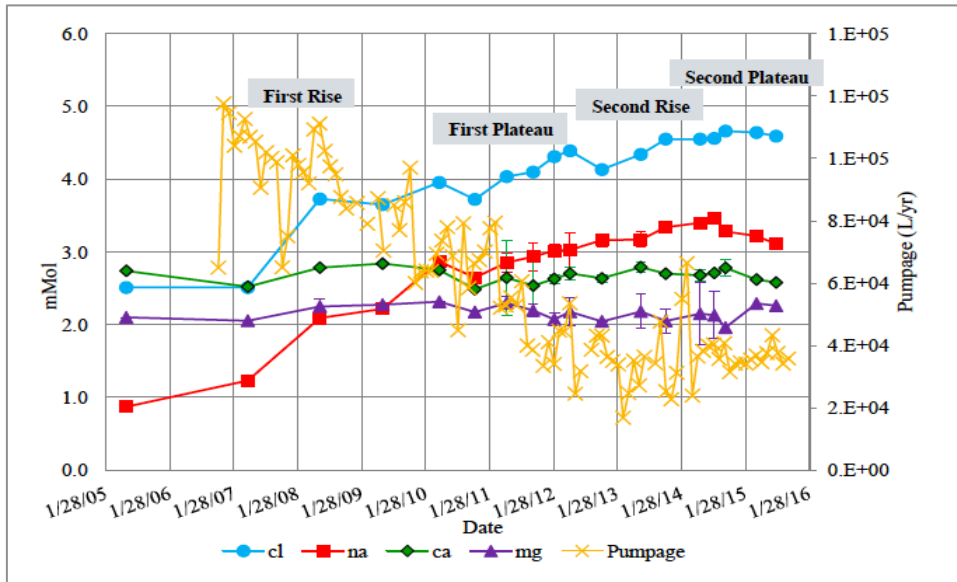

Figure 5. Major ion chemistry in Well 12 from 2005 through 2015 (fields-Sommers, 2015).

Unlike both RBI wells, the major ion chemistry of the pristine well remained constant over time regardless of the amount of pumpage (Figure 6). Sodium concentrations ranged

from 2.1-2.5 mMol/L while chloride concentrations ranged from 1.5-1.7 mMol/L throughout the wells operational period, 2010 through 2016. The current study extends the data from 2016 through 2018. The major ion results from Well 13 show the well has no hydrologic connection to the Fox River, and only pumps pristine groundwater.

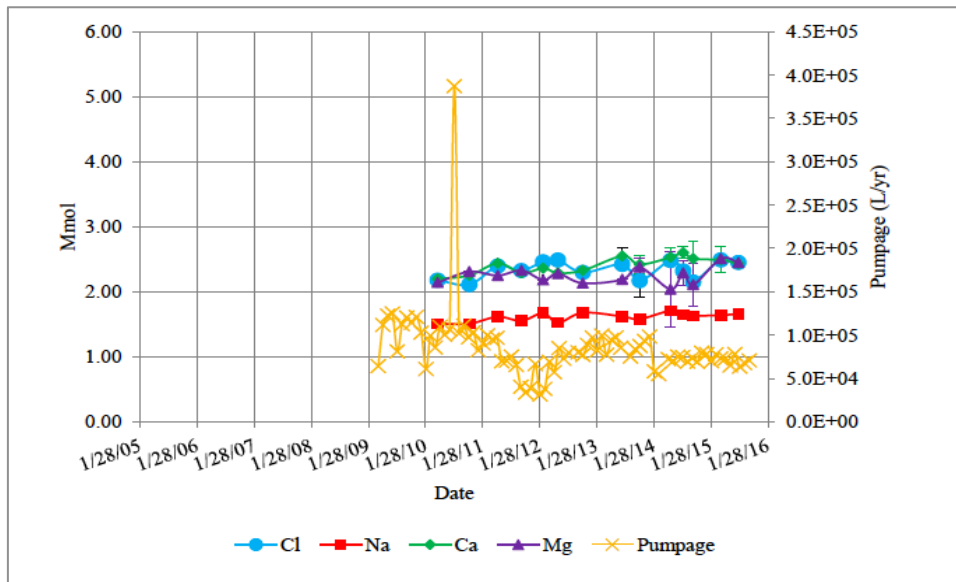

Figure 6. Major ion chemistry in Well 13 from 2009 through 2015 (Fields-Sommers, 2015).

Thorp (2013) discriminated between the sources of contamination entering the RBI wells. The Fox River water entering the wellfield is enriched in sodium chloride. Natural and anthropogenic sources of salt, such as seawater and WWTP effluent can be distinguished through the boron/chloride ratio (Vengosh et al., 13 1991). Figure 7 shows the comparison between end member waters to a mixing line of pristine well water to seawater. The red is composed of three end member waters. The yellow square point is an average of 50 WWTP samples, the green circle point is an average of Fox River water, and the red circle point is pristine well water. The blue line represents a mixing line of pristine well water and seawater. The red square points and the yellow triangle points

represent the RBI wells. The RBI wells plot against the end member line, indicating that the salt in the water of the RBI wells is WWTP effluent dominated.

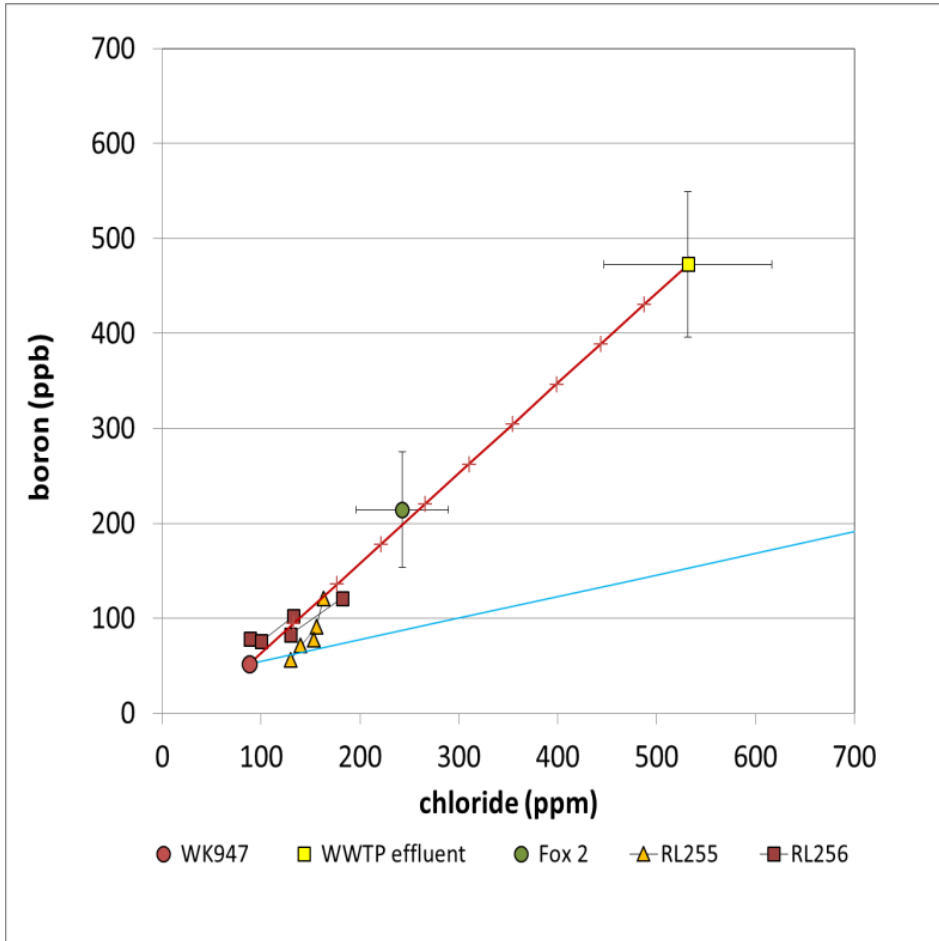

Figure 7. RBI wells pumping a mix of pristine groundwater and WWTP effluent (Thorp, 2013).

4.2 Previous Microbiology Studies

Geochemistry data collected from the monitoring network was combined with microbial community data sets to identify thermodynamically feasible metabolic pathways capable of being carried out by the microbial consortia. As the microbiology field has grown, the number of metagenomic data sets that represent sequences from a wide range of microbial communities has increased (Delmont et al., 2012). The data identified potential metabolic pathways and geochemical reactions being carried out by

the microbial consortia. Previous studies have successfully used metagenomics to study the functional capabilities of microorganisms in aquifers (Lisle, 2014). For example, Smith et al. (2012) examined the extent of variation between the composition and function of microbial communities in two aquifer systems. Lin et al. (2012) and Luef et al. (2015) also completed studies using metagenomics to study groundwater. Amend and Shock (2012) formulated 370 possible reactions that are related to microbial metabolism in environmental systems. Lisle (2014) looked at the 370 possible reactions laid out by Amend and Shock (2012) and identified five energetically favorable reactions in the Floridian aquifer system located in southern Florida. Lisle determined which biogeochemical reactions were favored in the Floridian aquifer from thermodynamic principles to calculate free energy yields. The biogeochemical reactions most likely to proceed were determined by calculating the Gibbs free energy for each specific well in the study. The free energy yields of redox reactions driven by microbial activity were applied to constrain the list of the possible biogeochemical reactions to those that were relevant to the study environment. A similar approach was used to combine the geochemical and metagenomic data in this study. This study used similar techniques, but it differed from the previously mentioned studies by comparing microbial communities from pristine and impacted wells.

Previously unknown microorganisms were discovered in groundwater recently, which expanded the tree of life (Hug et al., 2016). Many of the previously unknown organisms were discovered using 16S rRNA gene sequencing and genome sequences deriving from the anoxic subsurface. The recently discovered microorganisms largely make up the Diapherotrites, Parvarchaeota, Aenigmarchaeota, Nanoarchaeota,

Nanohaloarchaea (DPANN) phylum and candidate phyla radiation (CPR) in the new tree of life (Castelle et al., 2015b; Eme and Ford Doolittle, 2015; Hug et al., 2016; Liu et al., 2018; Rinke et al., 2013). The Banfield Lab at University of California, Berkeley, found the recently discovered radiations. Jill Banfield has pioneered the groundwater microbial field and the newly discovered radiations expanded the tree of life (especially bacteria) by approximately 40% in the last few years and the sequences and organisms originated from groundwater.

Chapter 5: Relevance and Research Objective

RBI wells in southeastern Wisconsin are pumping 40-60% Fox River water that contains significant amounts of WWTP effluent. There is a need to understand how shallow groundwater aquifers are being impacted by anthropogenic activities. Shallow aquifers are important sources of water for municipal uses like drinking water, agriculture, and industry. Microorganisms are also known to be key players in biogeochemical reactions that influence water quality and treatment processes. The purpose of the proposed research is to investigate if, and to what extent the microbial community present in the shallow groundwater of southeastern Wisconsin is affected by the influx of treated municipal wastewater effluent. This study combined two graduate students' research by merging geochemical analysis and microbial analyses to obtain a more complete picture of a valuable freshwater resource. The change in microbial community composition and genetic functional potential between pristine and impacted groundwater sites will be characterized to better understand the impact of anthropogenic activities on native microbial communities. The specific objective of this study is outlined below:

1. Define differences in the microbial communities and the functional reactivity between pristine and contaminated portions of a shallow sand and gravel aquifer.
 - i. Collect groundwater samples from a shallow sand and gravel aquifer and analyze them for microbial community genetic/physiological potential and composition. Samples will be collected from a pristine portion of the aquifer and a portion impacted with treated WWTP effluent.

- ii. Collect geochemical data on the same samples and calculate free energy yields to determine energetically favorable reactions present in the system.
- iii. Assess differences in the microbial communities and geochemical reactivities of the pristine and contaminated locations.

Chapter 6: Methods

6.1 Monitoring Network

This study was conducted in southeastern Wisconsin on an existing monitoring network consisting of 18 sites. The sites are in the Root, Menomonee, and Fox River watersheds in Waukesha and Milwaukee County, Wisconsin. The monitoring network is composed of seven high capacity wells, seven river locations, one artesian spring, and three WWTPs. Three high capacity wells are operated by the City of Brookfield (IZ385, IZ386, and EM275) and one high capacity well (SV631) is in St. Martin's of Tours Parish in Franklin, Wisconsin. Four river sites are located on the Fox River (Fox 0-3), and the three remaining river sites are located on the Root River, Sussex Creek, and Underwood Creek. Hygeia Spring, the artesian spring, is in Big Bend, Wisconsin. The three WWTPs are in Brookfield, Sussex, and Waukesha, Wisconsin. The primary study area is in a well field near the upper Fox River in Waukesha, Wisconsin. The City of Waukesha operates three high capacity wells in the shallow sand and gravel aquifer. Two RBI wells, Well 11 and Well 12, are located 225 feet and 83 feet, respectively, from the riverbank. The background well, Well 13, is located 1,500 feet from the riverbank. See Figure 8 for detailed locations. The two RBI wells are pumping as much as 50% river water, which contains treated wastewater effluent from the three WWTPs, and the background well is pumping pristine groundwater. All three of the wells are screened in a shallow gravel layer at depths ranging from 60 to 150 feet.

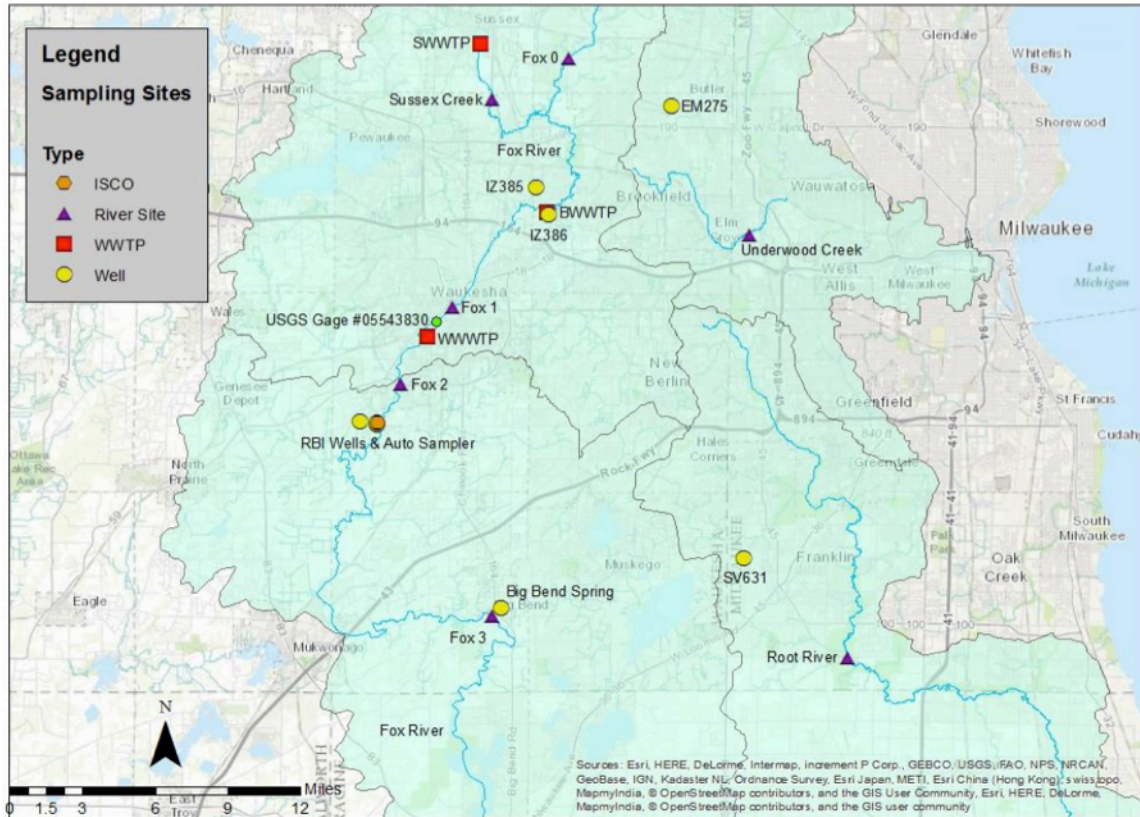

Figure 8. Map of monitoring network, with light green indicating the watersheds of the sampling sites (Fields-Sommers, 2015).

The monitoring network was sampled in the spring, summer, and fall over a 14-month period. Sampling of river sites was conducted during baseflow conditions when the aquifer has the most influence over surface water. Baseflow conditions were determined by USGS stream gage on Fox River at Waukesha, Wisconsin (gage # 05543830). The gaging station is located less than a mile downstream from Fox 1. Water from each site was analyzed for geochemical composition (major ions, nutrients, dissolved gases and DOC), and water from the primary study area was also analyzed for microbial community composition (16S rRNA gene composition, 16S rRNA activity).

6.2 Field Methods and Equipment

At river sites, and the artesian spring, a Teflon bailer was used to collect water at equal intervals across the river. The water was combined to create a representative

sample of the entire site. For well sampling, water was collected using a flow-through chamber that was connected to the well sampling port through tubing. Wells were purged for a minimum of 10 minutes prior to sampling to ensure the sample was representative of native groundwater. At each WWTP a 24-hour composite sample was taken by staff and refrigerated in a 1 liter (L) Nalgene bottle with as little air as possible to reduce oxygen exposure. The WWTP samples were picked up the following day.

Nitrile gloves were used in sample preparation and during sampling. All sample bottles, syringes, and filter holders were washed in an acid bath composed of 90% distilled water and 10% hydrochloric acid for a minimum of 12 hours before use. Sampling equipment was single use and disposed of after use to prevent cross contamination. Tubing used at each well was not replaced, but was thoroughly cleaned while the wells were purged.

Water samples were filtered using 0.2 micron (μm) regenerated cellulose filters. Filtering took place in the field using 60 milliliter (mL) plastic syringes. Two Nalgene 250 mL bottles were filled with filtered water for major ion analysis. The bottle designated for cation analysis received 1 mL of trace metal nitric acid for preservation. At the primary study area, a 250 mL Nalgene bottle was filled with filtered water for nutrient (nitrate, nitrite, ammonium, and phosphate) and DOC analysis. Major ion samples were refrigerated until analysis, while nutrient and DOC samples were frozen.

Hydrogen gas was sampled following microseeps gas stripping cell instructions from Pace Analytical (Appendix A). Groundwater was pumped through a cell at a rate of over 300 mL/minute for 10 minutes. The cell contained air after 10 minutes it was

determined to be at equilibrium. When the equilibrium time was up, 15 mL sample of gas was withdrawn from the cell. The sample was then sent to Pace Analytical for analysis.

The physical parameters (dissolved oxygen, electrical conductivity, and temperature) were measured at each site except the WWTPs. Dissolved oxygen was measured using YSI Model 52 oxygen meter with high sensitivity electrode membrane that was calibrated to the current barometric pressure before sampling, and a CHEMetrics colormetric ampoule kit for low oxygen (K-7501) was used to replicate the dissolved oxygen measurement. Electrical conductivity was measured using a YSI Pro30 Conductivity Meter. Temperature readings were given on each YSI meter. For river sites, the meter probes were placed as far off the riverbank as possible to ensure the most accurate measurement. In the artesian spring, the meters were put directly into the outflow pipe. In the well houses, the meters were situated in the flow-through chamber.

Chemical parameters that are subject to rapid change (alkalinity, ferrous iron, and pH) were measured in the field at each site except the WWTPs. Prior to the summer of 2017, alkalinity was measured by taking a 50 mL water sample and titrating it to 4.5 pH using 0.2 Normal hydrochloric acid. The total acid added was determined by the mass difference between the original 50 mL sample and the mass of the sample post titration, using an Ohaus SP402 portable scale. After the summer of 2017, a Hach digital titrator was used in place of the scale. Alkalinity that could not be measured in the field was estimated by charge balance with the major ions. Ferrous iron was measured using a CHEMetrics colormetric ampoule kit (K-6210). pH was measured using an Accumet 1002 pH meter by Fisher Scientific and calibrated to pH of 4.0 and 7.0.

Microbial RNA and DNA for 16S rRNA gene sequencing were obtained by collecting 2-3 L water samples from each well house in the Waukesha well field. Water was filtered in the field using an in-line filtration system. Water was filtered sequentially through 3 μm , 0.2 μm and 0.1 μm polycarbonate filters with a diameter of 47 mL. Filter papers were stored in sterile 2 mL tubes. To minimize the fast degradation/alteration rate of RNA, tubes were flash frozen by being placed in liquid nitrogen immediately after filtration. One mL of 3 μm filtrate and 0.2 μm filtrate was collected and fixed with formalin for cell enumeration using DAPI fluorescent stain and microscopy. Water samples were stored in an -80°C freezer until extraction processing.

Microbial genomic DNA for shotgun metagenomic sequencing was obtained by collecting 20 L water samples from each well house in the Waukesha well field. Water was filtered sequentially at the School of Freshwater Sciences using an in-line filtration system through 3 μm , 0.2 μm and 0.1 μm polycarbonate filters with a diameter of 142 mL. Filter papers were stored in sterile whirl pak bags in an -80°C freezer until extraction.

6.3 Laboratory Methods

All analyses were conducted at the University of Wisconsin - Milwaukee School of Freshwater Sciences. Major ion samples were analyzed on an ion chromatograph and atomic absorption spectrometer for anions and cations, respectively. Anion analytes, chloride (Cl^-), nitrate (NO_3^-), phosphate (PO_4^-), and sulfate (SO_4^{2-}), were analyzed using ion chromatography on a DIONEX ICS-1000 IC System with Chromeleon version 6.80 SR7 workstation software. Cation analytes, calcium (Ca^{2+}), sodium (Na^+), magnesium (Mg^{2+}), and potassium (K^+), were analyzed using atomic absorption spectroscopy on a

SOLAAR with version 11.02 workstation software. Calibrations were performed at the beginning of each analytical run to account for drift. Ion concentrations were calculated independently of the previously mentioned software using calibration curves constructed from chemical standards (See Appendix B).

Nutrient samples were analyzed on an ion chromatograph, AutoAnalyzer, and spectrophotometer for nitrate (NO_3^-), nitrite (NO_2^-) and ammonium (NH_4^+), and total dissolved phosphorous, respectively. Nutrient samples were analyzed using multiple methods. Nitrate was analyzed on an ion chromatograph following the same methods used to analyze major ions. Nitrogen species, nitrite and ammonium, were measured using the molybdenum blue method on an AutoAnalyzer. Total dissolved phosphorus was measured on a spectrophotometer using the molybdate method after photo-oxidation was used to break down dissolved organic phosphorus compounds into orthophosphate.

DOC was analyzed using the high temperature combustion method by converting inorganic carbon to dissolved carbon dioxide, after which it was purged from the sample. The remaining organic carbon was oxidized to carbon dioxide, which was detected by the instrument and correlated to total organic carbon.

Staff in the Bootsma and Klump lab at the School of Freshwater Sciences analyzed dissolved carbon dioxide and methane, respectively. Pace Analytical analyzed hydrogen gas.

Natalie Gaynor at the School of Freshwater Sciences analyzed microbial data using the following methods. Filter papers were used for DNA and RNA extraction. The 0.2 μm and 0.1 μm pore size filter papers were cut within their collection tubes using sterilized small dissection scissors. DNA and RNA were simultaneously extracted from

the same sample using Qiagen's AllPrep Powerviral DNA/RNA kit. Zirconian beads were added to the sample tubes after cutting the filters into small pieces and vortexed in a bead beater for 2.5 minutes, then the samples were placed on ice for 5 minutes. The process was repeated for a total of 2 bead beating (Smith et al., 2012) steps. The extraction process followed manufacturer's instructions except for elution in three volumes up to 100 microliters (μL). Extracted DNA and RNA were stored in sample tubes and placed in an -80°C freezer.

Promega's RQ1 RNase-Free DNase (Cat #M6101) kit for DNase Treatment of RNA Samples Prior to RT-PCR was used. Promega's DNase protocol called for 1-8 μL of RNA sample in elution buffer. The full 8 μL of sample was used due to the groundwater samples being from low biomass systems with low nucleic acid yields. A total of 16 μL of RNA sample was used per sample per DNase treatment in order to have enough for two reactions (one positive with reverse transcriptase, and one negative without reverse transcriptase) in subsequent steps in the RT-PCR. One μL of DNase (the protocol called for 1 unit or μL per 1 μg of RNA), and 2 μL of Buffer were used in the 16 μL sample reactions.

RNA was reverse transcribed using the Promega's GoScript™ Reverse Transcription System. The reverse primer 806Rb for the v4 16S rRNA gene region was used in the cDNA synthesis (806 μm Rb – GGACTACNVGGGTWTCTAAT). 8.5 μL of DNase treated RNA was used with 1.5 μL of primer for each reaction. Each sample had two reactions: one positive reaction including the reverse transcriptase and one negative reaction without the reverse transcriptase. The two reactions were used to ensure the

DNAase treatment worked correctly and no carryover-over of initial DNA remained in the RNA/cDNA sample for the subsequent 16S rRNA gene PCR.

Polymerase Chain Reaction (PCR) was used to target and amplify the v4 16S rRNA gene region in the DNA and cDNA samples using Invitrogen's™ Platinum™ Taq DNA Polymerase. Forward and reverse primers 515Fb and 806Rb with Illumina adapters were used, as shown below:

515Fb-illumina –

TCGTCGGCAGCGTCAGATGTGTATAAGAGACAGGTGYCAGCMGCCGCGGTAA

806Rb-illumina –

GTCTCGTGGGCTCGGAGATGTGTATAAGAGACAGGGACTACNVGGGTWTCTAAT

Reactions were run in triplicate for each sample and then pooled prior to cleanup with the AMPure Bead cleanup system. One PCR reaction out of the three triplicates for each sample was screened using gel electrophoresis to verify amplification and DNA fragment size. A modified reconditioned/nested PCR protocol was used when one normal PCR (25 μ L reaction volume, 1 μ L template, 30 cycles) was not sufficient for sample amplification. In the reconditioned PCR, two consecutive PCR's were carried out. The first PCR had a smaller reaction volume and shorter cycle period, however, 1 μ L of template was still used (15 μ L reaction volume, 1 μ L template, 10 cycles). Then 1 μ L of the reconditioned PCR was used as a template in the full PCR (25 μ L reaction volume, 1 μ L of template, 30 cycles). Negative control reaction components, volumes, and concentrations are described below.

Table 1. Negative control reaction components, concentrations, and volumes.

| Master Mix of PCR Components | Working Concentration | Normal PCR | Reconditioned PCR |
|-------------------------------------|------------------------------|-------------------|--------------------------|
| Reaction Volume | - | 25 | 15 |
| PCR Cycles | - | 30 | 10 |
| 10x Buffer for Platinum Taq | 10x | 2.5 µL | 1.5 µL |
| F Primer | 5 µm stock | 1 µL | 0.6 µL |
| R Primer | 5 µm stock | 1 µL | 0.6 µL |
| 50 mM MgSO ₄ | 50 µm | 1 µL | 0.6 µL |
| 10 mM dNTP Mix | 10 mm | 0.5 µL | 0.3 µL |
| Platinum Taq Polymerase | 5 U/µL | 0.1 µL | 0.06 µL |

Table 2. PCR thermocycler conditions.

| PCR Thermocycler Conditions | | | |
|--|----------------------|------|------------|
| 1 | Initial denaturation | 94°C | 5 minutes |
| 2 | Denature | 94°C | 30 seconds |
| 3 | Anneal | 50°C | 45 seconds |
| 4 | Extend | 72°C | 60 seconds |
| Repeat 2 – 4 30x, or 10x for first reconditioned PCR step | | | |
| 5 | Final Extension | 72°C | 2 minutes |
| 6 | Hold | 10°C | Hold |

Sequencing was performed on the Illumina MiSeq at the Great Lakes Genomics Center (GLGC). An extraction blank was run as a negative control and a mock community was sequenced as a positive control for quality control and processing. Data was processed in-house through GLGC support (Aurash Mohaimani). Data was further processed through Mothur (Schloss et al., 2009), DADA2 (Callahan et al., 2016), and SILVA classification (Quast et al., 2013). R and RStudio was used to visualize and statistically analyze (Willis, 2017) processed data along with the vegan package in R (Oksanen, 2005; Oksanen et al., 2013).

6.4 Thermodynamic Calculations

Seven groundwater samples were collected from each shallow groundwater well (Well 11, Well 12, Well 13) over a 14-month period spanning from November 2016

through January 2018 and analyzed for common groundwater constituents for biogeochemical analyses. The constituents were averaged between the seven samples to create a composite sample representative of the groundwater in each well (Table 3). Sulfide and ferrous iron were not detected in any shallow groundwater wells, however, Chemet kits were used to perform the measurements, and so the detection limits for the Chemet kits were used in thermodynamic analyses to account for minuscule concentrations of the constituents.

Table 3. Composite water quality data for three shallow groundwater wells with respective standard deviations from November 2016 through January 2018.

| Parameter | Units | RBI | RBI | Pristine |
|----------------------------|--------|--------------|--------------|--------------|
| | | Well 11 | Well 12 | Well 13 |
| Temperature | °C | 10.42 ± 1 | 10.61 ± 0.2 | 10.5 ± 0.1 |
| pH | | 6.98 ± 0.1 | 6.99 ± 0.2 | 7.06 ± 0.6 |
| Calcium | mg/L | 93.12 ± 30 | 90.48 ± 20 | 83.71 ± 10 |
| Chloride | mg/L | 218.48 ± 60 | 201.28 ± 60 | 97.24 ± 30 |
| Magnesium | mg/L | 54.93 ± 2 | 53.32 ± 2 | 56.71 ± 4 |
| Potassium | mg/L | 3.3 ± 0.8 | 3.16 ± 0.5 | 2.56 ± 0.5 |
| Sodium | mg/L | 101.43 ± 5 | 81.1 ± 3 | 39.79 ± 2 |
| Dissolved oxygen | mg/L | 0.18 ± 0.3 | 0.15 ± 0.2 | 0.14 ± 0.2 |
| Ferrous Iron | mg/L | 0.1 | 0.1 | 0.1 |
| Ammonium | mg/L | 0.001 | 0.07 | 0.03 |
| Nitrate | mg/L | 1.49 ± 1 | 0.3 ± 0.7 | 1.74 ± 1 |
| Nitrite | mg/L | 0.05 | 0.003 | 0.04 |
| Sulfate | mg/L | 64.11 ± 20 | 68.17 ± 10 | 96.9 ± 10 |
| Sulfide | mg/L | 0.1 | 0.1 | 0.1 |
| Total dissolved phosphorus | mg/L | 0.002 | 0.004 | 0.003 |
| Dissolved organic carbon | mg/L | 0.49 ± 0.3 | 0.93 ± 0.3 | 0.65 ± 0.4 |
| Bicarbonate | mg/L | 420.68 ± 200 | 462.25 ± 100 | 411.26 ± 100 |
| Hydrogen | μmol/L | 0.002 | 0.005 | 0.004 |
| Methane | μmol/L | 0.007 | 0.417 ± 0.2 | 0.043 |

Free energy calculations were performed with 22 biogeochemical reactions to access the potential metabolic pathways being carried out by the microbial consortia. The reactions include the groundwater constituents measured in this study and are commonly driven by microorganisms in groundwater systems (Davidson et al., 2011; Lisle, 2014) (Table 4).

Table 4. Balanced biogeochemical reactions.

| Reaction Number | Reaction |
|-----------------|---|
| 1 | $\text{CH}_4 + \text{SO}_4^{2-} \rightarrow \text{H}_2\text{O} + \text{HCO}_3^- + \text{HS}^-$ |
| 2 | $\text{Acetate} + \text{NO}_3^- + \text{H}_2\text{O} \rightarrow 2\text{HCO}_3^- + \text{NH}_3$ |
| 3 | $4\text{H}_2 + 1.6\text{NO}_3^- + 1.6\text{H}^+ \rightarrow 0.8\text{N}_2 + 4.8\text{H}_2\text{O}$ |
| 4 | $\text{Acetate} + 1.6\text{NO}_3^- + 0.6\text{H}^+ \rightarrow 2\text{HCO}_3^- + 0.8\text{H}_2\text{O} + 0.8\text{N}_2$ |
| 5 | $4\text{H}_2 + \text{NO}_3^- + \text{H}^+ \rightarrow \text{NH}_3 + 3\text{H}_2\text{O}$ |
| 6 | $\text{Acetate} + \text{SO}_4^{2-} \rightarrow 2\text{HCO}_3^- + \text{HS}^-$ |
| 7 | $4\text{H}_2 + \text{H}^+ + \text{SO}_4^{2-} \rightarrow \text{HS}^- + 4\text{H}_2\text{O}$ |
| 8 | $4\text{Acetate} + 4\text{H}_2\text{O} \rightarrow 4\text{CH}_4 + 4\text{HCO}_3^-$ |
| 9 | $4\text{H}_2 + \text{H}^+ + \text{HCO}_3^- \rightarrow \text{CH}_4 + 3\text{H}_2\text{O}$ |
| 10 | $4\text{H}_2 + \text{H}^+ + 2\text{HCO}_3^- \rightarrow \text{Acetate} + 4\text{H}_2\text{O}$ |
| 11 | $\text{Acetate} + 8\text{Fe}(\text{OH})_3 + 15\text{H}^+ \rightarrow 8\text{Fe}^{2+} + 20\text{H}_2\text{O} + 2\text{HCO}_3^-$ |
| 12 | $\text{HS}^- + 8\text{Fe}(\text{OH})_3 + 15\text{H}^+ \rightarrow \text{SO}_4^{2-} + 8\text{Fe}^{2+} + 20\text{H}_2\text{O}$ |
| 13 | $4\text{H}_2 + 2\text{O}_2 \rightarrow 4\text{H}_2\text{O}$ |
| 14 | $\text{Acetate} + 2\text{O}_2 \rightarrow 2\text{HCO}_3^- + \text{H}^+$ |
| 15 | $\text{CH}_4 + 2\text{O}_2 \rightarrow \text{HCO}_3^- + \text{H}^+ + \text{H}_2\text{O}$ |
| 16 | $\text{HS}^- + 2\text{O}_2 \rightarrow \text{SO}_4^{2-} + \text{H}^+$ |
| 17 | $(\frac{4}{3})\text{NH}_3 + 2\text{O}_2 \rightarrow (\frac{4}{3})\text{NO}_2^- + (\frac{4}{3})\text{H}^+ + (\frac{4}{3})\text{H}_2\text{O}$ |
| 18 | $\text{H}_2\text{S} + 4\text{NO}_3^- \rightarrow \text{SO}_4^{2-} + 4\text{NO}_2^- + 2\text{H}^+$ |
| 19 | $3\text{H}_2\text{S} + 4\text{NO}_2^- + 2\text{H}^+ + 4\text{H}_2\text{O} \rightarrow 3\text{SO}_4^{2-} + 4\text{NH}_4^+$ |
| 20 | $(\frac{4}{3})\text{NH}_4^+ + 2\text{O}_2 \rightarrow (\frac{4}{3})\text{NO}_2^- + (\frac{8}{3})\text{H}^+ + (\frac{4}{3})\text{H}_2\text{O}$ |
| 21 | $4\text{NO}_2^- + 2\text{O}_2 \rightarrow 4\text{NO}_3^-$ |
| 22 | $8\text{Fe}^{2+} + 2\text{O}_2 + 20\text{H}_2\text{O} \rightarrow 8\text{Fe}(\text{OH})_3 + 16\text{H}^+$ |

The activities of each constituent were used in the free energy calculations expressed by:



where A, B represent the activities of the reactants while C, D represent the activities of the products, and a, b, c, d are the stoichiometric constants from the balanced equations respective to the corresponding activities. The activity of each groundwater constituent was calculated using PHREEQC version 3.1.7.9213 (Parkhurst and Appelo, 2005) with the wateqf.dat database derived from WATEQ4F (Ball and Nordstrom, 1991).

The standard Gibbs free energies (ΔG° , joules per mole) were calculated for the balanced reactions using the following equation:

$$\Delta G^\circ = \sum \Delta G_f^\circ(\text{products}) - \Delta G_f^\circ(\text{reactants}) \quad (2)$$

where ΔG_f° (joules per mole) represents the values for the standard free energy of formation of the products and reactants in each reaction. The Amend and Shock (2011) values of ΔG_f° were used to calculate ΔG° .

The equilibrium constant (K_{eq}) for all 22 reactions was calculated using the ΔG° values and solving for K_{eq} :

$$K_{\text{eq}} = e^{-(\Delta G^\circ/RT)} \quad (3)$$

where R is the universal gas constant (8.3145 joules per degree Kelvin per mole ($\text{J } ^\circ\text{K}^{-1}\text{mol}^{-1}$), and T is temperature ($^\circ\text{K}$).

Free energy values under in situ conditions (ΔG_r) were calculated using the ΔG° values for each reaction, groundwater temperatures (Table 3), and activities of the reactants and products (Appendix B), demonstrated by the following equations:

$$\Delta G_r = \Delta G^\circ + RT \ln Q \quad (4)$$

where

$$Q = [\text{C}]^c [\text{D}]^d / [\text{A}]^a [\text{B}]^b \quad (5)$$

Free energy flux (FEF, kilojoules per cell per second) is the amount of energy a microbial cell can potentially generate from performing each reaction assuming that the reaction proceeds until one reactant (the limiting reactant) is fully consumed. The FEF was calculated by the following equation:

$$\text{FEF} = 4\pi * r * D_c * C * \Delta G_r \quad (6)$$

where r (micrometers) is the radius of the microbial cell, D_c (meters squared per second) is the diffusion coefficient of the limiting reactant, C (moles per cubic meter) is the

concentration of the limiting reactant, and ΔG_r (kilojoules per cell per second) is the free energy of reaction under in situ conditions for each reaction.

Free energy calculations were related to the 22 reactions (Table 4) based on the relationship of free energy yields for the production of adenosine triphosphate (ATP) (Schink, 1997; Thauer et al., 1977). Three assumptions were made to relate the free energy calculations to ATP production or microbial activity. The first assumption was conservation of energy occurs during the electron transport process for all reactions. The second assumption was the conversion of energy to ATP proceeds with maximum efficiency, creating a minimum free energy yield for ATP production, which is commonly set at -20 kilojoules per mole (kJ mol^{-1}) of limiting reactant for ΔG_r . The final assumption was the maximum rate that energy could be gained is dependent on diffusion rates (Onstott, 2005), and that deep subsurface microorganisms are immobile. Only reactions whose ΔG_r were less than -20 kJ mol^{-1} were considered to be energetically favorable.

Chapter 7: Results and Discussion

7.1 Geochemical Analyses

For the composited groundwater sample representative of Well 11 the pH was neutral (6.98) and the temperature low (10.42°C). For the composited sample representative of Well 12, the pH was neutral (6.99) and the temperature low (10.61°C). The geochemical results show slightly higher levels of metabolic gases, in particular methane and hydrogen, higher levels of ammonia and total dissolved phosphate, and lower levels of nitrate in RBI wells. For the composited sample representative of pristine groundwater (Well 13), the pH was neutral (7.06), the temperature low (10.5°C), with low levels of metabolic gases, chloride (97.24 mg/L), and sodium (39.79 mg/L), and high sulfate levels (96.9 mg/L) compared to the RBI wells (Well 11 and Well 12).

Piper diagrams were created for each shallow groundwater well (Figures 9-11). The samples plotted on the Piper diagrams were used to create a composite sample representative of the groundwater in each well used in the thermodynamic calculations. The diagrams are a graphical representation of the chemistry for groundwater samples collected at each well. On the diagrams, each dot represents a different sample, and as the color of the dot gets lighter, it indicates a more recent sample. The samples were collected after the previous study by Fields-Sommers (2015).

As shown on the bottom left ternary plot for each diagram, there is generally no change between samples, indicating calcium and magnesium remain steady over time, as reported by Fields-Sommers (2015). The bottom right ternary plots for the RBI wells show a chloride increase over time, as seen in the previous study. In addition,

concentrations are much higher compared to the pristine well. All wells are near calcite saturation ($SI = -0.10 \pm 0.02$).

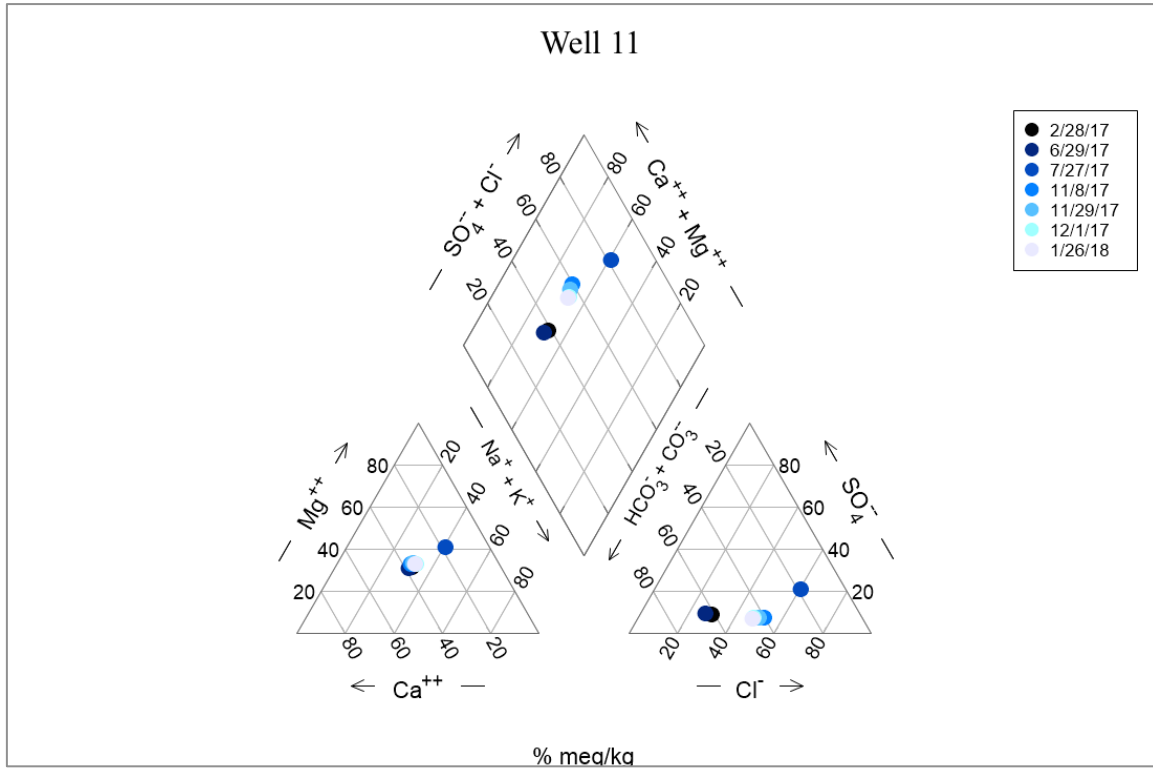

Figure 9. Piper diagram for Well 11.

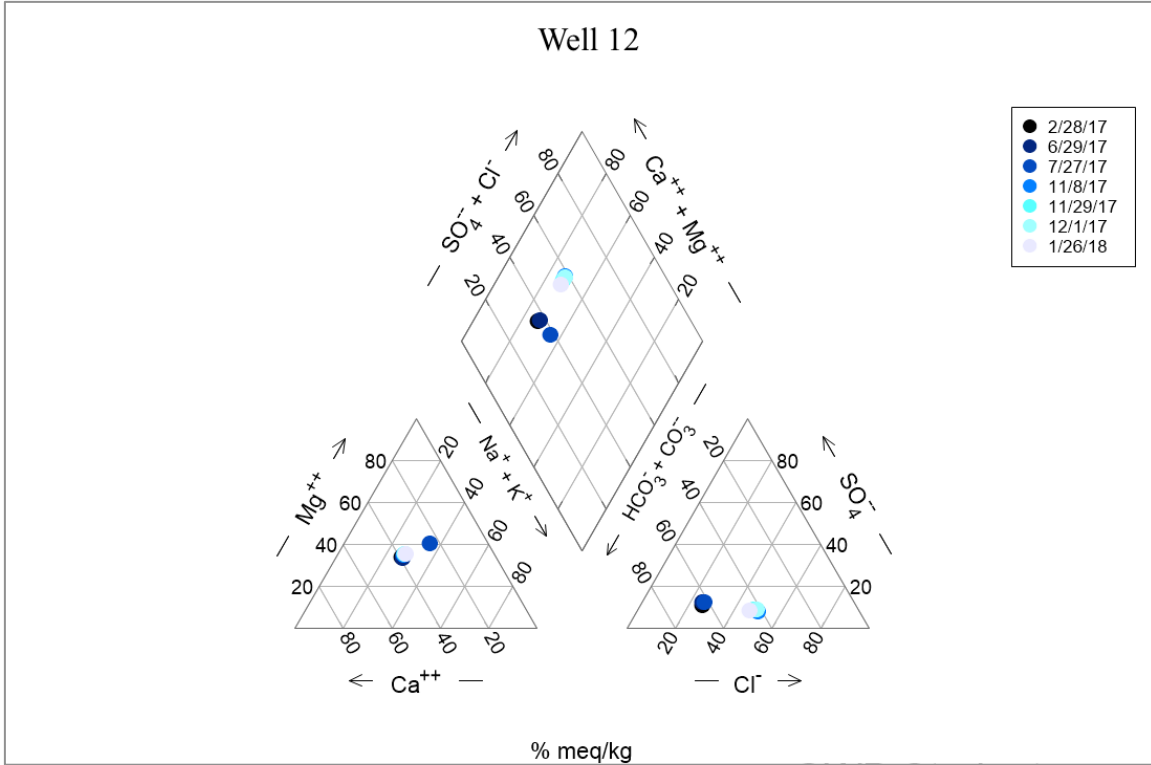

Figure 10. Piper diagram for Well 12.

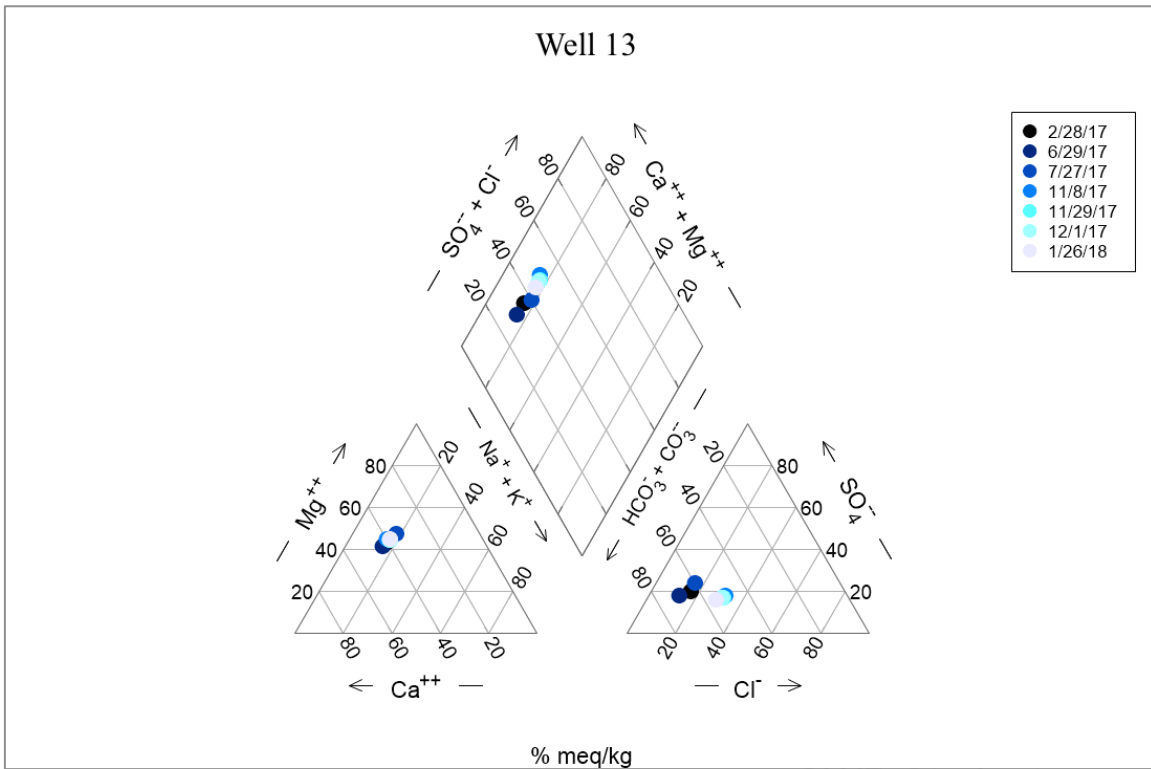

Figure 11. Piper diagram for Well 13.

7.2 Thermodynamic Analyses

The biogeochemical reactions most likely to proceed for each shallow groundwater well were calculated using the geochemistry of the groundwater and thermodynamic analyses. Amend and Shock (2001) formulated 370 possible reactions that are related to microbial metabolism in the environment. Approximately 200 out of the 370 reactions were redox reactions. Free energy yields of the redox reactions were used to constrain the list of most probable biogeochemical reactions. The geochemical data from this study (Table 3) were used to determine which biogeochemical reactions (Table 4) were applicable to the groundwater in this study.

Sulfide and ferrous iron were not detected in any shallow groundwater wells. Chemet kits were used to perform these measurements, therefore, the detection limits for the Chemet kits were used in thermodynamic analyses. The ΔG_r and FEF values are maximum estimates for reactions involving sulfide and ferrous iron. The ΔG_r of all reactions in Table 4 were normalized to 8 moles of electrons transferred per reaction.

Table 5. The free energy of reaction and free energy flux for a set of biogeochemical reactions. [Free energy of the reaction (ΔG_r), kilojoules per mole (kJ mol^{-1}); Free energy flux (FEF), kilojoules per cell per second ($\text{kJ cell}^{-1} \text{s}^{-1}$)]

| Redox Reaction | RBI Well 11 | | RBI Well 12 | | Pristine Well 13 | |
|---|--------------|-------------------------|--------------|-------------------------|-----------------------|------------------------|
| | ΔG_r | FEF | ΔG_r | FEF | ΔG_r | FEF |
| 1. $\text{CH}_4 + \text{SO}_4^{2-} \rightarrow \text{H}_2\text{O} + \text{HCO}_3^- + \text{HS}^-$ | 5 | 2×10^{-19} | -29 | -7.6×10^{-17} | -1 | -1.8×10^{-19} |
| 2. Acetate + $\text{NO}_3^- + \text{H}_2\text{O} \rightarrow 2\text{HCO}_3^- + \text{NH}_3$ | -496 | -2.6×10^{-14} | -498 | -4.9×10^{-14} | -490 | -4.9×10^{-14} |
| 3. $4\text{H}_2 + 1.6\text{NO}_3^- + 1.6\text{H}^+ \rightarrow 0.8\text{N}_2 + 4.8\text{H}_2\text{O}$ | - | - | - | - | - | - |
| 4. Acetate + $1.6\text{NO}_3^- + 0.6\text{H}^+ \rightarrow 2\text{HCO}_3^- + 0.8\text{H}_2\text{O} + 0.8\text{N}_2$ | - | - | - | - | - | - |
| 5. $4\text{H}_2 + \text{NO}_3^- + \text{H}^+ \rightarrow \text{NH}_3 + 3\text{H}_2\text{O}$ | -482 | -3.03×10^{-18} | -477 | -7.53×10^{-18} | 8.09×10^{39} | 91.89 |

| Redox Reaction | RBI Well 11 | | RBI Well 12 | | Pristine Well 13 | |
|---|--------------|------------------------|--------------|------------------------|------------------|------------------------|
| | ΔG_r | FEF | ΔG_r | FEF | ΔG_r | FEF |
| 6. Acetate + $\text{SO}_4^{2-} \rightarrow 2\text{HCO}_3^- + \text{HS}^-$ | -55 | -2.9×10^{-15} | -56 | -5.5×10^{-15} | -57 | -5.7×10^{-15} |
| 7. $4\text{H}_2 + \text{H}^+ + \text{SO}_4^{2-} \rightarrow \text{HS}^- + 4\text{H}_2\text{O}$ | 30 | 1.9×10^{-19} | 21 | 3.3×10^{-19} | 23 | 2.9×10^{-19} |
| 8. $4\text{Acetate} + 4\text{H}_2\text{O} \rightarrow 4\text{CH}_4 + 4\text{HCO}_3^-$ | -237 | -1.3×10^{-14} | -203 | -2.0×10^{-14} | -226 | -2.2×10^{-14} |
| 9. $4\text{H}_2 + \text{H}^+ + \text{HCO}_3^- \rightarrow \text{CH}_4 + 3\text{H}_2\text{O}$ | 25 | 1.6×10^{-19} | 26 | 4.1×10^{-19} | 23 | 2.9×10^{-19} |
| 10. $4\text{H}_2 + \text{H}^+ + 2\text{HCO}_3^- \rightarrow \text{Acetate} + 4\text{H}_2\text{O}$ | 84 | 5.3×10^{-19} | 77 | 1.2×10^{-18} | 80 | 1.0×10^{-18} |
| 11. Acetate + $8\text{Fe}(\text{OH})_3 + 15\text{H}^+ \rightarrow 8\text{Fe}^{2+} + 20\text{H}_2\text{O} + 2\text{HCO}_3^-$ | -409 | -3.0×10^{-16} | -957 | -6.9×10^{-16} | -413 | -2.5×10^{-16} |
| 12. $\text{HS}^- + 8\text{Fe}(\text{OH})_3 + 15\text{H}^+ \rightarrow \text{SO}_4^{2-} + 8\text{Fe}^{2+} + 20\text{H}_2\text{O}$ | -354 | -2.6×10^{-16} | -363 | -2.6×10^{-16} | -356 | -2.2×10^{-16} |
| 13. $4\text{H}_2 + 2\text{O}_2 \rightarrow 4\text{H}_2\text{O}$ | -740 | -4.7×10^{-18} | -704 | -1.1×10^{-17} | -702 | -8.8×10^{-18} |
| 14. Acetate + $2\text{O}_2 \rightarrow 2\text{HCO}_3^- + \text{H}^+$ | -781 | -2.8×10^{-14} | -781 | -2.3×10^{-14} | -782 | -2.2×10^{-14} |
| 15. $\text{CH}_4 + 2\text{O}_2 \rightarrow \text{HCO}_3^- + \text{H}^+ + \text{H}_2\text{O}$ | -722 | -3.2×10^{-17} | -730 | -1.9×10^{-15} | -725 | -2.0×10^{-16} |
| 16. $\text{HS}^- + 2\text{O}_2 \rightarrow \text{SO}_4^{2-} + \text{H}^+$ | -726 | -6.1×10^{-15} | -725 | -6.2×10^{-15} | -725 | -6.7×10^{-15} |
| 17. $(\frac{4}{3})\text{NH}_3 + 2\text{O}_2 \rightarrow (\frac{4}{3})\text{NO}_2^- + (\frac{4}{3})\text{H}^+ + (\frac{4}{3})\text{H}_2\text{O}$ | -341 | -2.5×10^{-19} | -370 | -1.9×10^{-17} | -360 | -9.5×10^{-18} |
| 18. $\text{H}_2\text{S} + 4\text{NO}_3^- \rightarrow \text{SO}_4^{2-} + 4\text{NO}_2^- + 2\text{H}^+$ | -471 | -5.2×10^{-15} | -504 | -5.5×10^{-15} | -496 | -5.0×10^{-15} |
| 19. $3\text{H}_2\text{S} + 4\text{NO}_2^- + 2\text{H}^+ + 4\text{H}_2\text{O} \rightarrow 3\text{SO}_4^{2-} + 4\text{NH}_4^+$ | -1340 | -9.9×10^{-16} | -1251 | -9×10^{-16} | -1280 | -7.8×10^{-16} |
| 20. $(\frac{4}{3})\text{NH}_4^+ + 2\text{O}_2 \rightarrow (\frac{4}{3})\text{NO}_2^- + (\frac{8}{3})\text{H}^+ + (\frac{4}{3})\text{H}_2\text{O}$ | -226 | -1.0×10^{-16} | -251 | -7.8×10^{-15} | -241 | -3.2×10^{-15} |
| 21. $4\text{NO}_2^- + 2\text{O}_2 \rightarrow 4\text{NO}_3^-$ | -248 | -5.6×10^{-15} | -213 | -2.9×10^{-16} | -221 | -4.0×10^{-15} |
| 22. $8\text{Fe}^{2+} + 2\text{O}_2 + 20\text{H}_2\text{O} \rightarrow 8\text{Fe}(\text{OH})_3 + 16\text{H}^+$ | -372 | -2.7×10^{-15} | -362 | -2.5×10^{-15} | -369 | -2.6×10^{-15} |

The ΔG_r and FEF values for heterotrophic reactions (Reactions 1, 2, 4, 6, 11, 14, and 15 in Table 5) in all shallow groundwater wells ranged from -957 to 5 kJ mol^{-1} and -1.8×10^{-19} to $2 \times 10^{-19} \text{ kJ cell}^{-1} \text{ s}^{-1}$, respectively.

Autotrophic nitrate reducing reactions yielded ΔG_r and FEF values ranging from -2288 to -396 kJ mol⁻¹ and -6.2×10^{-18} and -1.4×10^{-15} kJ cell⁻¹ s⁻¹, respectively (Reactions 3, 5, and 19 in Table 5).

The autotrophic iron reducing reaction (Reaction 12 in Table 5) yielded ΔG_r and FEF values ranging from -363 to -354 kJ mol⁻¹ and -2.6×10^{-16} to -2.2×10^{-16} kJ cell⁻¹ s⁻¹, respectively, while the autotrophic sulfate reducing reaction (Reaction 7 in Table 5) yielded values ranging from 21 to 30 kJ mol⁻¹ and 1.9×10^{-19} to 3.3×10^{-16} kJ cell⁻¹ s⁻¹, respectively.

Methanogenesis from hydrogen and carbon dioxide (Reaction 9 in Table 5) yielded ΔG_r and FEF values ranging from 23 to 25 kJ mol⁻¹ and 1.6×10^{-19} to 4.1×10^{-19} kJ cell⁻¹ s⁻¹, respectively, while acetogenesis from hydrogen and carbon dioxide (Reaction 10 in Table 5) yielded values ranging from 77 to 84 kJ mol⁻¹ and 5.3×10^{-19} to 1.2×10^{-18} kJ cell⁻¹ s⁻¹, respectively.

The hydrogen oxidation reaction (Reaction 13 in Table 5) yielded ΔG_r and FEF values ranging from -740 to -702 kJ mol⁻¹ and -8.8×10^{-18} to -1.1×10^{-17} kJ cell⁻¹ s⁻¹, respectively, while fermentation (Reaction 8 in Table 5) yielded values ranging from -237 to -203 kJ mol⁻¹ and -2.2×10^{-14} to -1.3×10^{-14} kJ cell⁻¹ s⁻¹, respectively.

Of the 22 biogeochemical reactions applicable to this study, 16 reactions were determined to be thermodynamically feasible in the shallow groundwater wells, using the minimum free energy yield of -20 kJ mol⁻¹ (Table 6). The FEF values for the energetically favorable reactions range from -2.4×10^{-19} to -1.3×10^{-14} kJ cell⁻¹ s⁻¹ (Table 5).

Table 6. The free energy of reaction and free energy flux for energetically favorable biogeochemical reactions. [Free energy of the reaction (ΔG_r), kilojoules per mole (kJ mol^{-1}); Free energy flux (FEF), kilojoules per cell per second ($\text{kJ cell}^{-1} \text{s}^{-1}$)]

| Redox Reaction | RBI Well 11 | | RBI Well 12 | | Pristine Well 13 | |
|---|--------------|-------------------------|--------------|-------------------------|------------------|------------------------|
| | ΔG_r | FEF | ΔG_r | FEF | ΔG_r | FEF |
| 2. Acetate + $\text{NO}_3^- + \text{H}_2\text{O} \rightarrow 2\text{HCO}_3^- + \text{NH}_3$ | -496 | -2.6×10^{-14} | -498 | -4.9×10^{-14} | -490 | -4.9×10^{-14} |
| 5. $4\text{H}_2 + \text{NO}_3^- + \text{H}^+ \rightarrow \text{NH}_3 + 3\text{H}_2\text{O}$ | -482 | -3.03×10^{-18} | -477 | -7.53×10^{-18} | | |
| 6. Acetate + $\text{SO}_4^{2-} \rightarrow 2\text{HCO}_3^- + \text{HS}^-$ | -55 | -2.9×10^{-15} | -56 | -5.5×10^{-15} | -57 | -5.7×10^{-15} |
| 8. $4\text{Acetate} + 4\text{H}_2\text{O} \rightarrow 4\text{CH}_4 + 4\text{HCO}_3^-$ | -237 | -1.3×10^{-14} | -203 | -2.0×10^{-14} | -226 | -2.2×10^{-14} |
| 11. Acetate + $8\text{Fe}(\text{OH})_3 + 15\text{H}^+ \rightarrow 8\text{Fe}^{2+} + 20\text{H}_2\text{O} + 2\text{HCO}_3^-$ | -409 | -3.0×10^{-16} | -957 | -6.9×10^{-16} | -413 | -2.5×10^{-16} |
| 12. $\text{HS}^- + 8\text{Fe}(\text{OH})_3 + 15\text{H}^+ \rightarrow \text{SO}_4^{2-} + 8\text{Fe}^{2+} + 20\text{H}_2\text{O}$ | -354 | -2.6×10^{-16} | -363 | -2.6×10^{-16} | -356 | -2.2×10^{-16} |
| 13. $4\text{H}_2 + 2\text{O}_2 \rightarrow 4\text{H}_2\text{O}$ | -740 | -4.7×10^{-18} | -704 | -1.1×10^{-17} | -702 | -8.8×10^{-18} |
| 14. Acetate + $2\text{O}_2 \rightarrow 2\text{HCO}_3^- + \text{H}^+$ | -781 | -2.8×10^{-14} | -781 | -2.3×10^{-14} | -782 | -2.2×10^{-14} |
| 15. $\text{CH}_4 + 2\text{O}_2 \rightarrow \text{HCO}_3^- + \text{H}^+ + \text{H}_2\text{O}$ | -722 | -3.2×10^{-17} | -730 | -1.9×10^{-15} | -725 | -2.0×10^{-16} |
| 16. $\text{HS}^- + 2\text{O}_2 \rightarrow \text{SO}_4^{2-} + \text{H}^+$ | -726 | -6.1×10^{-15} | -725 | -6.2×10^{-15} | -725 | -6.7×10^{-15} |
| 17. $(\frac{4}{3})\text{NH}_3 + 2\text{O}_2 \rightarrow (\frac{4}{3})\text{NO}_2^- + (\frac{4}{3})\text{H}^+ + (\frac{4}{3})\text{H}_2\text{O}$ | -341 | -2.5×10^{-19} | -370 | -1.9×10^{-17} | -360 | -9.5×10^{-18} |
| 18. $\text{H}_2\text{S} + 4\text{NO}_3^- \rightarrow \text{SO}_4^{2-} + 4\text{NO}_2^- + 2\text{H}^+$ | -471 | -5.2×10^{-15} | -504 | -5.5×10^{-15} | -496 | -5.0×10^{-15} |
| 19. $3\text{H}_2\text{S} + 4\text{NO}_2^- + 2\text{H}^+ + 4\text{H}_2\text{O} \rightarrow 3\text{SO}_4^{2-} + 4\text{NH}_4^+$ | -1340 | -9.9×10^{-16} | -1251 | -9×10^{-16} | -1280 | -7.8×10^{-16} |
| 20. $(\frac{4}{3})\text{NH}_4^+ + 2\text{O}_2 \rightarrow (\frac{4}{3})\text{NO}_2^- + (\frac{8}{3})\text{H}^+ + (\frac{4}{3})\text{H}_2\text{O}$ | -226 | -1.0×10^{-16} | -251 | -7.8×10^{-15} | -241 | -3.2×10^{-15} |
| 21. $4\text{NO}_2^- + 2\text{O}_2 \rightarrow 4\text{NO}_3^-$ | -248 | -5.6×10^{-15} | -213 | -2.9×10^{-16} | -221 | -4.0×10^{-15} |
| 22. $8\text{Fe}^{2+} + 2\text{O}_2 + 20\text{H}_2\text{O} \rightarrow 8\text{Fe}(\text{OH})_3 + 16\text{H}^+$ | -372 | -2.7×10^{-15} | -362 | -2.5×10^{-15} | -369 | -2.6×10^{-15} |

7.3 Shallow Groundwater Well Differentiation

The 16 favorable biogeochemical reactions were compared between the three shallow groundwater wells to see if the influx of WWTP effluent is affecting the native

microbial community. Figure 12 shows the FEF distributions for all favorable biogeochemical reactions in the three shallow groundwater wells. The favorable biogeochemical reactions are listed on the horizontal axis in the order of most to least favorable reaction for the pristine well. The vertical axis shows FEF values.

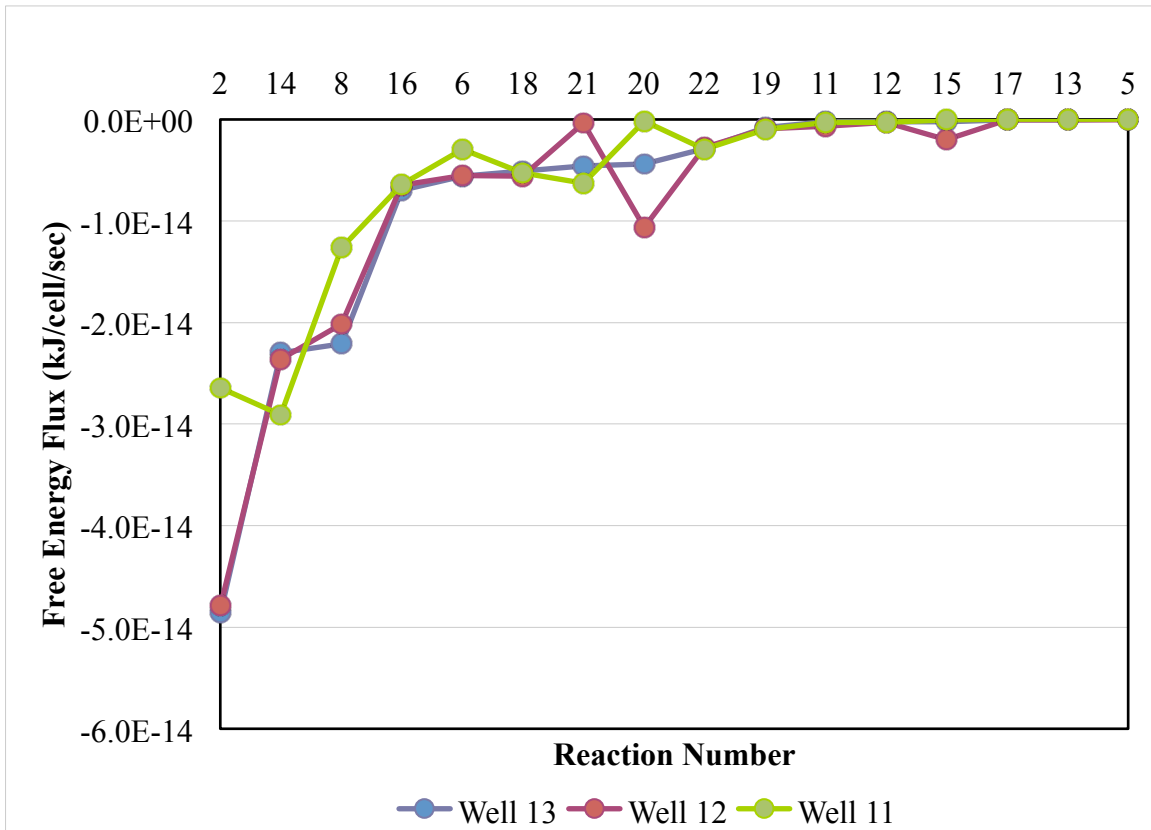

Figure 12. Free energy flux listed in order from most to least in the pristine well (Well 13). [Free energy flux (FEF), kilojoules per cell per second ($\text{kJ cell}^{-1} \text{s}^{-1}$)]

All three wells have similar distributions for the various metabolic pathways. Acetate oxidation using nitrate (reaction 2) is the most favorable metabolic pathway, with acetate oxidation using oxygen and acetate fermentation (reactions 14 and 8) being the next favorable, respectively. Five of the top six reactions are either heterotrophic reactions using acetate or methane, or acetate fermentation. The remaining reactions account for very little of the available FEF. Differences between the three wells are subtle and generally follow the same pattern.

Figures 13-15 show the available FEF distributions for the highly favorable heterotrophic and fermentation reactions in all three shallow groundwater wells.

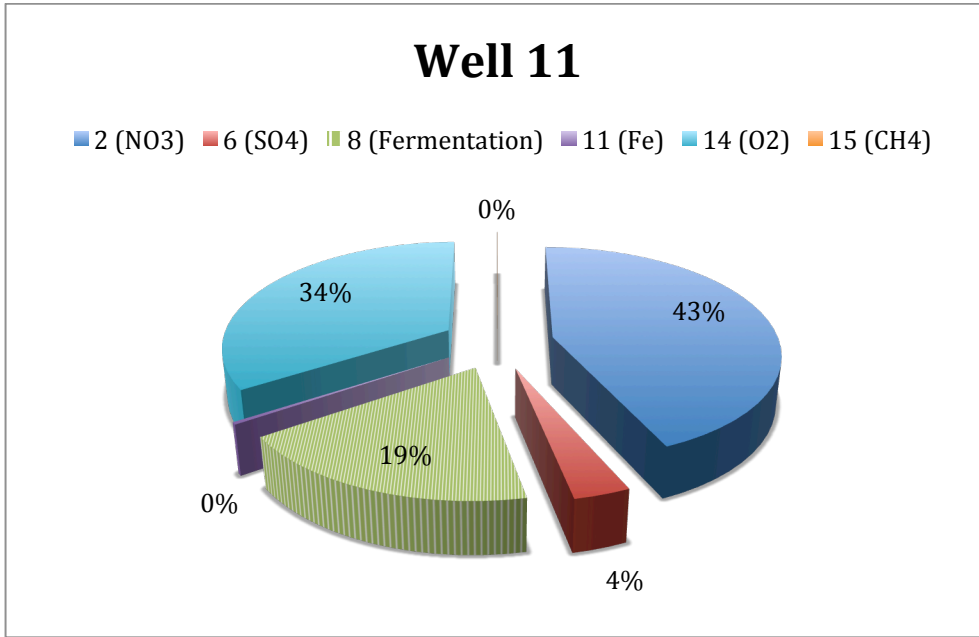

Figure 13. Free energy flux distributions for heterotrophic and fermentation metabolic pathways in Well 11 calculated using the limiting reactant. Legend represents reaction numbers described in Table 4.

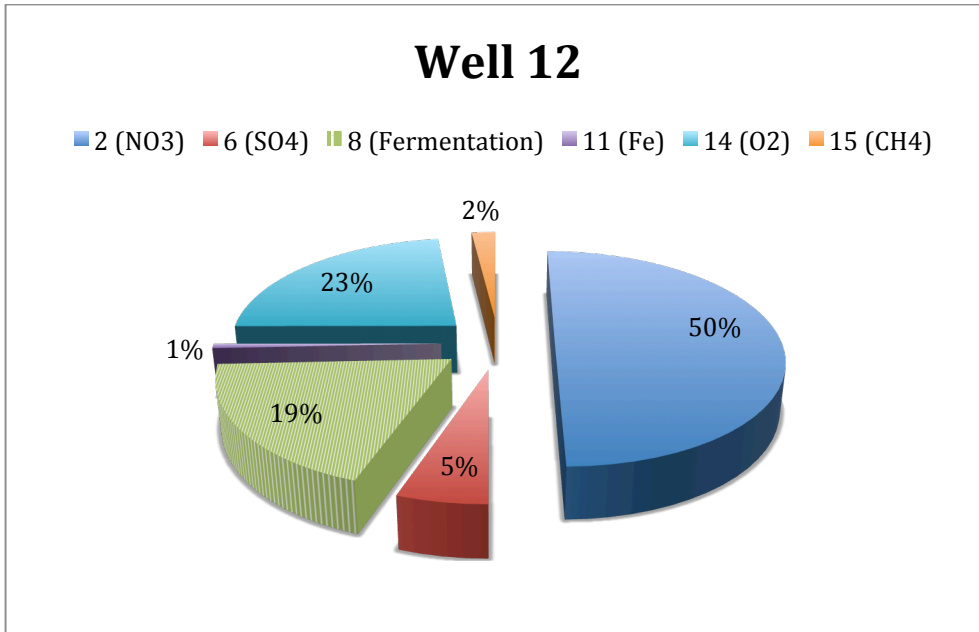

Figure 14. Free energy flux distributions for heterotrophic and fermentation metabolic pathways in Well 12 calculated using the limiting reactant. Legend represents reaction numbers described in Table 4.

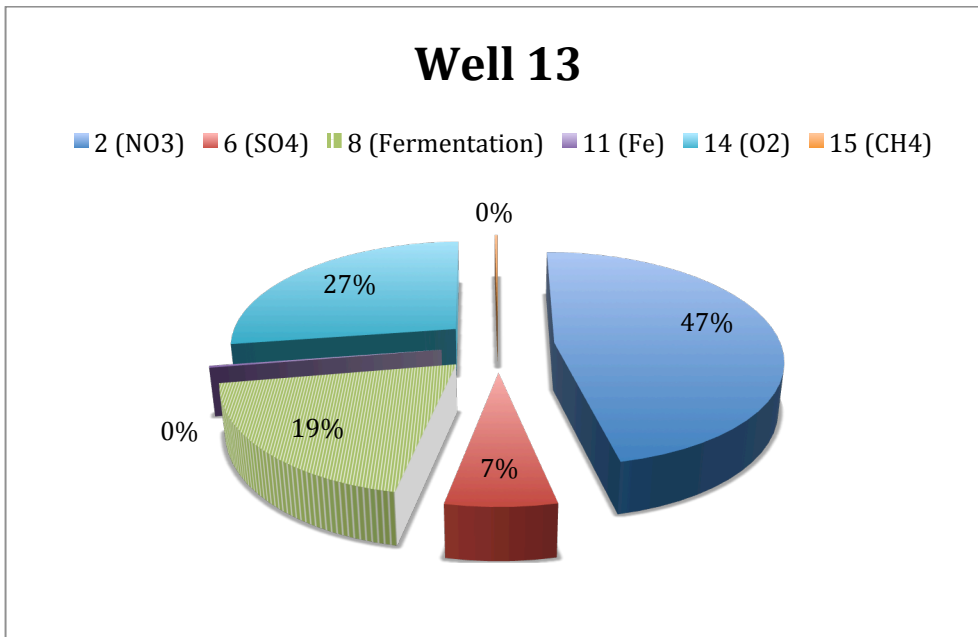

Figure 15. Free energy flux distributions for heterotrophic and fermentation metabolic pathways in Well 13 calculated using the limiting reactant. Legend represents reaction numbers described in Table 4.

FEF distributions were calculated using the limiting reactant of the equation, which determines the amount of free energy available for microorganisms to access. Among the heterotrophic reactions, nitrate is the primary available electron acceptor. Oxygen is the second most available electron acceptor after nitrate. RBI Well 12 and the pristine well, Well 13, appear to have similar distributions for FEF throughout all reactions. RBI Well 11 differs slightly with less available nitrate activity. Iron usage is more prevalent than expected, however, iron values are a maximum estimate since the limit of detection was used in thermodynamic calculations.

To ascertain the FEF actually being used in a given well as opposed to the total available FEF, the limiting constituent in Equation 6 was changed to include all constituents, not just the reactants. Figures 16-18 illustrate the relative amount of free energy actually being used for heterotrophic and fermentation reactions.

Comparisons between the available FEF (Figures 13-15) and the FEF actually being used (Figures 16-18) highlight several interesting features. Although there is an abundance of available fermentative FEF (reaction 8), very little is actually being used. Fermentation is used most in Well 12 (1%), compared to Well 11 or Well 13. Acetate oxidation by oxygen is dominant in all three wells, especially Well 11. The use of nitrate to oxidize acetate is the second most used in Well 12 and Well 13, at 32% and 19%, respectively; nitrate is more prevalent in Well 12. Ferrous iron is used to a greater extent (14-9%) than would be expected based on its contribution (1% or less) to the overall FEF. Acetate oxidation using sulfate is small and relatively constant in all three wells. The actual FEF used is approximately 10% of the total available.

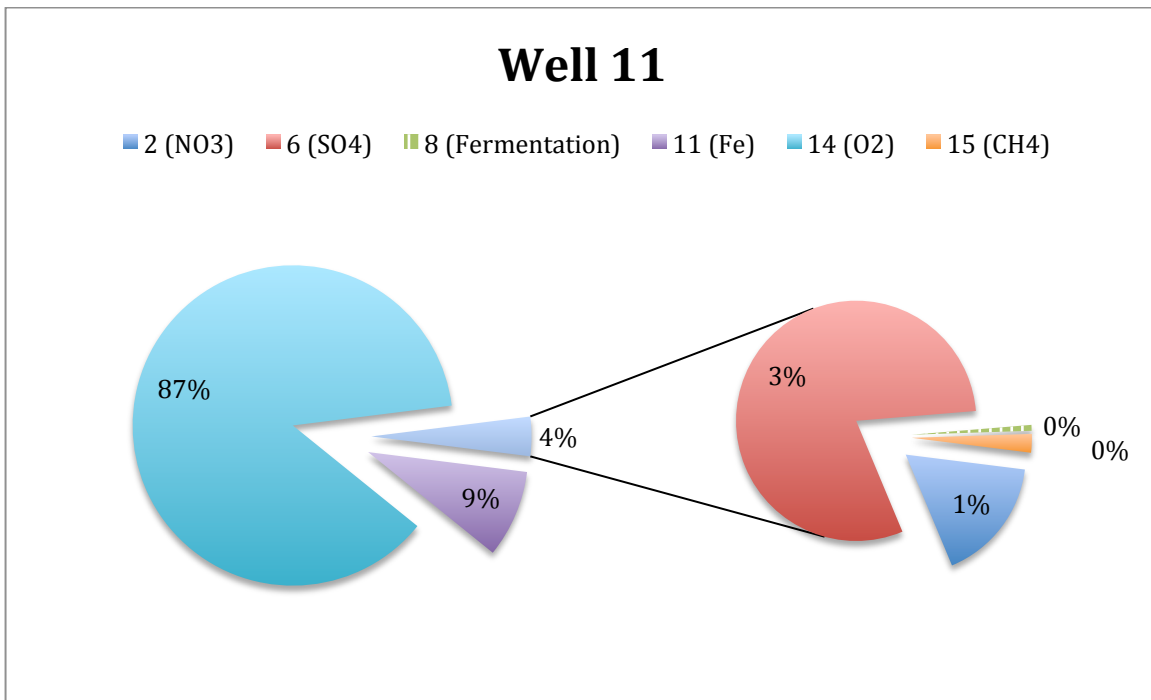

Figure 16. Free energy flux distributions for heterotrophic and fermentation metabolic pathways in Well 11 calculated using the overall limiting constituent. Legend represents reaction numbers described in Table 4.

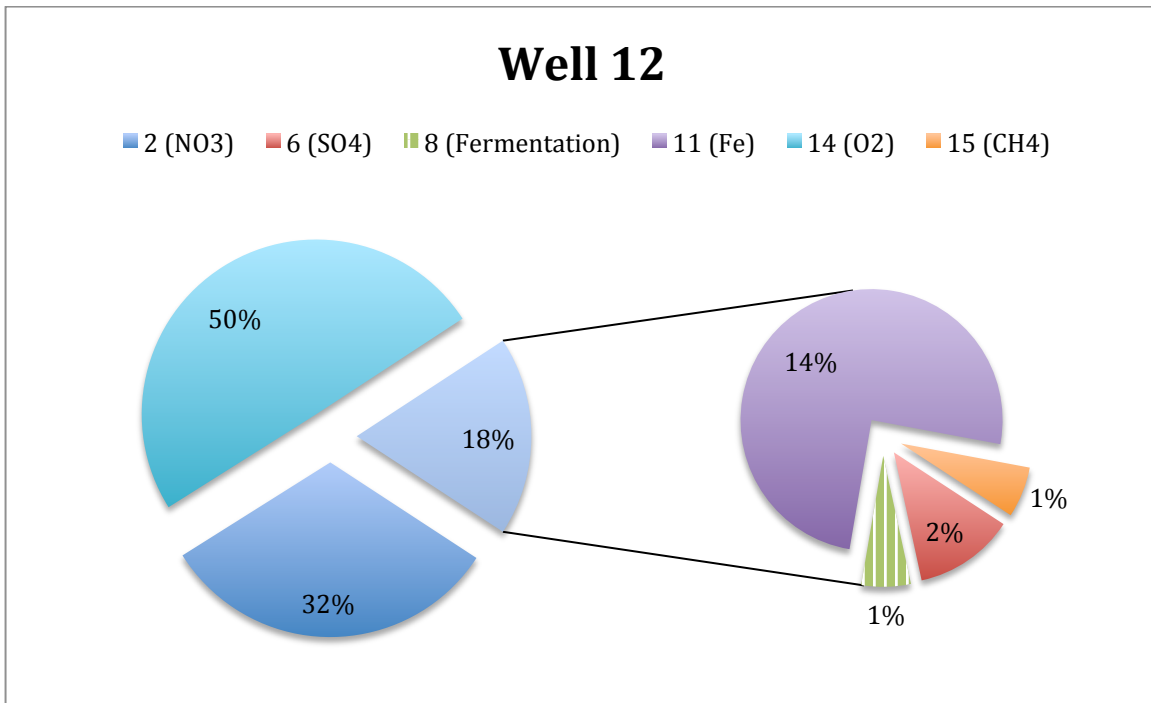

Figure 17. Free energy flux distributions for heterotrophic and fermentation metabolic pathways in Well 12 calculated using the overall limiting constituent. Legend represents reaction numbers described in Table 4.

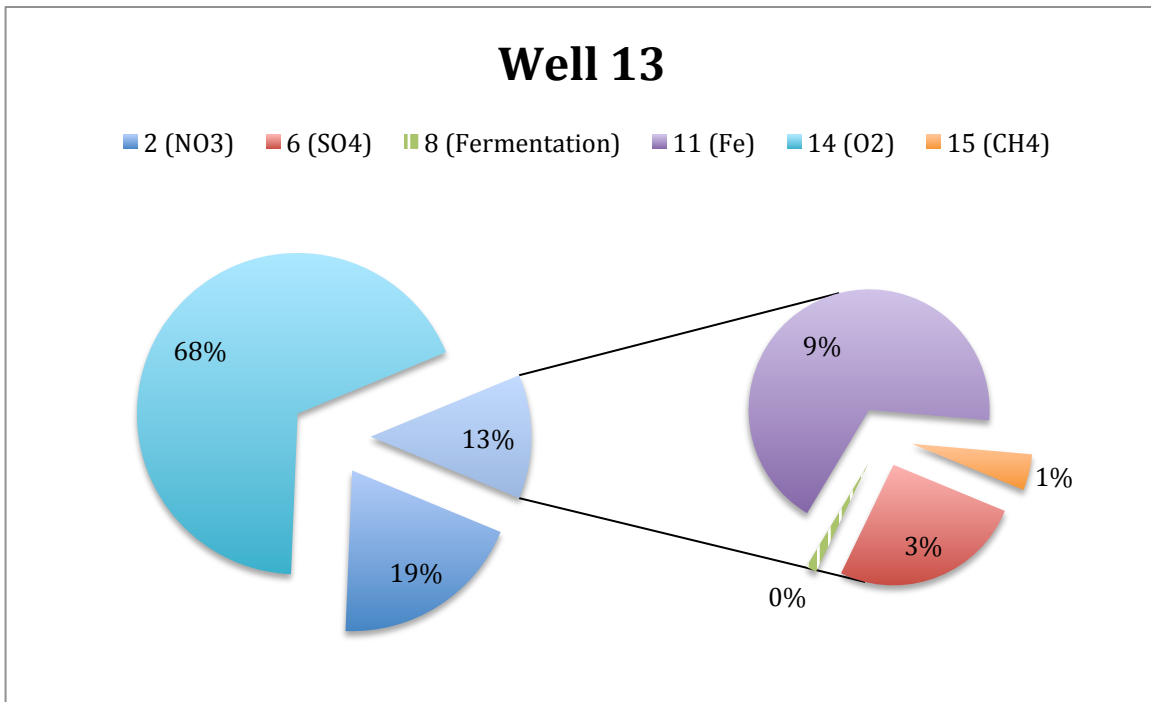

Figure 18. Free energy flux distributions for heterotrophic and fermentation metabolic pathways in Well 13 calculated using the overall limiting constituent. Legend represents reaction numbers described in Table 4.

Trends in FEF used indicate that Well 11 is closer to the pristine well (Well 13) than it is to Well 12. This is consistent with the fact that pumpage in Well 11 has been steadily declining and currently contributes less than 10% of the total pumpage out of the wellfield. As such, Well 11 pulls less water from the river than Well 12. This differential between the two RBI wells is also seen in the community data. It should be noted that the FEF analysis is limited to the high energy heterotrophic and fermentation reactions. Many autotrophic reactions are likely occurring, especially in the impacted RBI well (Well 12). The genomic data indicate the presence of several taxa capable of autotrophic nitrogen cycle reactions. For example, the relative decrease in nitrate, increase in nitrite and ammonium observed in Well 12 are classic conditions indicative of anammox reactions (Lams and Kuypers, 2011). The bacteria mediating this process were discovered in 1999. This newly discovered reaction converts nitrite and ammonium directly to nitrogen and water. Well 12 also exhibits a high FEF for ammonium oxidation (reaction 20 in Figure 12). Taxa capable of performing both of these reactions are found in the genomic data.

7.4 Microbial Community Diversity Analyses

The energetically favorable biogeochemical reactions were compared with metagenomic possibilities to gain an understanding of the aquifer biome and its associated reactivity with an influx of effluent. Natalie Gayner from the School of Freshwater Sciences completed microbial analyses. Preliminary 16S rRNA gene sequencing indicated distinct microbial community differences between the WWTP, Fox River, and RBI well Well 12 (Figure 19). Microorganisms were not observed to be transferring through the soil matrix from the Fox River into the shallow groundwater, as

assumed in thermodynamic analyses. Only river water and its mobile chemical constituents were observed to be entering the RBI wells. Furthermore, preliminary community composition analysis of 16S rRNA gene sequencing indicated predominantly novel taxa and typical groundwater organisms in the wells like denitrifiers, iron oxidizers, and sulfide oxidizers.

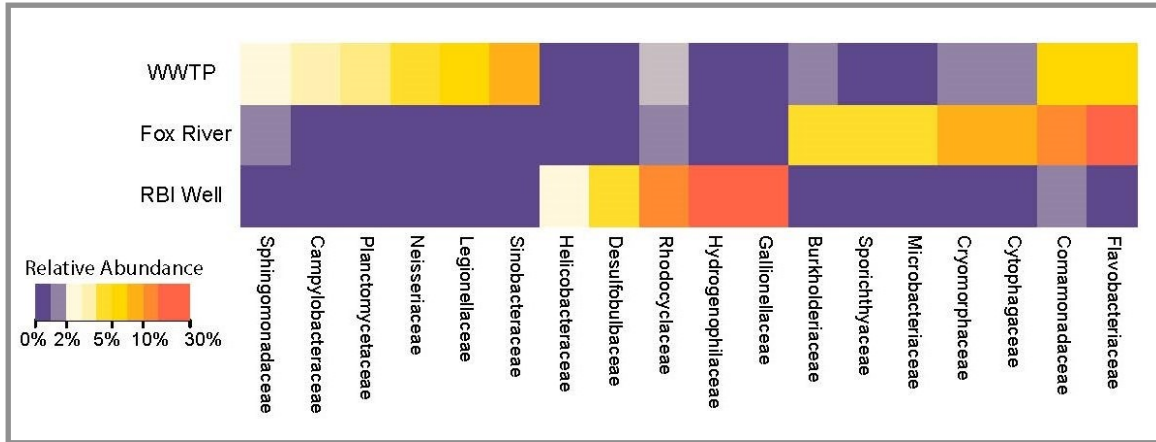

Figure 19. Heatmap showing the relative abundance of bacterial families (only families present at greater than 2% of the community composition in at least one sample depicted).

After preliminary analyses, extensive genomic samples were collected and data was statistically analyzed using the software R. After performing sequence data processing and rigorous quality control using DADA2 with an error rate of 0%, the sequence dataset (RNA and DNA, 0.1 μm and 0.2 μm fractions, from Well 11, Well 12, Well 13, and Fox River sites) included 51,331 unique amplicon sequence variants (ASVs), or taxa. Further processing in R removed sequences occurring at a relative abundance less than 0.01% in each sample. A threshold of 0.01% was chosen because it was strict enough to remove cross contamination of sequences among samples, however, rare community members were still included. Furthermore, the taxa that are in low abundances have little influence to overall community patterns. Using the threshold, the

dataset was cut down from 51,3331 to 21,910 unique amplicon sequence variants for analysis.

On Figure 20, the top 10 DNA and top 10 RNA amplicon sequence variants (ASVs), or unique 16S sequences that translate to unique organisms, were used to generate a heat map of relative abundance across all samples. A majority of the classifications resulted in the ASVs being unclassified/unknown due to groundwater being relatively unstudied. DNA is on the left and RNA is on the right, categorized by well and then by filter size. The most abundant organisms are not the same across samples. The color blue indicates 0% relative abundance and the warmer colors indicate higher relative abundances. There are observable differences between wells and filter sizes. Also, some ASVs were only identified in the RNA sequences. For example, the bottom unclassified ASV in Figure 20 is completely blue across all samples for DNA, indicating it is not present, however, the ASV was in the top ten most abundant organisms for the RNA sequences. Targeting strictly DNA may not be as all encompassing for the 16S rRNA gene practice.

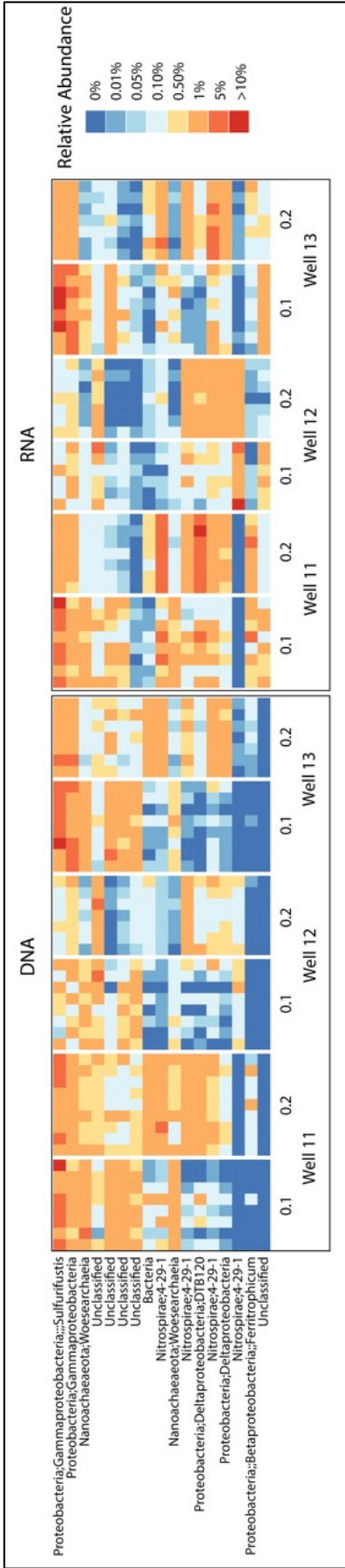

Figure 20. Heatmap of the top 10 most abundant DNA and RNA amplicon sequence variants (ASVs) categorized by filter size (0.1 μm and 0.2 μm) and well site.

Furthermore, organisms identifying with the recently discovered radiations called DPNN superphylum and CPR was discovered in the shallow groundwater wells. In this study, Nanoarchaea Woearchaea (DPNN) and Nitrospirae (CPR) were discovered that identify with the newly discovered microorganisms. Novel and newly discovered organisms having been identified in this study, which answers “who” is in each shallow groundwater well, however, there is little characterization about their metabolic capabilities of these novel organisms.

The full dataset of 21,910 unique ASVs, which includes all groundwater and Fox River samples (Well 11, Well 12, and Well 13), was used to compare microbial communities. A community distance matrix was developed using Bray-Curtis dissimilarity in the vegan package in R (Oksanen et al., 2013). Non-metric Multidimensional Scaling was used to develop an ordination of all microbial communities. Complex data with many dimensions were condensed down into two-dimensional space for easier visualization and interpretation. The Fox River and groundwater samples clearly cluster independently from each other as shown in Figure 21, indicating microbial communities of the groundwater wells and the Fox River are distinct from one another. Well 12 also clusters independently of Well 11 and Well 13. Well 11 and Well 13 do not cluster independently, likely due to the decrease in pumping in Well 11 allowing it to revert back to its natural aquifer state.

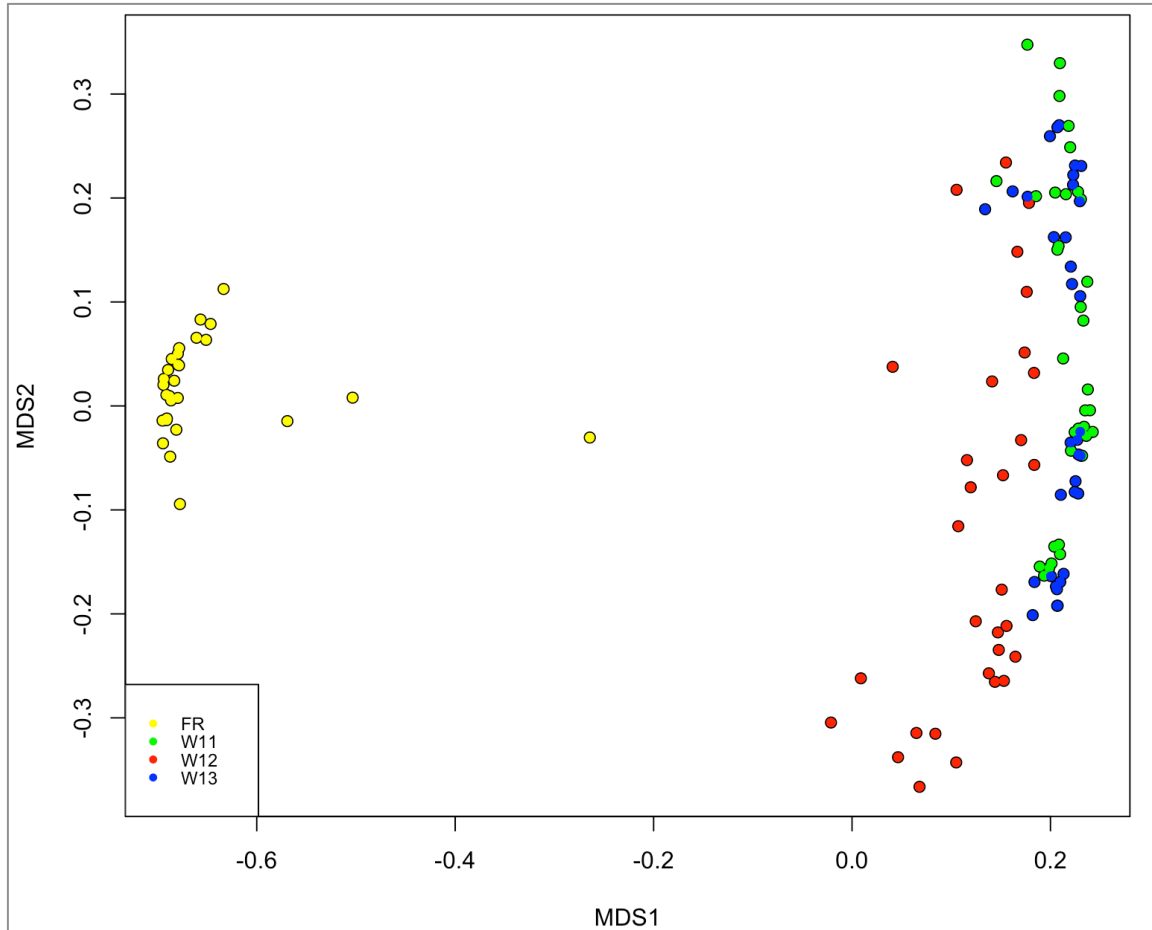

Figure 21. NMDS ordination of Fox River and groundwater microbial community samples.

The dataset consisting of just the groundwater samples (Well 11, Well 12, and Well 13) was used to compare groundwater microbial communities. In Figure 22, a dendrogram was generated in R for the entire groundwater dataset using hierarchical clustering of pairwise dissimilarity between samples using Bray-Curtis dissimilarity in the *vegan* package in R (Oksanen et al., 2013). A dendrogram is a tree diagram that depicts taxonomic relationships. The height at which the branches merge at each node is relative to their similarity showing relationships between the samples.

The first branch split (right to left) and therefore the largest factor contributing to the variation in the dataset is site location. Well 12 is different from Well 11 and Well 13.

The factor driving the second largest difference in the dataset is filter size. The 0.1 μm and 0.2 μm communities differ within the dataset. The third factor driving a difference is, again, site location between Well 11 and Well 13. The last factor significantly contributing to a difference in the dataset is RNA and DNA.

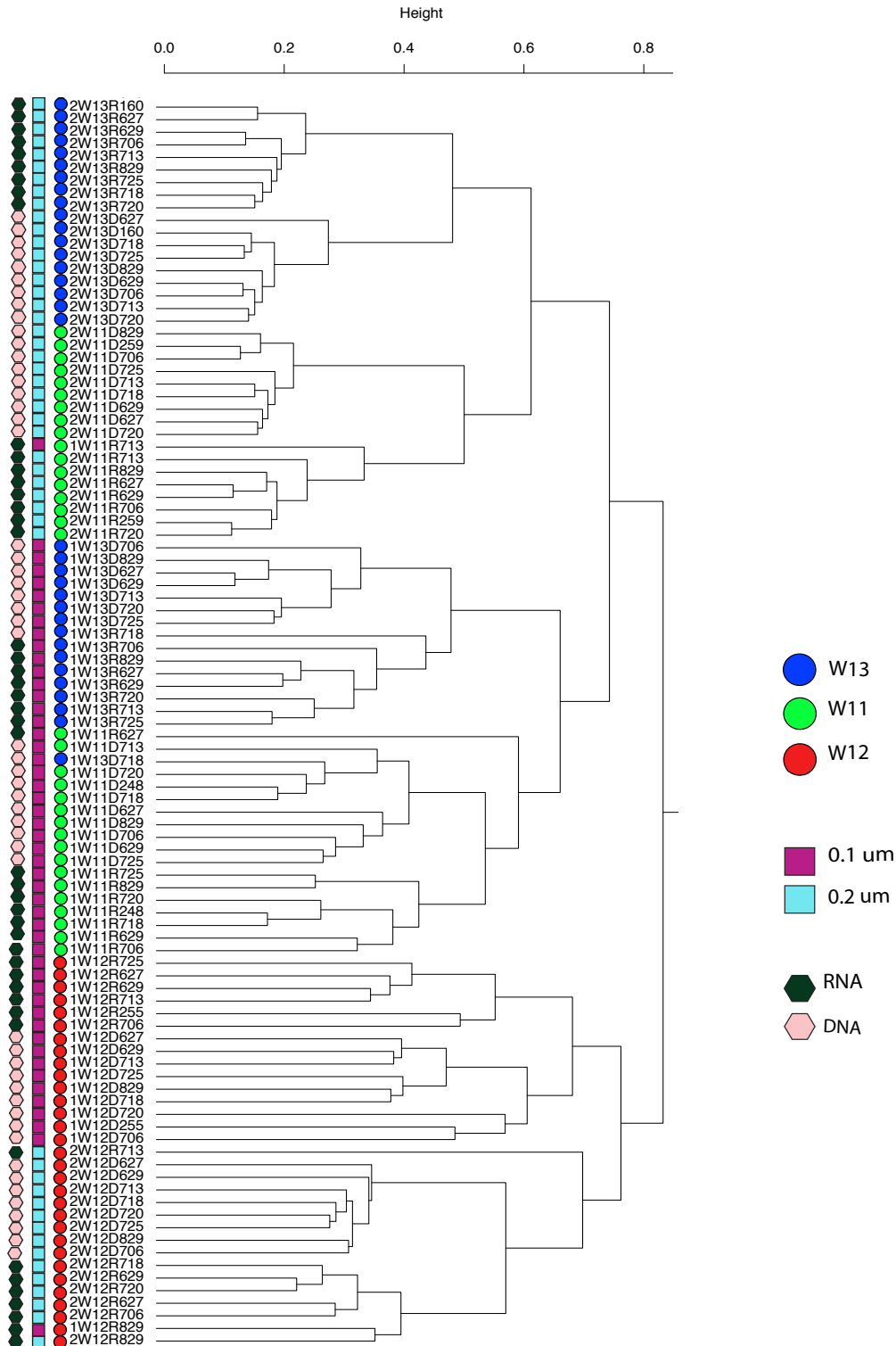

Figure 22. Groundwater microbial community dendrogram. NMDS and Bray-Curtis dissimilarity were used to generate a dendrogram demonstrating the differences across groundwater microbial community samples. The groundwater microbial communities cluster first by well location in that W12 is significantly different from the other two wells. Filter size fraction then cluster together, then Well 13 and Well 11 cluster separately, and then RNA and DNA cluster together.

Overall, the data indicates that the microbial community in Well 12 (RBI well actively drawing in river water) differs from Well 11 (former RBI well) and Well 13 (pristine well). This suggests that the former RBI well does not draw in river water and is returning to a state similar to the non-river infiltrated groundwater. The data also shows that bacterial size is a significant differentiator in microbial communities and explains community variation in Well 11 and Well 13. This means, the 0.1 μm communities in Well 11 are more similar to the 0.1 μm communities in Well 13 than to the 0.2 μm communities in Well 11, the same location, and vice versa.

Chapter 8: Conclusions

Microorganisms are also known to be key players in biogeochemical reactions that influence water quality and treatment processes. This study investigated if, and to what extent the microbial community present in the shallow groundwater of southeastern Wisconsin is affected by the influx of treated municipal wastewater effluent. This study combined two graduate students' research by merging geochemical analysis and microbial analyses to obtain a more complete picture of a valuable freshwater resource.

Thermodynamic analyses show 16 favorable biogeochemical reactions applicable to the shallow groundwater wells (Table 6). Trends in FEF used indicate that Well 11 is closer to the pristine well (Well 13) than it is to the impacted RBI well (Well 12). This is consistent with the fact that pumpage in Well 11 has been steadily declining and currently contributes less than 10% of the total pumpage out of the wellfield. Electrons are being transferred via several mechanisms. Many autotrophic reactions are likely occurring, especially in Well 12, however, FEF analysis was limited to the high energy heterotrophic and fermentation reactions. Nitrate and oxygen are dominant electron acceptors, while iron and sulfate account for very little. The actual FEF used is approximately 10% of the total available.

Microbial community analyses showed many unclassified and novel taxa have been discovered in the shallow groundwater wells. The novel taxa are found within the recently discovered ASVs that have expanded the tree of life. Genomic differences of this type have been observed before in deep aquifers, but never in such a shallow system. Because the microorganisms are newly discovered, not much is known about their functional capabilities. Well 12 communities differ most greatly from Well 11

(previously impacted) and Well 13 (pristine) communities (Figure 22), and there are observable differences between filter sizes.

Because so many taxa are undefined, trends between thermodynamic and microbial data are approximate, however, the genomic and the thermodynamic datasets are consistent. The taxa associated with the shallow groundwater microbial communities suggest the potential for fermentation, methanogenesis, nitrate reduction, sulfate reduction, nitrite oxidation, iron oxidation, and sulfur oxidation in the aquifer. RBI Well 12 contains specialists related to chemoautotrophs, methylotrophs, fermenters, sulfur-oxidizers (*Rhodocyclaceae*), sulfate reduction and nitrite oxidation (*Nitrospirae*), and iron or methane metabolisms (Woesarchaeota). The pristine well contains specialists potentially related to nitrite reduction, fermentation (Parcubacteria), iron oxidation (*Gallionellaceae*), and sulfur oxidation (*Sulfurifustis*). In thermodynamic analyses, FEF distributions show the related thermodynamic pathways for the taxa associated with the shallow groundwater are favorable.

Understanding groundwater systems will only become increasingly more valuable with increasing demands for freshwater and as natural and anthropogenic contamination threatens these vital water resources. The methods and results of this study are applicable to other groundwater systems and can be invaluable to the scientific community due to the relatively unstudied nature of microbial systems in groundwater, which can lead to discovering new life.

References

- Amend, J. and Shock, E., 2001, Energetics of overall metabolic reactions of thermophilic and hyperthermophilic Archaea and Bacteria: *FEMS Microbiology Reviews*, v. 25, p. 175-243.
- Ball, J., and D. Nordstrom. 1991. User's annual for WATEQ4F, with revised thermodynamic data base and text cases for calculating speciation of major, trace, and redox elements in natural waters. Open-File Report 91-183.
- Cape, M. and T. Grundl. 2006. Geochemical Factors Controlling Radium Activity in a Sandstone Aquifer. *Ground Water* 44(4):518-527.
- Castelle, C. J., Wrighton, K. C., Thomas, B. C., Hug, L. A., Brown, C. T., Wilkins, M. J., ... Banfield, J. F. (2015b). Genomic expansion of domain archaea highlights roles for organisms from new phyla in anaerobic carbon cycling. *Current Biology*, 25(6), 690–701. <https://doi.org/10.1016/j.cub.2015.01.014>
- Davidson, M., Silver, B., Onstott, T., Moser, D., Gihring, T., Pratt, L., Boice, E., Lollar, B., Lippmann-Pipke, J., Piffner, S., Kieft, T., Seymore, W., and Ralston, C., 2011, Capture of planktonic microbial diversity in fractures by long-term monitoring of flowing boreholes, Evander Basin, South Africa: *Geomicrobiology Journal*, v. 28, p. 275–300.
- Delmont, T. O., Simonet, P., & Vogel, T. M. (2012). Describing microbial communities and performing global comparisons in the 'omic era. *The ISME Journal*, 6(9), 1625–1628. <http://doi.org/10.1038/ismej.2012.55>
- Eme, L., Ford Doolittle, W. (2015). Microbial diversity: A bonanza of phyla. *Current Biology*, 25(6), R227–R230. <https://doi.org/10.1016/j.cub.2014.12.044>
- Feinstein, D., Cherkauer, D., and Grundl, T. 2010. Examining the viability of riverbank inducement (RBI) as another source of water in Wisconsin. USGS & UWM: Community Presentation.
- Fields-Sommers, Laura Rachel, "Assessing the Effects of Riverbank Inducement on a Shallow Aquifer in Southeastern Wisconsin" (2015). *Theses and Dissertations*. 1049. <https://dc.uwm.edu/etd/1049>
- Fox River Study Group, Inc. 2018.
- Gaumnitz, Lisa, et al. "A Growing Thirst for Groundwater." *Wisconsin Natural Resources*, June 2004.

- Hug, L. A., Baker, B. J., Anantharaman, K., Brown, C. T., Probst, A. J., Castelle, C. J., ... Banfield, J. F. (2016). A new view of the tree of life. *Nature Microbiology*, 1(5). <https://doi.org/10.1038/nmicrobiol.2016.48>
- Klump, S., Grundl, T., Purtschert, R., Kipfer, R. 2008. Groundwater and climate dynamics derived from noble gas, ^{14}C , and stable isotope data. *Geology*; 36 (5): 395–398. doi: <https://doi.org/10.1130/G24604A.1>
- Lam, Phyllis, and Marcel M.m. Kuypers. “Microbial Nitrogen Cycling Processes in Oxygen Minimum Zones.” *Annual Review of Marine Science*, vol. 3, no. 1, 2011, pp. 317–345., doi:10.1146/annurev-marine-120709-142814.
- Lin, X., McKinley, J., Resch, C. T., Kaluzny, R., Lauber, C. L., Fredrickson, J. Knight, R., and Konopka, A. 2012. Spatial and temporal dynamics of the microbial community in the Hanford unconfined aquifer. *ISME J.* 6:1665-1676.
- Liu, X., Li, M., Castelle, C. J., Probst, A. J., Zhou, Z., Pan, J., ... Gu, J.-D. (2018). Insights into the ecology, evolution, and metabolism of the widespread Woesearchaeotal lineages. *Microbiome*, 6(1), 102. <https://doi.org/10.1186/s40168-018-0488-2>
- Lisle, J.T. 2014. Survival of Bacterial Indicators and the Functional Diversity of Native Microbial Communities in the Floridan Aquifer System, South Florida: U.S. Geological Survey Open–File Report 2014-1011, 70 p., <http://dx.doi.org/10.3133/ofr20141011>
- Luef, B., Frischkorn, K. R., Wrighton, K. C., Holman, H.-Y. N., Birarda, G., Thomas, B. C., Singh, A., Williams, K. H., Siegerist, C. E., Tringe, S. G., Downing, K. H., Comolli, L. R. and Banfield, J. F. 2015. Diverse uncultivated ultra-small bacteria cells in groundwater. *Nat. Commun.* 6:6372.
- McCoy, Mary Kate. “As Wells Go Deeper, Radium Levels Rise in State Tap Water.” *WisconsinWatch.org*, 31 Mar. 2016, wisconsinwatch.org/2016/03/as-wells-go-deeper-radium-levels-rise-in-state-tap-water/
- National Oceanic and Atmospheric Association. <https://www.ncdc.noaa.gov/cdo-web/datasets/ANNUAL/stations/COOP:478937/detail>
- Oksanen, J., Blanchet, F. G., Kindt, R., Legendre, P., Minchin, P. R., O’Hara, R. B., ... Wagner, H. (2013). Package ‘vegan.’ *R Package Ver. 2.0–8*, 254. <https://doi.org/10.4135/9781412971874.n145>
- Onstott, T., 2005, Impact of CO₂ injections on deep subsurface microbial ecosystems and potential ramifications for the surface biosphere, in Benson, S., Oldenburg, C., Hoversten, M., Imbus, S., eds., Carbon Dioxide Capture for Storage in Deep

Geologic Formations—Results from the CO₂ Capture Project: Elsevier, p. 1207–1239.

- Parada, A. E., Needham, D. M., & Fuhrman, J. A. (2016). Every base matters: Assessing small subunit rRNA primers for marine microbiomes with mock communities, time series and global field samples. *Environmental Microbiology*, *18*(5), 1403–1414. <https://doi.org/10.1111/1462-2920.13023>
- Parkhurst, D., and Appelo, C. 2005. User's Guide to PHREEQC (Version 2)- A computer program for speciation, batch-reaction, one-dimensional transport, and inverse geochemical calculations. United States Geological Survey (USGS).
- Rinke, C., Schwientek, P., Sczyrba, A., Ivanova, N. N., Anderson, I. J., Cheng, J. F., ... Woyke, T. (2013). Insights into the phylogeny and coding potential of microbial dark matter. *Nature*, *499*(7459), 431–437. <https://doi.org/10.1038/nature12352>
- Shink B. 1997. Energetics of syntrophic cooperation in methanogenic degradation. *Microbiol Mol Biol Rev* 61:262–280.
- Smith, R. J., Jeffries, T. C., Roudnew, B., Fitch, A. J., Seymour, J. R., Delpin, M. W., Newton, K., Brown, M. H., and Mitchell, J. G. 2012. Metagenomic comparison of microbial communities inhabiting confined and unconfined aquifer ecosystems. *Environ. Microbiol.* 14:240-253.
- Thauer, R., Jungermann, K., and Decker, K., 1977, Energy conservation in chemotrophic anaerobic bacteria: *Bacteriological Reviews*, v. 41, p. 100–180.
- Thorp, Anna Maria, "Applying Geochemistry to Investigate the Occurrence of Riverbank Inducement into a Shallow Aquifer in Southeastern Wisconsin" (2013). *Theses and Dissertations*. 240. <https://dc.uwm.edu/etd/240>
- Vengosh, A., Starinsky, A., Kolodny, Y., and Chivas, A.R., 1991. Boron isotope geochemistry as a tracer for the evolution of brines and associated hot springs from the Dead Sea, Israel. *Geochemica et Cosmochimica Acta*, *55*: 1689-1695.
- Walters, W., Hyde, E. R., Berg-Lyons, D., Ackermann, G., Humphrey, G., Parada, A., ... Knight, R. (2016). Improved Bacterial 16S rRNA Gene (V4 and V4-5) and Fungal Internal Transcribed Spacer Marker Gene Primers for Microbial Community Surveys. *MSystems*, *1*(1), e00009-15. <https://doi.org/10.1128/mSystems.00009-15>
- Waukesha County. <https://www.waukeshacounty.gov/globalassets/parks--land-use/planning-zoning/chapter-3-final-ag-cultur-natur-print-ready.pdf>.
- Waukesha Water Utility. 2014. Public Radium Notice. Public Notice.

Waukesha Water Utility, Waukesha Water Utility, 18 Sept. 2017.

APPENDICES

APPENDIX A:
Sample Collection Information

Coordinates of Sampling Sites in Decimal Degrees

| Sampling Site | Latitude | Longitude |
|----------------------|-----------------|------------------|
| EM275 | 43.099327 | -88.103161 |
| IZ385 | 43.063351 | -88.183740 |
| IZ386 | 43.051841 | -88.176827 |
| SV631 | 42.901237 | -88.059776 |
| Well 11 | 42.959938 | -88.279256 |
| Well 12 | 42.961012 | -88.279063 |
| Well 13 | 42.961236 | -88.289167 |
| Hygeia Spring | 42.879817 | -88.205125 |
| Fox 0 | 43.120068 | -88.164715 |
| Fox 1 | 43.011395 | -88.234244 |
| Fox 2 | 42.977690 | -88.264797 |
| Fox 3 | 42.876283 | -88.210559 |
| Root River | 42.858027 | -87.997586 |
| Sussex Creek | 43.102008 | -88.210367 |
| Underwood Creek | 43.042935 | -88.056498 |
| Brookfield WWTP | 43.052745 | -88.177110 |
| Sussex WWTP | 43.126171 | -88.216985 |
| Waukesha WWTP | 42.998190 | -88.249151 |

Contacts for Sampling Sites

| Municipality | Contact Person | Contact Information | Location |
|--------------------------|-----------------------|--|---------------------------------------|
| Brookfield Water Utility | Mike Terry | Telephone: (262) 796-6717 Email: terrym@ci.brookfield.wi.us | 19700 Riverview Drive, Brookfield, WI |
| St. Martin of Tours | Tom Breedom | Telephone: (414) 333-47000 | 7963 South 116 St, Franklin, WI |
| Waukesha Water Utility | Randy Dehn | Email: rdehn@waukesha-water.com | 3815 Creekside Drive, Waukesha, WI |
| Brookfield WWTP | Bob Berenson | Email: berenson@ci.brookfield.wi.us | 21225 Enterprise Ave, Brookfield, WI |
| Sussex WWTP | Jon Baumann | Telephone: (262) 246-5184 | 23525 Clover Drive, Sussex, WI |
| Waukesha WWTP | Greg Markle | Telephone: (262) 524-3631 Email: gmarkle@waukesha-wi.gov | 600 Sentry Drive, Waukesha, WI |

Microseeps Gas Stripping Instructions



Microseeps Gas Stripping Cell Instructions

INSTALLATION AND OPERATION

To place the gas stripping cell into service:

1. Remove one of the cell assemblies from the packing carton. Refer to Figure 1 to become familiar with the parts of the cell.
2. Connect the inlet tube of the cell to the outlet of your pump. The inlet tube is designed to connect to ¼ inch O.D. hard tubing. Secure the connection (nylon wire ties are recommended).
3. Insert the drain tube of the cell into a waste container, keeping the end of the tube at the bottom of the container. Any waste container of suitable size may be used. A 2-liter soda pop bottle may be placed in the waste container to determine pumping flow rate.
4. Secure the cell assembly so that the housing cover is above the glass housing (*i.e.* upright). A ring stand and clamp are recommended for this purpose.
5. Turn the pump on and check for leaks. If any leaks are found seal them before proceeding. Measure, in ml per minute, the flow rate of the pump. If a 2-liter soda pop bottle was used, the flow rate can be determined by measuring how many minutes it takes to fill the bottle, then substituting the measured time into the following equation.

Flow = 2000 ml/time to fill in minutes

Consult Table 1 to determine the equilibrium time needed to gas strip at this flow rate.

NOTE: Use a flow rate between 100 ml/min and 500 ml/min. Do not turn off the pump.

6. Unclamp the cell assembly, invert it and re-secure the assembly in the inverted position. Make sure the drain tube is still in the waste container and the end of the drain tube is near the bottom of the bottle.
7. Connect the (supplied) stopcock to the syringe and the (supplied) needle to the stopcock. Place the stopcock in the open position (*i.e.* so that the stopcock handle is in-line with the syringe). Draw the plunger back on the syringe to the 20.0-mL mark. Keeping the cell in the inverted position, insert the needle into the needle guide. Pierce the septum and inject the air into the cell. Then remove the needle and syringe from the assembly and carefully cover the needle. Do not discard the syringe apparatus.

8. Start timing and let the ground water pump through the cell for the time specified in Table 1 for your particular pumping speed. Meanwhile, be sure that the sample vial is properly labeled and that the flow rate and any other relevant field data are recorded in the field log.

NOTE: Be sure to keep the end of the drain tube at the bottom of the waste container. This will insure that outside air is not drawn into the cell. Failure to do this will invalidate the sample.

When the equilibration time is up, **turn off the pump**, unclamp the cell and reclamp it in its upright position. Verify that the plunger of the syringe is pushed all the way in and that the stopcock is in the open position, then insert the needle into the needle guide and pierce the septum. Withdraw 1-mL of gas by pulling back on the syringe plunger while holding the syringe body in place, remove the syringe from the cell and expel the sample. Immediately re-insert the needle into the needle guide and pierce the septum. Withdraw a 15-mL sample of gas and, with the needle still through the septum, close the stopcock. Rapidly withdraw the needle from the septum and place it through septum on the sample vial (see Figure 2). Open the stopcock and completely depress the syringe barrel. Discard the syringe apparatus according to Local, State and Federal regulations.

Decontamination/Cleaning

Pump at least 1 liter of potable water through the cell. The cell assembly is now ready for re-use.

The only expendable part of the cell is the sampling septum (part 7). Normally, each septum may be used for the collection of up to 5 samples. If bubbles are seen rising up from the septum when the cell is inverted the septum MUST be replaced. Instructions for replacing the septum are provided on the reverse.

SAMPLING QUESTIONS?

CALL PAES AT 1-412-826-5245
MON.- FRI. 9 TO 5 PM EST

Figures and Tables on Reverse

Figure 1. Cross section of Microseeps Gas Stripping Cell

1. Housing Cover
2. Jet Spray Nozzle
3. Nylon Tie
4. Inlet Tube
5. Needle Guide Port
6. Drain Tube
7. Replaceable Septum
8. Glass Housing

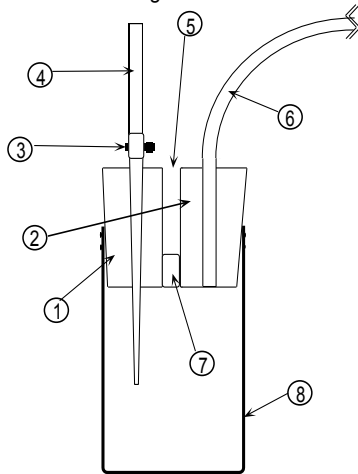

Figure 2. Cross section of septum bottle

1. Septum
2. Metal Closure
3. Glass vial

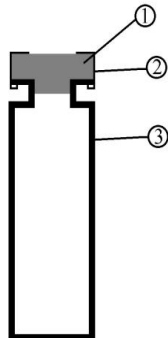

Table 1.

| Flow rate (ml/min) | Sampling time (min) |
|-----------------------|------------------------|
| 100-120 | 30 |
| 130-150 | 25 |
| 160-200 | 20 |
| 210-300 | 15 |
| >300 | 10 |

Replacing the Sampling Port Septum

All part numbers refer to Figure 1.

1. Remove the housing cover (part 1) from the glass housing (part 8).
2. Use a handy, blunt tipped object to push the replaceable septum (part 7) out of the housing cover. The cover to a needle works well for this purpose, but be sure that the needle is **NOT** in the cover. Discard the old septum.
4. Take a new septum and wet both the new septum and the housing cover with potable water.
5. Carefully using the same blunt instrument used in step three above, slide the new septum into the hole from which the old septum was removed. The bottom of the new septum must be flush with the narrow end of the housing cover.
6. If the housing cover is not still wet, wet it again with potable water. Place the bottom end of the housing cover into the glass housing and push it in until less than 3/8" are above the rim of the glass housing. This may require some force.
7. Follow the cleaning procedures described above to prepare the cell for a return to service.

APPENDIX B:
Field and Analytical Results

Field Analysis

Field Analysis Parameters

| Name | Date | pH | Specific Conductivity (mmhos/cm) | Temperature (°C) | Dissolved Oxygen by Meter (mg/L) | Calculated HCO₃⁻ |
|-------------|-------------|-----------|---|-------------------------|---|---|
| EM275 | 11/2/16 | 7.03 | 0.77 | 9.90 | 0.26 | NA |
| EM275 | 8/25/17 | 7.02 | NA | 10.20 | 0.55 | 324.52 |
| IZ385 | 11/2/16 | NA | 0.04 | 6.79 | 1.05 | NA |
| IZ385 | 8/25/17 | 6.89 | NA | 11.50 | 0.49 | 407.48 |
| IZ386 | 11/2/16 | 6.81 | 1.30 | 11.20 | 0.06 | NA |
| SV631 | 11/7/16 | 7.11 | 0.81 | 14.90 | 0.09 | 472.15 |
| SV631 | 9/15/17 | 7.51 | NA | 17.50 | 0.29 | 361.12 |
| Well 11 | 11/3/16 | 6.85 | 1.23 | 6.95 | 0.16 | 522.33 |
| Well 11 | 2/28/17 | 6.68 | 1.28 | 10.00 | 0.13 | 616.98 |
| Well 11 | 7/27/17 | 7.00 | NA | 10.50 | 0 | NA |
| Well 11 | 8/1/17 | 7.05 | NA | 10.50 | 0 | 541.68 |
| Well 11 | 11/8/17 | 7.19 | 1.20 | 10.30 | NA | 395.28 |
| Well 11 | 11/29/17 | 6.90 | NA | NA | NA | 390.40 |
| Well 11 | 12/1/17 | 6.84 | NA | NA | NA | 397.72 |
| Well 11 | 1/26/18 | 7.06 | 0.96 | 10.20 | NA | 431.88 |
| Well 12 | 11/3/16 | 7.05 | 1.17 | 10.40 | 0.04 | 469.84 |
| Well 12 | 2/28/17 | 6.97 | 0.18 | NA | 0.01 | 600.39 |
| Well 12 | 7/27/17 | 6.50 | NA | 10.40 | 0.25 | NA |
| Well 12 | 8/1/17 | 6.90 | NA | 10.50 | 0.39 | 636.84 |
| Well 12 | 11/8/17 | 7.18 | NA | 10.60 | 0.02 | 370.88 |
| Well 12 | 11/29/17 | 7.15 | 0.65 | 10.80 | 0.11 | 356.24 |
| Well 12 | 12/1/17 | 7.08 | NA | NA | NA | 353.80 |
| Well 12 | 1/26/18 | 6.97 | NA | NA | NA | 424.56 |
| Well 13 | 11/17/16 | 6.96 | 0.93 | 10.50 | 0.00 | 453.01 |
| Well 13 | 2/28/17 | 5.14 | 0.95 | 10.50 | 0.00 | 563.86 |
| Well 13 | 7/27/17 | 7.50 | NA | 10.50 | 0.30 | NA |

Field Analysis Parameters (Continued)

| | | | | | | |
|-----------------|----------|------|-------|-------|-------------|--------|
| Well 13 | 8/1/17 | 7.21 | NA | 10.50 | 0.00 | 468.48 |
| Well 13 | 11/8/17 | 7.21 | NA | 10.50 | 0.46 | 324.52 |
| Well 13 | 11/29/17 | 7.10 | NA | NA | NA | 363.56 |
| Well 13 | 12/1/17 | 7.12 | NA | NA | NA | 351.36 |
| Well 13 | 1/26/18 | 7.15 | 0.79 | 10.50 | NA | 390.40 |
| Hygeia Spring | 11/7/16 | 6.87 | 0.87 | 12.70 | 6.43 | 392.03 |
| Hygeia Spring | 8/20/17 | 6.90 | NA | NA | 6.59 | 315.98 |
| Fox 0 | 11/7/16 | 7.49 | 0.90 | 10.50 | Fox 0 | 448.00 |
| Fox 0 | 8/5/17 | 7.10 | 0.81 | 19.80 | Fox 0 | 341.60 |
| Fox 1 | 11/7/16 | 6.90 | 1.06 | 10.80 | 10.00 | 420.60 |
| Fox 1 | 8/19/17 | 8.09 | NA | 23.50 | 6.95 - 7.21 | 317.20 |
| Fox 2 | 11/7/16 | 7.59 | 1.20 | 12.80 | 9.96 | 390.00 |
| Fox 2 | 8/20/17 | 7.92 | NA | 23.50 | 4.14 | 353.80 |
| Fox 3 | 11/7/16 | 6.86 | 0.92 | 10.70 | 7.00 | 386.55 |
| Fox 3 | 8/20/17 | 7.58 | NA | NA | 1.6 - 1.89 | 422.12 |
| Root River | 11/7/16 | 6.81 | 1.06 | 9.40 | 8.70 | 413.36 |
| Root River | 8/31/17 | 8.32 | NA | 19.80 | 6.40 | 283.04 |
| Sussex Creek | 11/7/16 | 8.09 | 1.34 | 13.10 | 12.37 | 451.76 |
| Sussex Creek | 8/5/17 | 8.36 | NA | 19.00 | 5.43 | 351.36 |
| Underwood Creek | 11/7/16 | 8.44 | 14.22 | 13.80 | 19.00 | 346.23 |
| Underwood Creek | 8/20/17 | 8.36 | NA | 24.10 | 13.40 | 270.84 |

Atomic Absorption Spectroscopy with Calibration Curves for Major Ions

Calcium Standards AA Spectrometer Fall 2016

| Standard | Concentration (mg/L) | Absorption Start | Absorption Final | Absorption Average |
|----------|----------------------|------------------|------------------|--------------------|
| Blank | 0 | 0.0037 | 0.0035 | 0.0035 |
| 1 | 0.5 | 0.01849 | 0.0182 | 0.0185 |
| 2 | 1 | 0.0340 | 0.0339 | 0.0338 |
| 3 | 3 | 0.0906 | 0.0903 | 0.0906 |
| 4 | 5 | 0.1444 | 0.1456 | 0.1449 |
| 5 | 10 | 0.2465 | 0.2467 | 0.2469 |

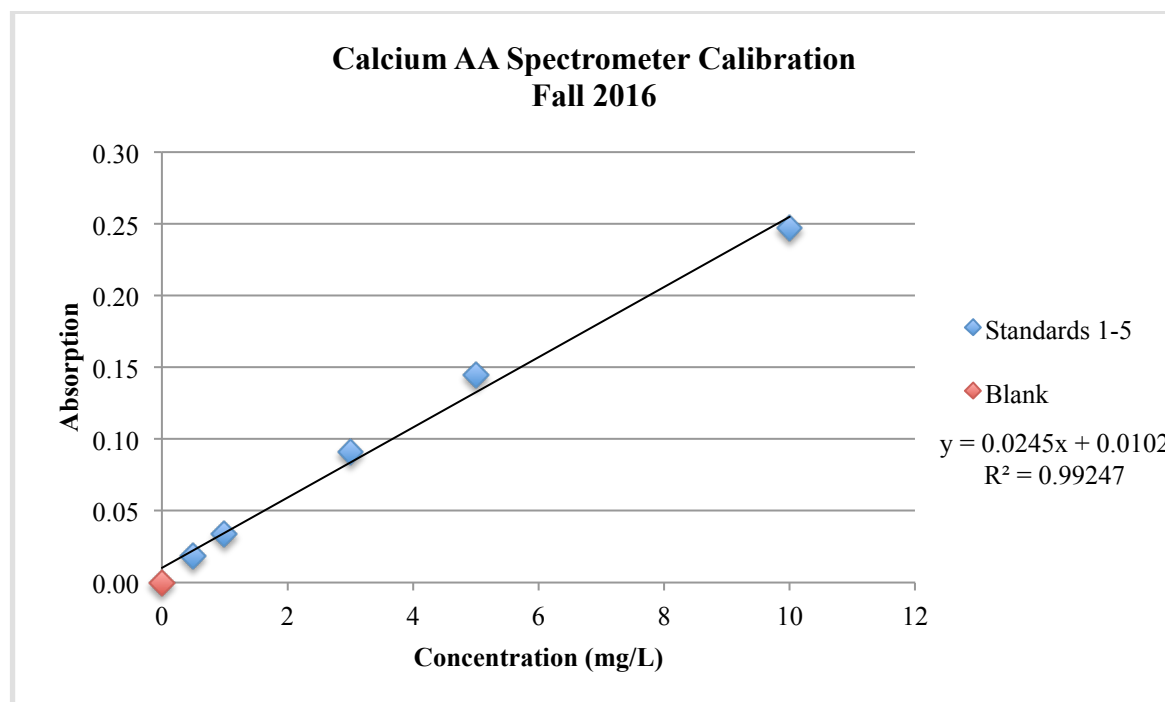

Calcium AA Spectrometer Results Fall 2016

| Sample ID | Sample Date | Absorption | Calculated Concentration (mg/L) | Dilution Factor | Corrected Concentration (mg/L) |
|------------------|--------------------|-------------------|--|------------------------|---------------------------------------|
| EM275 | 11/2/16 | 0.0338 | 0.9973 | 100 | 96.36 |
| IZ385 | 11/2/16 | 0.0412 | 1.2470 | 100 | 126.79 |
| IZ386 | 11/2/16 | 0.0403 | 1.2159 | 100 | 123.07 |
| SV631 | 11/7/16 | 0.0264 | 0.7603 | 100 | 66.14 |
| Well 11 | 11/3/16 | 0.0369 | 1.0990 | 100 | 109.01 |
| Well 11 | 2/28/17 | 0.0367 | 1.0934 | 100 | 108.33 |
| Well 12 | 11/3/16 | 0.0371 | 1.1071 | 100 | 109.99 |
| Well 12 | 2/28/17 | 0.0359 | 1.0680 | 100 | 105.26 |
| Well 13 | 11/17/16 | 0.0324 | 0.9543 | 100 | 90.84 |
| Well 13 | 2/28/17 | 0.0326 | 0.9592 | 100 | 91.48 |
| Hygeia Spring | 11/7/16 | 0.0261 | 0.7524 | 100 | 65.15 |
| Fox 0 | 11/7/16 | 0.0288 | 0.8375 | 100 | 75.96 |
| Fox 1 | 11/7/16 | 0.0262 | 0.7567 | 100 | 65.69 |
| Fox 2 | 11/7/16 | 0.0279 | 0.8105 | 100 | 72.54 |
| Fox 3 | 11/7/16 | 0.0262 | 0.7567 | 100 | 65.69 |
| Root River | 11/7/16 | 0.0277 | 0.8043 | 100 | 71.75 |
| Sussex Creek | 11/7/16 | 0.0316 | 0.9272 | 100 | 87.40 |
| Underwood Creek | 11/7/16 | 0.0307 | 0.8993 | 100 | 83.83 |
| Brookfield WWTP | 11/2/16 | 0.0340 | 1.0033 | 100 | 97.25 |
| Sussex WWTP | 11/3/16 | 0.0301 | 0.8814 | 100 | 81.56 |
| Waukesha WWTP | 11/3/16 | 0.0334 | 0.9846 | 100 | 94.73 |

Magnesium Standards AA Spectrometer Fall 2016

| Standard | Concentration (mg/L) | Absorption Start | Absorption Final | Absorption Average |
|----------|----------------------|------------------|------------------|--------------------|
| Blank | 0 | 0.0025 | 0.0027 | 0.0026 |
| 1 | 0.1 | 0.1371 | 0.1397 | 0.1383 |
| 2 | 0.25 | 0.3202 | 0.3201 | 0.3208 |
| 3 | 0.5 | 0.6117 | 0.6143 | 0.6100 |
| 4 | 1 | 1.0472 | 1.0564 | 1.0520 |

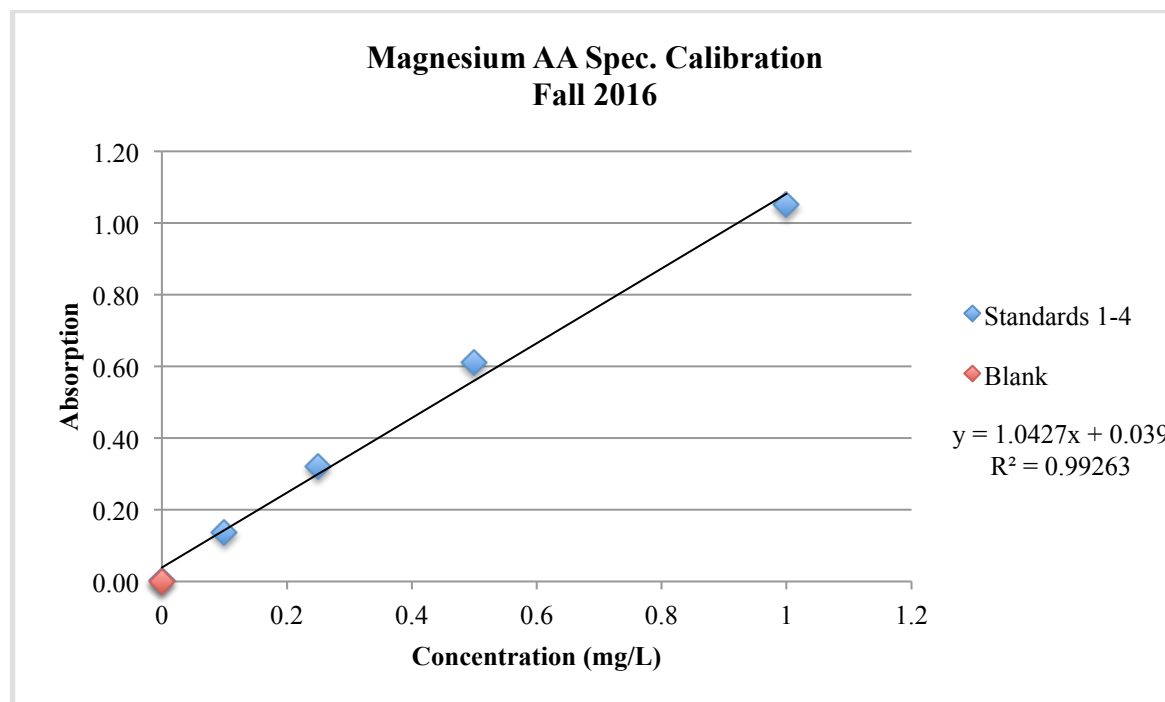

Magnesium AA Spectrometer Results Fall 2016

| Sample ID | Sample Date | Absorption | Calculated Concentration (mg/L) | Dilution Factor | Corrected Concentration (mg/L) |
|------------------|--------------------|-------------------|--|------------------------|---------------------------------------|
| EM275 | 11/2/16 | 0.5062 | 0.4054 | 100 | 44.81 |
| IZ385 | 11/2/16 | 0.6462 | 0.5312 | 100 | 58.24 |
| IZ386 | 11/2/16 | 0.6721 | 0.5564 | 100 | 60.72 |
| SV631 | 11/7/16 | 0.6822 | 0.5663 | 100 | 61.69 |
| Well 11 | 11/3/16 | 0.6242 | 0.5105 | 100 | 56.13 |
| Well 11 | 2/28/17 | 0.6171 | 0.5043 | 100 | 55.44 |
| Well 12 | 11/3/16 | 0.6252 | 0.5115 | 100 | 56.22 |
| Well 12 | 2/28/17 | 0.6163 | 0.5037 | 100 | 55.37 |
| Well 13 | 11/17/17 | 0.6329 | 0.5185 | 100 | 56.96 |
| Well 13 | 2/28/17 | 0.6385 | 0.5239 | 100 | 57.50 |
| Hygeia Spring | 11/7/16 | 0.4574 | 0.3621 | 100 | 40.13 |
| Fox 0 | 11/7/16 | 0.5002 | 0.4000 | 100 | 44.25 |
| Fox 1 | 11/7/16 | 0.4722 | 0.3748 | 100 | 41.55 |
| Fox 2 | 11/7/16 | 0.4839 | 0.3854 | 100 | 42.68 |
| Fox 3 | 11/7/16 | 0.4624 | 0.3663 | 100 | 40.61 |
| Root River | 11/7/16 | 0.4913 | 0.3920 | 100 | 43.38 |
| Sussex Creek | 11/7/16 | 0.5335 | 0.4300 | 100 | 47.43 |
| Underwood Creek | 11/7/16 | 0.5774 | 0.4697 | 100 | 51.64 |
| Brookfield WWTP | 11/2/16 | 0.5421 | 0.4377 | 100 | 48.25 |
| Sussex WWTP | 11/3/16 | 0.4874 | 0.3885 | 100 | 43.01 |
| Waukesha WWTP | 11/3/16 | 0.4987 | 0.3987 | 100 | 44.10 |

Sodium Standards AA Spectrometer Fall 2016

| Standard | Concentration (mg/L) | Absorption Start | Absorption Final | Absorption Average |
|----------|----------------------|------------------|------------------|--------------------|
| Blank | 0 | 0.0196 | 0.0234 | 0.0218 |
| 1 | 0.1 | 0.0840 | 0.0848 | 0.0838 |
| 2 | 0.25 | 0.1664 | 0.1676 | 0.1668 |
| 3 | 0.5 | 0.3066 | 0.3080 | 0.3085 |
| 4 | 1 | 0.5498 | 0.5450 | 0.5473 |
| 5 | 2 | 0.9133 | 0.9133 | 0.9062 |

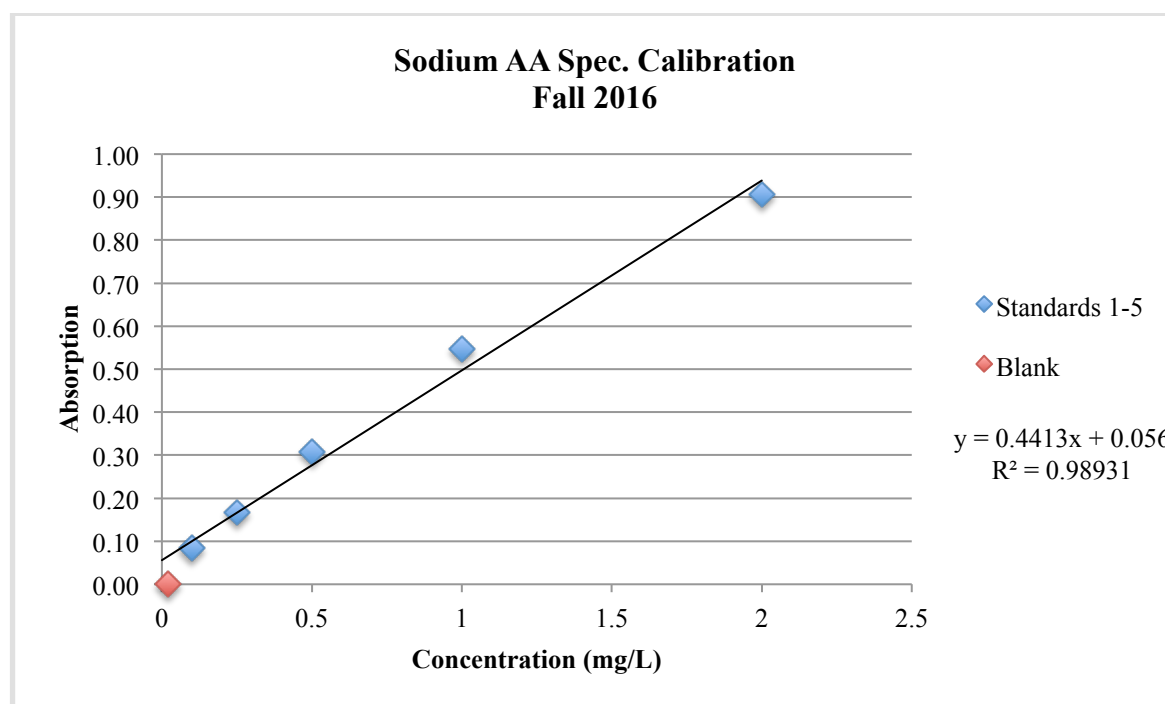

Sodium AA Spectrometer Results Fall 2016

| Sample ID | Sample Date | Absorption | Calculated Concentration (mg/L) | Dilution Factor | Corrected Concentration (mg/L) |
|------------------|--------------------|-------------------|--|------------------------|---------------------------------------|
| EM275 | 11/2/16 | 0.1101 | 0.1446 | 100 | 12.27 |
| IZ385 | 11/2/16 | 0.6198 | 1.1614 | 100 | 127.78 |
| IZ386 | 11/2/16 | 0.4581 | 0.7960 | 100 | 91.13 |
| SV631 | 11/7/16 | 0.1352 | 0.1895 | 100 | 17.96 |
| Well 11 | 11/3/16 | 0.5487 | 1.0000 | 100 | 111.65 |
| Well 11 | 2/28/17 | 0.5346 | 0.9686 | 100 | 108.45 |
| Well 12 | 11/3/16 | 0.4506 | 0.7792 | 100 | 89.43 |
| Well 12 | 2/28/17 | 0.4284 | 0.7296 | 100 | 84.39 |
| Well 13 | 11/17/17 | 0.2425 | 0.3817 | 100 | 42.47 |
| Well 13 | 2/28/17 | 0.2335 | 0.3659 | 100 | 40.24 |
| Hygeia Spring | 11/7/16 | 0.3404 | 0.5583 | 100 | 64.45 |
| Fox 0 | 11/7/16 | 0.3428 | 0.5629 | 100 | 65.00 |
| Fox 1 | 11/7/16 | 0.5262 | 0.9494 | 100 | 106.56 |
| Fox 2 | 11/7/16 | 0.6118 | 1.1420 | 100 | 125.95 |
| Fox 3 | 11/7/16 | 0.3969 | 0.6679 | 100 | 77.25 |
| Root River | 11/7/16 | 0.5185 | 0.9317 | 100 | 104.81 |
| Sussex Creek | 11/7/16 | 0.7376 | 1.4555 | 100 | 154.46 |
| Underwood Creek | 11/7/16 | 0.8348 | 1.7606 | 100 | 176.48 |
| Brookfield WWTP | 11/2/16 | 0.1503 | 0.2180 | 100 | 213.69 |
| Sussex WWTP | 11/3/16 | 0.1316 | 0.1827 | 100 | 171.33 |
| Waukesha WWTP | 11/3/16 | 0.1394 | 0.1975 | 100 | 189.16 |

| Potassium Standards AA Spectrometer Fall 2016 | | | | |
|---|----------------------|------------------|------------------|--------------------|
| Standard | Concentration (mg/L) | Absorption Start | Absorption Final | Absorption Average |
| Blank | 0 | 0.0121 | 0.0134 | 0.0123 |
| 1 | 0.25 | 0.1579 | 0.1587 | 0.1573 |
| 2 | 0.5 | 0.2800 | 0.2824 | 0.2806 |
| 3 | 1 | 0.4922 | 0.4913 | 0.4893 |
| 4 | 2 | 0.8536 | 0.8440 | 0.8558 |

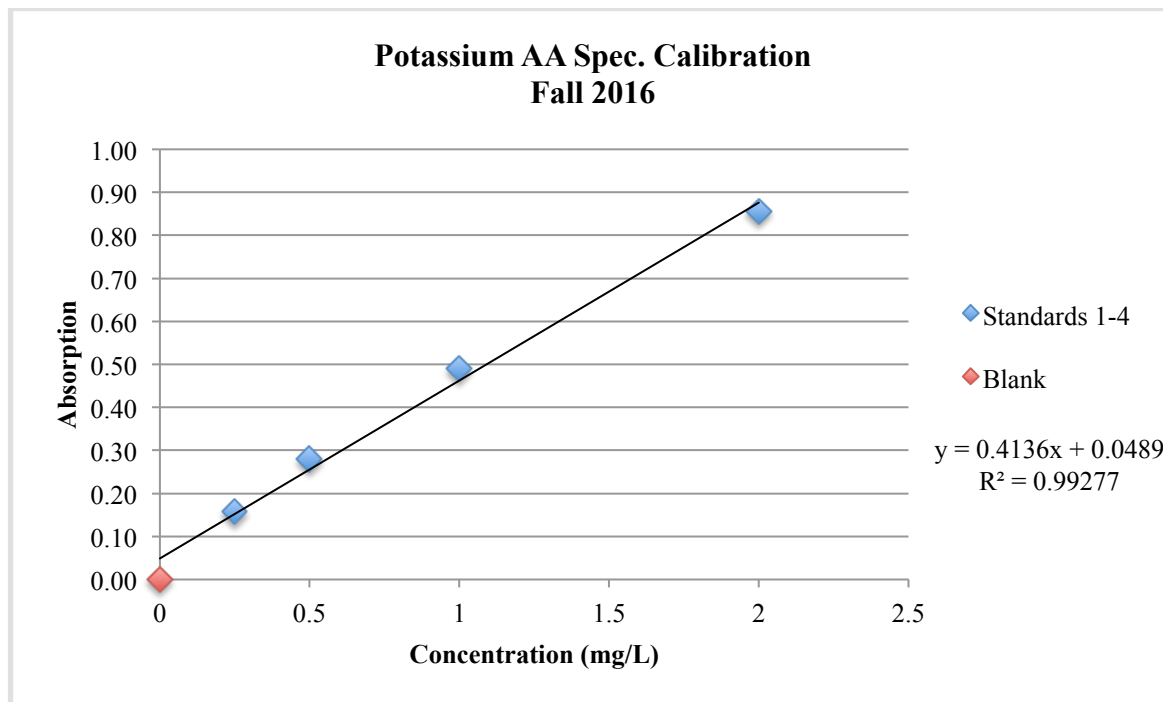

Potassium AA Spectrometer Results Fall 2016

| Sample ID | Sample Date | Absorption | Calculated Concentration (mg/L) | Dilution Factor | Corrected Concentration (mg/L) |
|------------------|--------------------|-------------------|--|------------------------|---------------------------------------|
| EM275 | 11/2/16 | 0.1279 | 0.1992 | 10 | 1.91 |
| IZ385 | 11/2/16 | 0.1662 | 0.2654 | 10 | 2.84 |
| IZ386 | 11/2/16 | 0.1519 | 0.2406 | 10 | 2.49 |
| SV631 | 11/7/16 | 0.0822 | 0.1205 | 10 | 0.81 |
| Well 11 | 11/3/16 | 0.1568 | 0.2491 | 10 | 2.61 |
| Well 11 | 2/28/17 | 0.1184 | 0.1829 | 10 | 1.68 |
| Well 12 | 11/3/16 | 0.1494 | 0.2363 | 10 | 2.43 |
| Well 12 | 2/28/17 | 0.1416 | 0.2228 | 10 | 2.24 |
| Well 13 | 11/17/17 | 0.1181 | 0.1394 | 10 | 1.67 |
| Well 13 | 2/28/17 | 0.0932 | 0.1823 | 10 | 1.07 |
| Hygeia Spring | 11/7/16 | 0.1125 | 0.1726 | 10 | 1.54 |
| Fox 0 | 11/7/16 | 0.1519 | 0.2405 | 10 | 2.49 |
| Fox 1 | 11/7/16 | 0.1581 | 0.2409 | 10 | 2.64 |
| Fox 2 | 11/7/16 | 0.1901 | 0.3106 | 10 | 3.42 |
| Fox 3 | 11/7/16 | 0.1504 | 0.2380 | 10 | 2.45 |
| Root River | 11/7/16 | 0.1429 | 0.2251 | 10 | 2.27 |
| Sussex Creek | 11/7/16 | 0.2998 | 0.5378 | 10 | 6.07 |
| Underwood Creek | 11/7/16 | 0.6385 | 1.3604 | 10 | 14.26 |
| Brookfield WWTP | 11/2/16 | 0.4177 | 0.8080 | 10 | 8.92 |
| Sussex WWTP | 11/3/16 | 0.4182 | 0.8092 | 10 | 8.93 |
| Waukesha WWTP | 11/3/16 | 0.5244 | 1.0785 | 10 | 11.50 |

Calcium Standards AA Spectrometer Fall 2017

| Standard | Concentration (mg/L) | Absorption Start | Absorption Final | Absorption Average |
|----------|----------------------|------------------|------------------|--------------------|
| Blank | 0 | 0.0045 | 0.0044 | 0.0045 |
| 1 | 0.5 | 0.0257 | 0.0258 | 0.0258 |
| 2 | 1 | 0.0473 | 0.0474 | 0.0476 |
| 3 | 3 | 0.1292 | 0.1291 | 0.1290 |
| 4 | 5 | 0.2016 | 0.2040 | 0.2030 |
| 5 | 10 | 0.3683 | 0.3674 | 0.3689 |

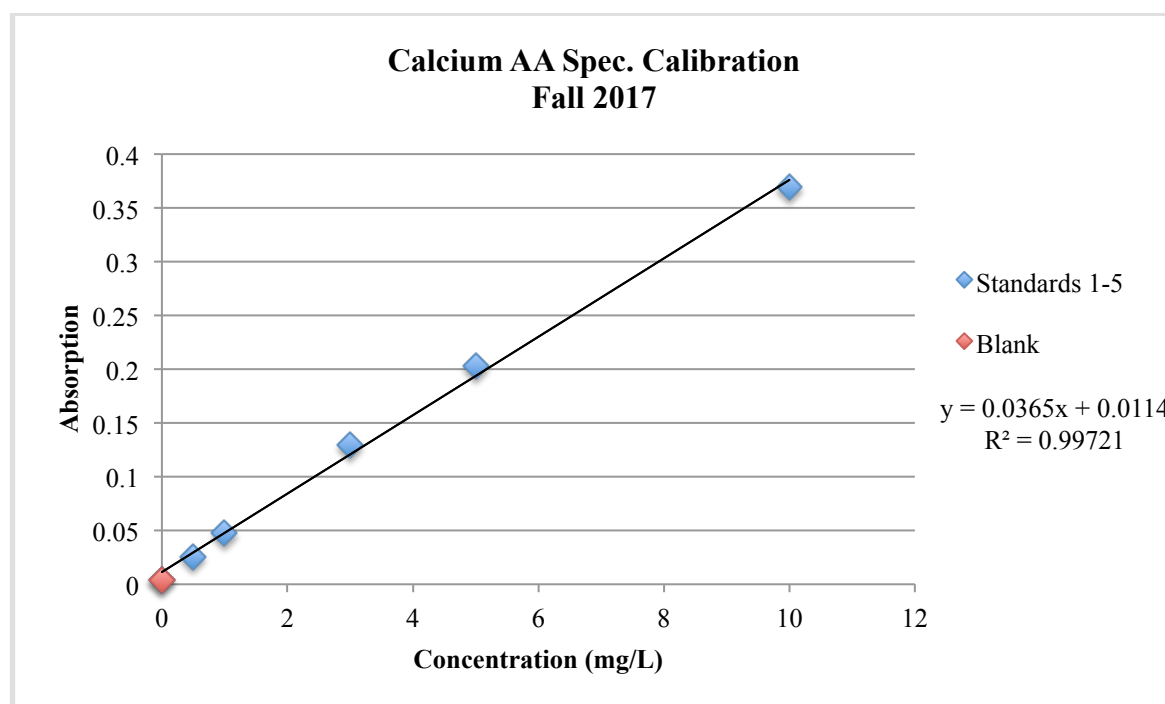

Calcium AA Spectrometer Results Fall 2017

| Sample ID | Sample Date | Absorption | Calculated Concentration (mg/L) | Dilution Factor | Corrected Concentration (mg/L) |
|------------------|--------------------|-------------------|--|------------------------|---------------------------------------|
| EM275 | 8/25/17 | 0.0461 | 0.9665 | 100 | 95.31 |
| IZ385 | 8/25/17 | 0.0531 | 1.1282 | 100 | 114.48 |
| SV631 | 9/15/17 | 0.0038 | 0.8011 | 100 | 75.34 |
| Well 11 | 6/29/17 | 0.0543 | 1.1566 | 100 | 117.75 |
| Well 11 | 7/27/17 | 0.0254 | 0.4872 | 100 | 38.50 |
| Well 12 | 6/29/17 | 0.0509 | 1.0760 | 100 | 108.44 |
| Well 12 | 7/27/17 | 0.0291 | 0.5765 | 100 | 48.69 |
| Well 13 | 6/29/17 | 0.0476 | 0.9996 | 100 | 99.34 |
| Well 13 | 7/27/17 | 0.0339 | 0.6899 | 100 | 61.86 |
| Hygeia Spring | 8/20/17 | 0.0392 | 0.8086 | 100 | 76.24 |
| Fox 0 | 8/5/17 | 0.0345 | 0.7021 | 100 | 63.52 |
| Fox 1 | 8/19/17 | 0.0385 | 0.7925 | 100 | 74.30 |
| Fox 2 | 8/20/17 | 0.0417 | 0.8663 | 100 | 83.20 |
| Fox 3 | 8/20/17 | 0.0363 | 0.7437 | 100 | 68.44 |
| Root River | 8/31/17 | 0.0387 | 0.7967 | 100 | 74.81 |
| Sussex Creek | 8/5/17 | 0.0418 | 0.8686 | 100 | 83.48 |
| Underwood Creek | 8/20/17 | 0.0453 | 0.9482 | 100 | 93.09 |
| Brookfield WWTP | 8/24/17 | 0.0518 | 1.0973 | 100 | 110.91 |
| Sussex WWTP | 8/31/17 | 0.0456 | 0.9547 | 100 | 93.88 |
| Waukesha WWTP | 8/31/17 | 0.0474 | 0.9955 | 100 | 98.82 |

Magnesium Standards AA Spectrometer Fall 2017

| Standard | Concentration (mg/L) | Absorption Start | Absorption Final | Absorption Average |
|----------|----------------------|------------------|------------------|--------------------|
| Blank | 0 | 0.0038 | 0.0042 | 0.0040 |
| 1 | 0.1 | 0.1131 | 0.1150 | 0.1146 |
| 2 | 0.25 | 0.2826 | 0.2816 | 0.2831 |
| 3 | 0.5 | 0.5215 | 0.5240 | 0.5236 |
| 4 | 1 | 0.9124 | 0.9233 | 0.9193 |

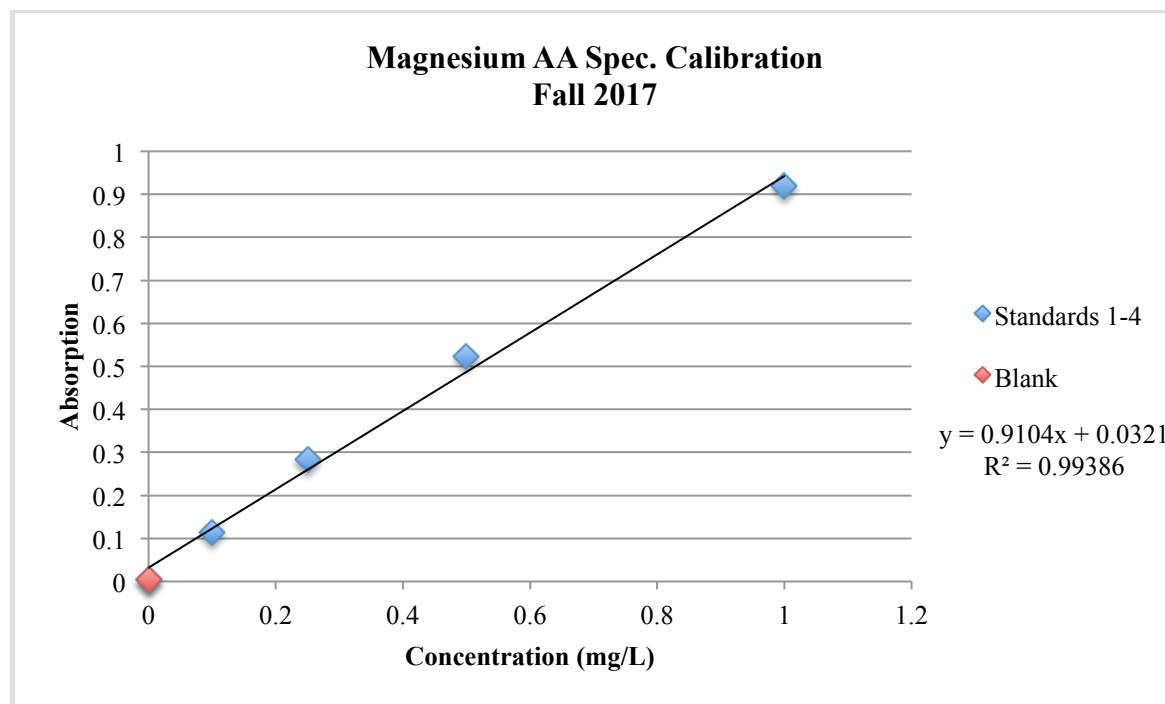

Magnesium AA Spectrometer Results Fall 2017

| Sample ID | Sample Date | Absorption | Calculated Concentration (mg/L) | Dilution Factor | Corrected Concentration (mg/L) |
|------------------|--------------------|-------------------|--|------------------------|---------------------------------------|
| EM275 | 8/25/17 | 0.4556 | 0.4235 | 100 | 46.13 |
| IZ385 | 8/25/17 | 0.5578 | 0.5346 | 100 | 57.74 |
| SV631 | 9/15/17 | 0.5795 | 0.5586 | 100 | 60.12 |
| Well 11 | 6/29/17 | 0.5522 | 0.5284 | 100 | 57.13 |
| Well 11 | 7/27/17 | 0.5052 | 0.4918 | 100 | 51.96 |
| Well 12 | 6/29/17 | 0.5384 | 0.5136 | 100 | 51.67 |
| Well 12 | 7/27/17 | 0.4771 | 0.4618 | 100 | 48.88 |
| Well 13 | 6/29/17 | 0.5592 | 0.5361 | 100 | 57.90 |
| Well 13 | 7/27/17 | 0.4992 | 0.4854 | 100 | 51.30 |
| Hygeia Spring | 8/20/17 | 0.4111 | 0.3748 | 100 | 41.62 |
| Fox 0 | 8/5/17 | 0.4073 | 0.3707 | 100 | 41.21 |
| Fox 1 | 8/19/17 | 0.4710 | 0.4405 | 100 | 48.20 |
| Fox 2 | 8/20/17 | 0.4819 | 0.4525 | 100 | 49.40 |
| Fox 3 | 8/20/17 | 0.4422 | 0.4088 | 100 | 45.04 |
| Root River | 8/31/17 | 0.4670 | 0.4362 | 100 | 47.77 |
| Sussex Creek | 8/5/17 | 0.4691 | 0.4384 | 100 | 48.00 |
| Underwood Creek | 8/20/17 | 0.5375 | 0.5125 | 100 | 55.51 |
| Brookfield WWTP | 8/24/17 | 0.5202 | 0.4955 | 100 | 53.61 |
| Sussex WWTP | 8/31/17 | 0.4699 | 0.4393 | 100 | 48.09 |
| Waukesha WWTP | 8/31/17 | 0.4412 | 0.4077 | 100 | 44.93 |

Sodium Standards AA Spectrometer Fall 2017

| Standard | Concentration (mg/L) | Absorption Start | Absorption Final | Absorption Average |
|----------|----------------------|------------------|------------------|--------------------|
| Blank | 0 | 0.0049 | 0.0047 | 0.0047 |
| 1 | 0.1 | 0.0604 | 0.0610 | 0.0616 |
| 2 | 0.25 | 0.1416 | 0.1359 | 0.1395 |
| 3 | 0.5 | 0.2609 | 0.2612 | 0.2595 |
| 4 | 1 | 0.5019 | 0.4979 | 0.4997 |
| 5 | 2 | 0.8635 | 0.8536 | 0.8564 |

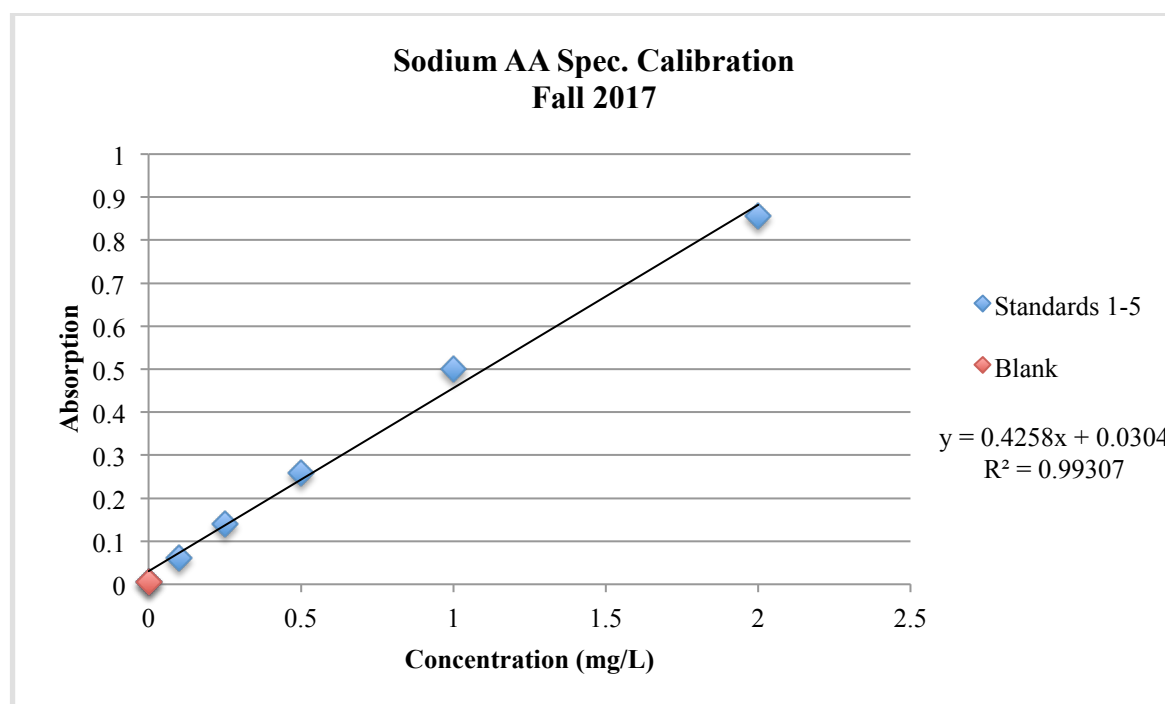

Sodium AA Spectrometer Results Fall 2017

| Sample ID | Sample Date | Absorption | Calculated Concentration (mg/L) | Dilution Factor | Corrected Concentration (mg/L) |
|------------------|--------------------|-------------------|--|------------------------|---------------------------------------|
| EM275 | 8/25/17 | 0.1080 | 0.1865 | 100 | 18.24 |
| IZ385 | 8/25/17 | 0.4981 | 0.9963 | 100 | 109.86 |
| SV631 | 9/15/17 | 0.1423 | 0.2548 | 100 | 26.29 |
| Well 11 | 6/29/17 | 0.4879 | 0.9740 | 100 | 107.46 |
| Well 11 | 7/27/17 | 0.4429 | 0.9450 | 100 | 98.37 |
| Well 12 | 6/29/17 | 0.4013 | 0.7888 | 100 | 87.11 |
| Well 12 | 7/27/17 | 0.3719 | 0.7714 | 100 | 80.21 |
| Well 13 | 6/29/17 | 0.2056 | 0.3808 | 100 | 41.15 |
| Well 13 | 7/27/17 | 0.1887 | 0.3708 | 100 | 37.18 |
| Hygeia Spring | 8/20/17 | 0.3283 | 0.6383 | 100 | 69.97 |
| Fox 0 | 8/5/17 | 0.2916 | 0.5637 | 100 | 61.34 |
| Fox 1 | 8/19/17 | 0.6969 | 1.4885 | 100 | 156.52 |
| Fox 2 | 8/20/17 | 0.6846 | 1.4505 | 100 | 153.65 |
| Fox 3 | 8/20/17 | 0.4221 | 0.8330 | 100 | 91.98 |
| Root River | 8/31/17 | 0.6233 | 1.2933 | 100 | 139.25 |
| Sussex Creek | 8/5/17 | 0.5271 | 1.0576 | 100 | 116.64 |
| Underwood Creek | 8/20/17 | 0.7825 | 1.7558 | 100 | 176.63 |
| Brookfield WWTP | 8/24/17 | 0.1852 | 0.3309 | 100 | 36.35 |
| Sussex WWTP | 8/31/17 | 0.1656 | 0.3003 | 100 | 31.76 |
| Waukesha WWTP | 8/31/17 | 0.1705 | 0.3099 | 100 | 32.90 |

| Potassium Standards AA Spectrometer Fall 2017 | | | | |
|---|----------------------|------------------|------------------|--------------------|
| Standard | Concentration (mg/L) | Absorption Start | Absorption Final | Absorption Average |
| Blank | 0 | 0.0075 | 0.0068 | 0.0057 |
| 1 | 0.25 | 0.1020 | 0.1068 | 0.1044 |
| 2 | 0.5 | 0.2395 | 0.2397 | 0.2381 |
| 3 | 1 | 0.4143 | 0.4221 | 0.4207 |
| 4 | 2 | 0.7555 | 0.7653 | 0.7611 |

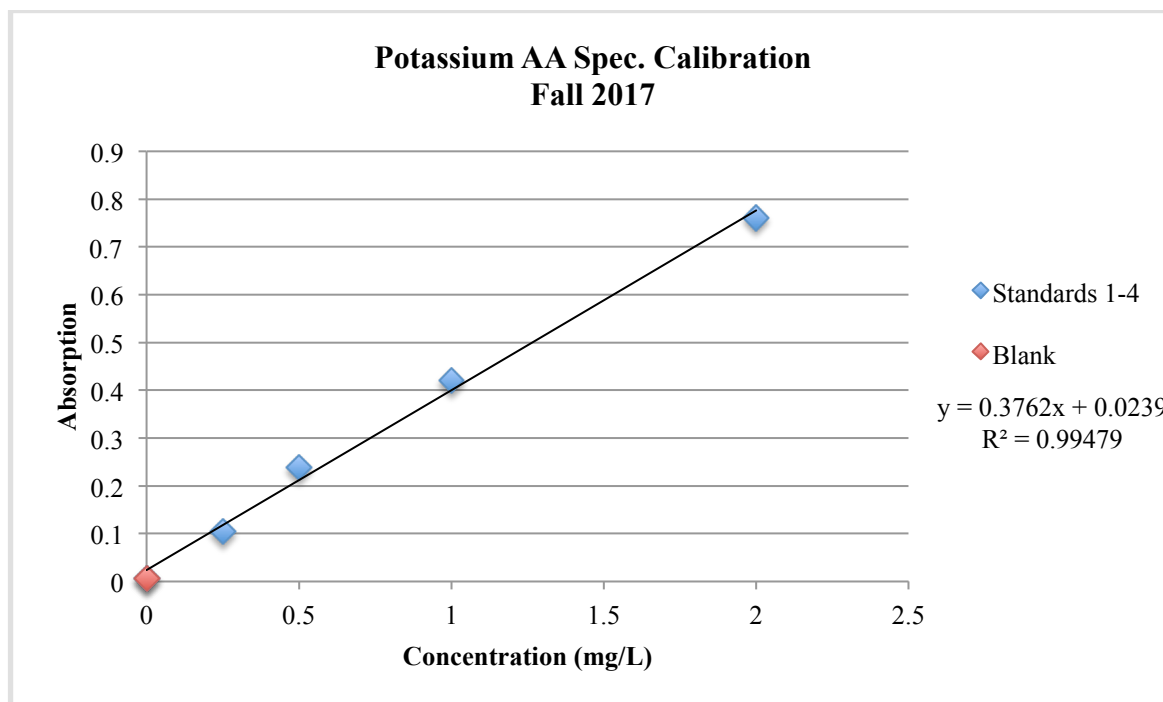

Potassium AA Spectrometer Results Fall 2017

| Sample ID | Sample Date | Absorption | Calculated Concentration (mg/L) | Dilution Factor | Corrected Concentration (mg/L) |
|------------------|--------------------|-------------------|--|------------------------|---------------------------------------|
| EM275 | 8/25/17 | 0.1063 | 0.2164 | 10 | 2.19 |
| IZ385 | 8/25/17 | 0.1488 | 0.3077 | 10 | 3.32 |
| SV631 | 9/15/17 | 0.0813 | 0.1626 | 10 | 1.52 |
| Well 11 | 6/29/17 | 0.1414 | 0.2919 | 10 | 3.12 |
| Well 11 | 7/27/17 | 0.5145 | 0.3447 | 10 | 3.37 |
| Well 12 | 6/29/17 | 0.1327 | 0.2731 | 10 | 2.89 |
| Well 12 | 7/27/17 | 0.1508 | 0.3319 | 10 | 3.12 |
| Well 13 | 6/29/17 | 0.1097 | 0.0237 | 10 | 2.82 |
| Well 13 | 7/27/17 | 0.1176 | 0.2732 | 10 | 2.49 |
| Hygeia Spring | 8/20/17 | 0.1202 | 0.2462 | 10 | 2.56 |
| Fox 0 | 8/5/17 | 0.1225 | 0.2510 | 10 | 2.62 |
| Fox 1 | 8/19/17 | 0.2130 | 0.4458 | 10 | 5.03 |
| Fox 2 | 8/20/17 | 0.2212 | 0.4633 | 10 | 5.24 |
| Fox 3 | 8/20/17 | 0.1368 | 0.2818 | 10 | 3.00 |
| Root River | 8/31/17 | 0.1871 | 0.3900 | 10 | 4.34 |
| Sussex Creek | 8/5/17 | 0.2223 | 0.4658 | 10 | 5.27 |
| Underwood Creek | 8/20/17 | 0.2796 | 0.5982 | 10 | 6.80 |
| Brookfield WWTP | 8/24/17 | 0.4605 | 1.1016 | 10 | 11.60 |
| Sussex WWTP | 8/31/17 | 0.4843 | 1.1659 | 10 | 12.24 |
| Waukesha WWTP | 8/31/17 | 0.1202 | 1.2484 | 10 | 2.56 |

Calcium Standards AA Spectrometer Winter 2017

| Standard | Concentration (mg/L) | Absorption Start | Absorption Final | Absorption Average |
|----------|----------------------|------------------|------------------|--------------------|
| Blank | 0 | 0.0032 | 0.0028 | 0.0031 |
| 1 | 0.5 | 0.0261 | 0.026 | 0.0503 |
| 2 | 1 | 0.0503 | 0.0501 | 0.0503 |
| 3 | 3 | 0.1393 | 0.1388 | 0.1392 |

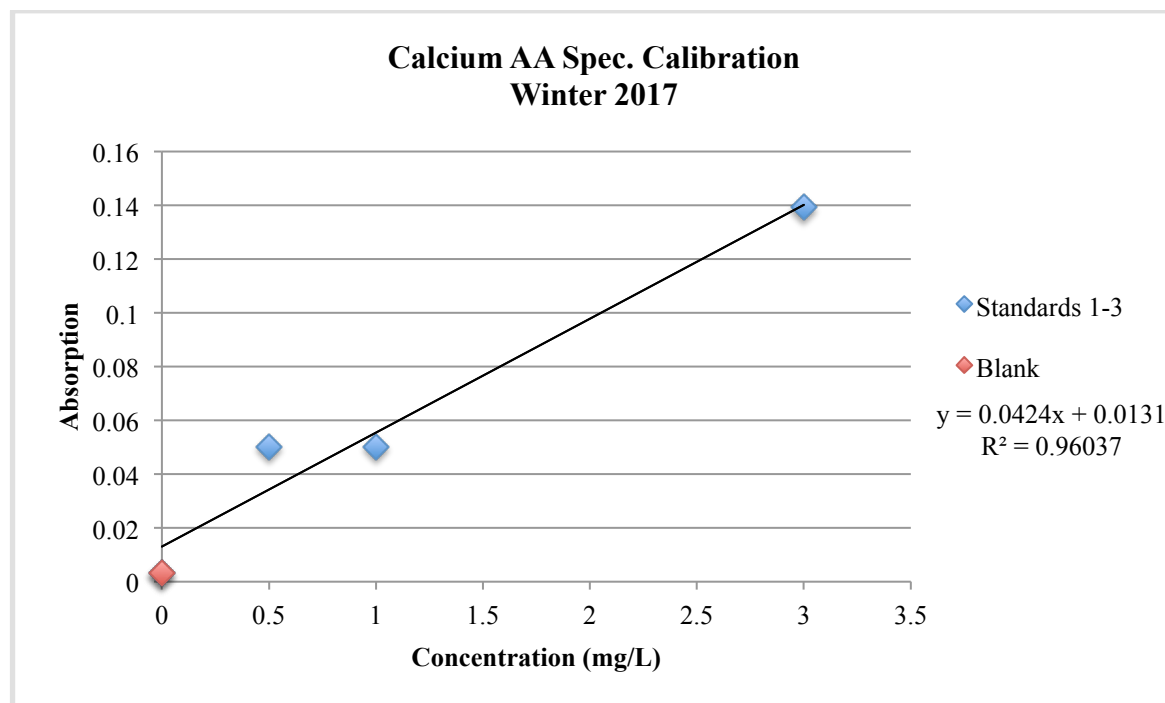

Calcium AA Spectrometer Results Winter 2017

| Sample ID | Sample Date | Absorption | Calculated Concentration (mg/L) | Dilution Factor | Corrected Concentration (mg/L) |
|------------------|--------------------|-------------------|--|------------------------|---------------------------------------|
| Well 11 | 11/8/17 | 0.0566 | 1.1347 | 100 | 102.59 |
| Well 11 | 11/29/17 | 0.0534 | 1.0645 | 100 | 95.05 |
| Well 11 | 12/1/17 | 0.0531 | 1.0594 | 100 | 94.34 |
| Well 11 | 1/26/18 | 0.0535 | 1.0682 | 100 | 95.28 |
| Well 12 | 11/8/17 | 0.0532 | 1.0603 | 100 | 94.58 |
| Well 12 | 11/29/17 | 0.0519 | 1.0342 | 100 | 91.51 |
| Well 12 | 12/1/17 | 0.0523 | 1.0416 | 100 | 92.45 |
| Well 12 | 1/26/18 | 0.0523 | 1.0421 | 100 | 92.45 |
| Well 13 | 11/8/17 | 0.0531 | 1.058 | 100 | 94.34 |
| Well 13 | 11/29/17 | 0.0467 | 0.9299 | 100 | 79.25 |
| Well 13 | 12/1/17 | 0.0474 | 0.9433 | 100 | 80.90 |
| Well 13 | 1/26/18 | 0.0465 | 0.9251 | 100 | 78.77 |

Magnesium Standards AA Spectrometer Winter 2017

| Standard | Concentration (mg/L) | Absorption Start | Absorption Final | Absorption Average |
|----------|----------------------|------------------|------------------|--------------------|
| Blank | 0 | 0.0032 | 0.0028 | 0.0029 |
| 1 | 0.1 | 0.1189 | 0.1183 | 0.1184 |
| 2 | 0.25 | 0.2849 | 0.2833 | 0.2826 |
| 3 | 0.5 | 0.5482 | 0.5422 | 0.5460 |
| 4 | 1 | 0.9532 | 0.9382 | 0.9414 |

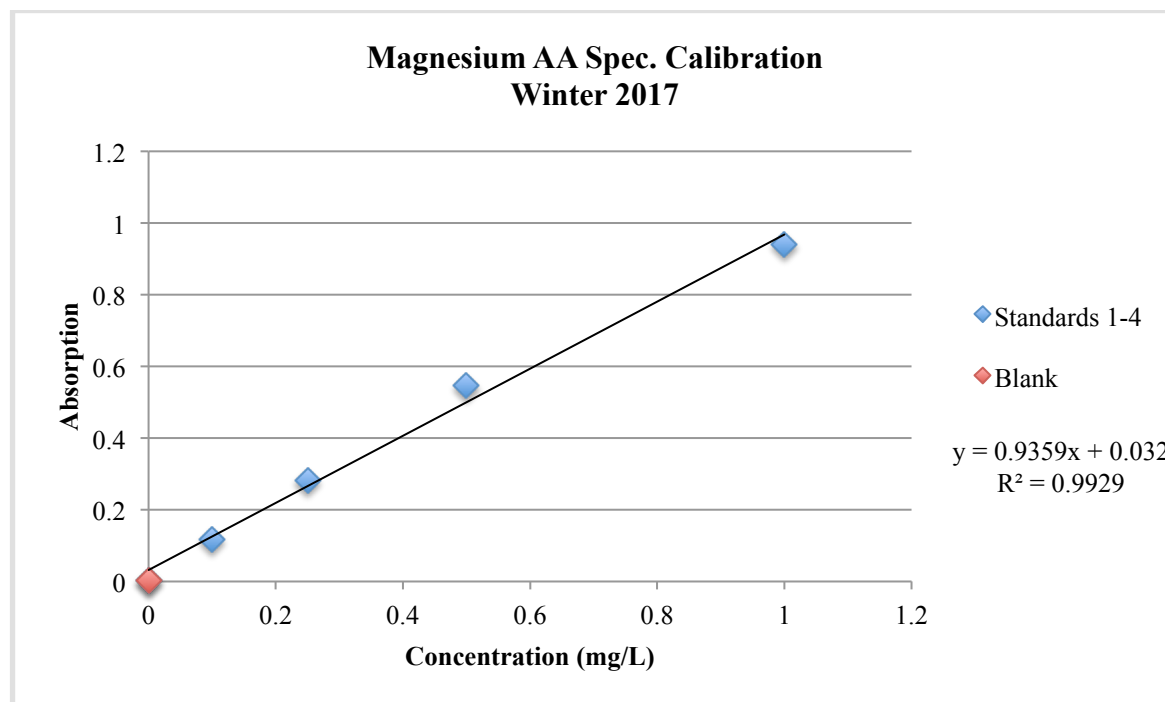

Magnesium AA Spectrometer Results Winter 2017

| Sample ID | Sample Date | Absorption | Calculated Concentration (mg/L) | Dilution Factor | Corrected Concentration (mg/L) |
|------------------|--------------------|-------------------|--|------------------------|---------------------------------------|
| Well 11 | 11/8/17 | 0.5612 | 0.5131 | 100 | 56.54 |
| Well 11 | 11/29/17 | 0.5431 | 0.4969 | 100 | 54.61 |
| Well 11 | 12/1/17 | 0.54 | 0.4937 | 100 | 54.28 |
| Well 11 | 1/26/18 | 0.5427 | 0.4965 | 100 | 54.57 |
| Well 12 | 11/8/17 | 0.5284 | 0.4823 | 100 | 53.04 |
| Well 12 | 11/29/17 | 0.5299 | 0.4838 | 100 | 53.20 |
| Well 12 | 12/1/17 | 0.5312 | 0.485 | 100 | 53.34 |
| Well 12 | 1/26/18 | 0.5353 | 0.4891 | 100 | 53.78 |
| Well 13 | 11/8/17 | 0.6336 | 0.5918 | 100 | 64.28 |
| Well 13 | 11/29/17 | 0.5454 | 0.4992 | 100 | 54.86 |
| Well 13 | 12/1/17 | 0.5521 | 0.5041 | 100 | 55.57 |
| Well 13 | 1/26/18 | 0.5517 | 0.5038 | 100 | 55.53 |

| Sodium Standards AA Spectrometer Winter 2017 | | | | |
|--|----------------------|------------------|------------------|--------------------|
| Standard | Concentration (mg/L) | Absorption Start | Absorption Final | Absorption Average |
| Blank | 0 | 0 | 0.0001 | 0.0000 |
| 1 | 0.1 | 0.0591 | 0.0584 | 0.0586 |
| 2 | 0.25 | 0.136 | 0.1407 | 0.1390 |
| 3 | 0.5 | 0.2695 | 0.2667 | 0.2683 |
| 4 | 1 | 0.5331 | 0.5194 | 0.5241 |

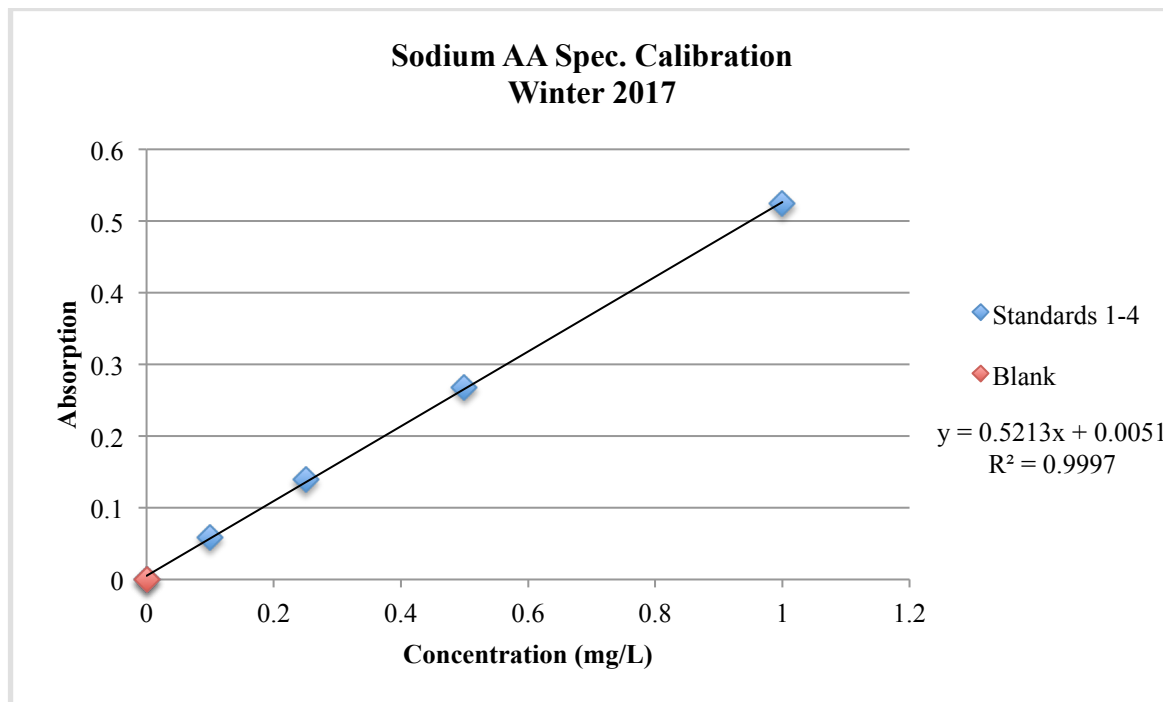

Sodium AA Spectrometer Results Winter 2017

| Sample ID | Sample Date | Absorption | Calculated Concentration (mg/L) | Dilution Factor | Corrected Concentration (mg/L) |
|------------------|--------------------|-------------------|--|------------------------|---------------------------------------|
| Well 11 | 11/8/17 | 0.5176 | 0.9865 | 100 | 98.31 |
| Well 11 | 11/29/17 | 0.5041 | 0.9592 | 100 | 95.72 |
| Well 11 | 12/1/17 | 0.531 | 1.01 | 100 | 100.88 |
| Well 11 | 1/26/18 | 0.5307 | 1.0095 | 100 | 100.82 |
| Well 12 | 11/8/17 | 0.4155 | 0.7823 | 100 | 78.73 |
| Well 12 | 11/29/17 | 0.4126 | 0.7765 | 100 | 78.17 |
| Well 12 | 12/1/17 | 0.417 | 0.7853 | 100 | 79.01 |
| Well 12 | 1/26/18 | 0.4226 | 0.7964 | 100 | 80.09 |
| Well 13 | 11/8/17 | 0.2222 | 0.4072 | 100 | 41.65 |
| Well 13 | 11/29/17 | 0.2108 | 0.3845 | 100 | 39.46 |
| Well 13 | 12/1/17 | 0.2112 | 0.3818 | 100 | 39.54 |
| Well 13 | 1/26/18 | 0.21 | 0.3828 | 100 | 39.31 |

Potassium Standards AA Spectrometer Winter 2017

| Standard | Concentration (mg/L) | Absorption Start | Absorption Final | Absorption Average |
|----------|----------------------|------------------|------------------|--------------------|
| Blank | 0 | -0.0056 | -0.002 | -0.0006 |
| 1 | 0.25 | 0.1052 | 0.1049 | 0.1087 |
| 2 | 0.5 | 0.2395 | 0.2473 | 0.2401 |
| 3 | 1 | 0.4412 | 0.4413 | 0.4417 |

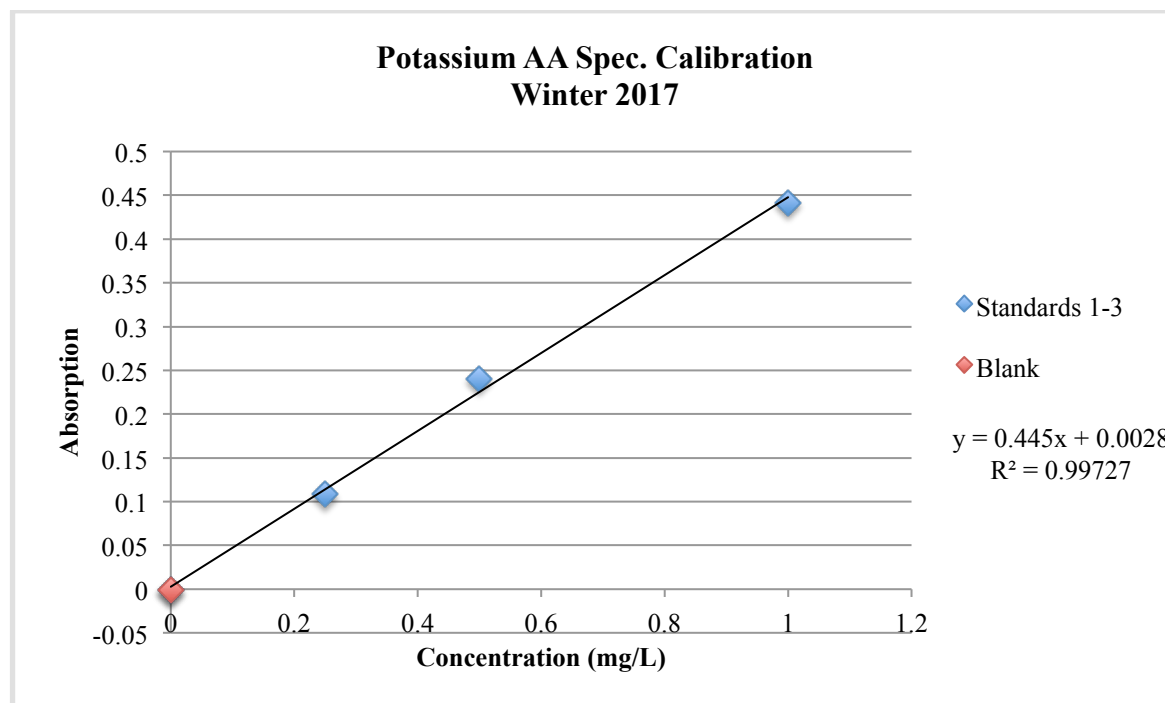

Potassium AA Spectrometer Results Winter 2017

| Sample ID | Sample Date | Absorption | Calculated Concentration (mg/L) | Dilution Factor | Corrected Concentration (mg/L) |
|------------------|--------------------|-------------------|--|------------------------|---------------------------------------|
| Well 11 | 11/8/17 | 0.1662 | 0.3709 | 10 | 3.67 |
| Well 11 | 11/29/17 | 0.1766 | 0.3915 | 10 | 3.91 |
| Well 11 | 12/1/17 | 0.1682 | 0.3749 | 10 | 3.72 |
| Well 11 | 1/26/18 | 0.1637 | 0.3656 | 10 | 3.62 |
| Well 12 | 11/8/17 | 0.1576 | 0.3532 | 10 | 3.48 |
| Well 12 | 11/29/17 | 0.1521 | 0.3418 | 10 | 3.36 |
| Well 12 | 12/1/17 | 0.1538 | 0.3453 | 10 | 3.39 |
| Well 12 | 1/26/18 | 0.1588 | 0.3556 | 10 | 3.51 |
| Well 13 | 11/8/17 | 0.1411 | 0.3191 | 10 | 3.11 |
| Well 13 | 11/29/17 | 0.1298 | 0.2958 | 10 | 2.85 |
| Well 13 | 12/1/17 | 0.1309 | 0.298 | 10 | 2.88 |
| Well 13 | 1/26/18 | 0.1205 | 0.2763 | 10 | 2.64 |

Ion Chromatography with Calibration Curves for Major Ions

| Chloride Standards IC Fall 2016 | | |
|---------------------------------|----------------------|---|
| Standard | Concentration (mg/L) | Area ($\mu\text{S} \cdot \text{min}$) |
| 1 | 50 | 10.0989 |
| 2 | 100 | 27.3091 |
| 3 | 200 | 49.6441 |
| 4 | 300 | 90.0969 |

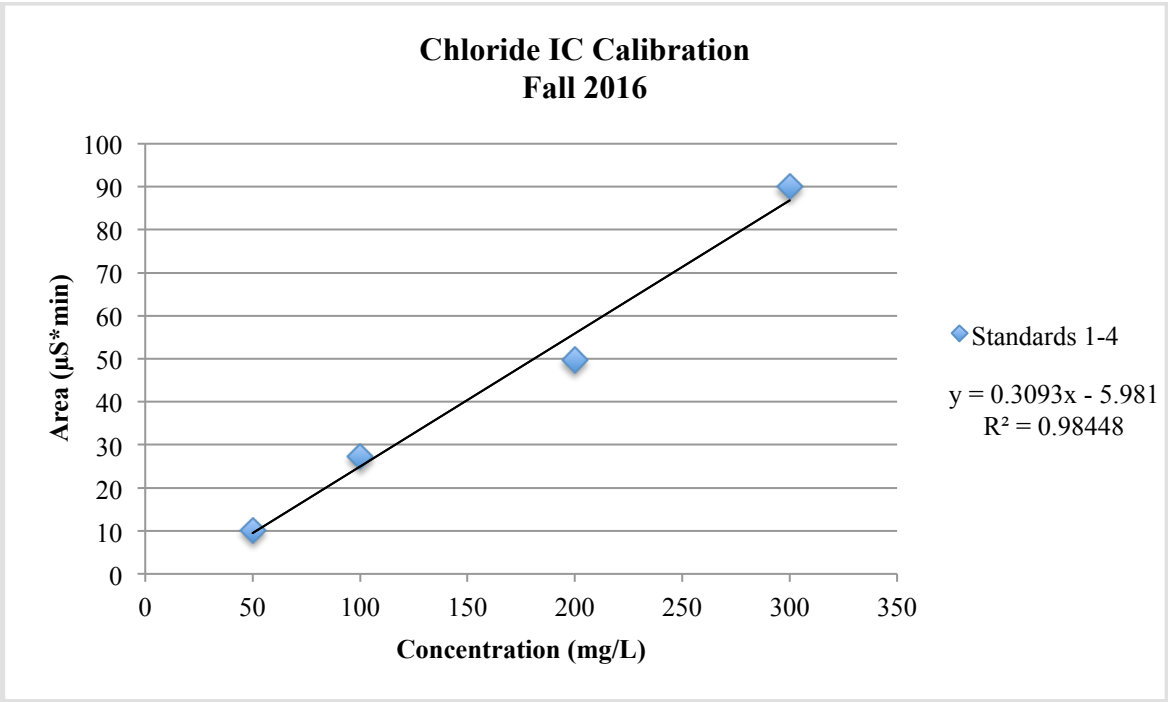

Chloride IC Results Fall 2016

| Sample ID | Sample Date | Area (µS*min) | Dilution | Corrected Concentration (mg/L) |
|------------------|--------------------|----------------------|-----------------|---------------------------------------|
| EM275 | 11/2/16 | 4.0022 | 1 | 32.27 |
| IZ385 | 11/2/16 | 58.5499 | 1 | 208.63 |
| IZ386 | 11/2/16 | 48.1804 | 1 | 175.10 |
| SV631 | 11/7/16 | 11.5855 | 1 | 56.79 |
| Well 11 | 11/3/16 | 46.2608 | 1 | 168.90 |
| Well 11 | 2/28/17 | 52.0216 | 1 | 175.28 |
| Well 12 | 11/3/16 | 39.231 | 1 | 146.17 |
| Well 12 | 2/28/17 | 42.764 | 1 | 144.66 |
| Well 13 | 11/3/16 | 18.3607 | 1 | 78.69 |
| Well 13 | 2/28/17 | 20.8693 | 1 | 72.26 |
| Hygeia Spring | 11/7/16 | 24.9133 | 1 | 99.88 |
| Fox 0 | 11/7/16 | 22.453 | 1 | 91.93 |
| Fox 1 | 11/7/16 | 43.5043 | 1 | 159.99 |
| Fox 2 | 11/7/16 | 49.2394 | 1 | 178.53 |
| Fox 3 | 11/7/16 | 29.6878 | 1 | 115.32 |
| Root River | 11/7/16 | 36.9636 | 1 | 138.84 |
| Sussex Creek | 11/7/16 | 58.7363 | 1 | 209.24 |
| Underwood Creek | 11/7/16 | 74.157 | 1 | 259.09 |
| Brookfield WWTP | 11/2/16 | 107.0934 | 1 | 365.58 |
| Sussex WWTP | 11/3/16 | 92.2269 | 1 | 317.52 |
| Waukesha WWTP | 11/3/16 | 122.1651 | 1 | 414.31 |

| Nitrate Standards IC Fall 2016 | | |
|--------------------------------|----------------------|---------------------------------------|
| Standard | Concentration (mg/L) | Area ($\mu\text{S}\cdot\text{min}$) |
| 1 | 1 | 0.0638 |
| 2 | 5 | 0.3862 |
| 3 | 10 | 0.9519 |
| 4 | 50 | 4.1398 |
| 5 | 100 | 10.5294 |

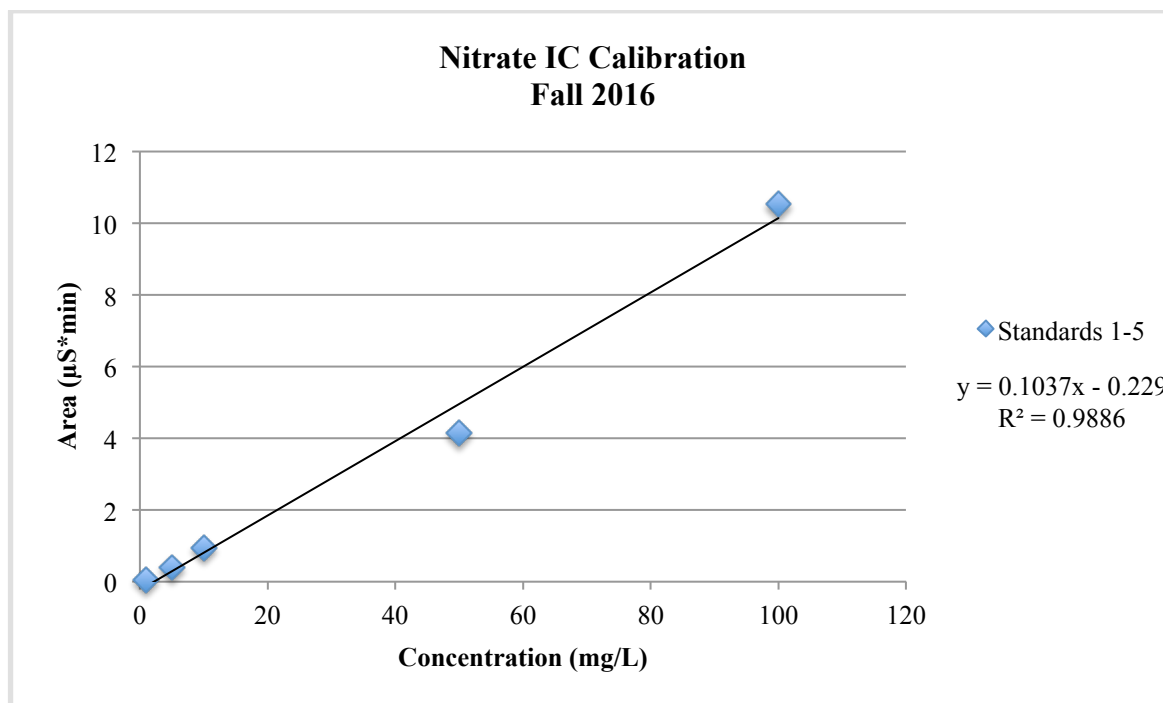

Nitrate IC Results Fall 2016

| Sample ID | Sample Date | Area (µS*min) | Dilution | Corrected Concentration (mg/L) |
|------------------|--------------------|----------------------|-----------------|---------------------------------------|
| EM275 | 11/2/16 | ND | 1 | ND |
| IZ385 | 11/2/16 | 0.3585 | 1 | 5.66 |
| IZ386 | 11/2/16 | 0.1118 | 1 | 3.28 |
| SV631 | 11/7/16 | 0.1032 | 1 | 3.20 |
| Well 11 | 11/3/16 | 4.1247 | 1 | 41.98 |
| Well 11 | 2/28/17 | ND | 1 | ND |
| Well 12 | 11/3/16 | 0.1074 | 1 | 3.25 |
| Well 12 | 2/28/17 | ND | 1 | ND |
| Well 13 | 11/3/16 | 0.0924 | 1 | 3.09 |
| Well 13 | 2/28/17 | 0.0524 | 1 | 2.99 |
| Hygeia Spring | 11/7/16 | 0.6899 | 1 | 8.86 |
| Fox 0 | 11/7/16 | 0.1636 | 1 | 3.79 |
| Fox 1 | 11/7/16 | 0.416 | 1 | 6.22 |
| Fox 2 | 11/7/16 | 0.8414 | 1 | 10.32 |
| Fox 3 | 11/7/16 | 0.3763 | 1 | 5.84 |
| Root River | 11/7/16 | 0.1837 | 1 | 3.98 |
| Sussex Creek | 11/7/16 | 0.772 | 1 | 9.65 |
| Underwood Creek | 11/7/16 | 0.1287 | 1 | 3.45 |
| Brookfield WWTP | 11/2/16 | 3.5628 | 1 | 36.57 |
| Sussex WWTP | 11/3/16 | 1.1434 | 1 | 13.23 |
| Waukesha WWTP | 11/3/16 | 8.7041 | 1 | 86.14 |

Phosphate Standards IC Fall 2016

| Standard | Concentration (mg/L) | Area ($\mu\text{S}\cdot\text{min}$) |
|----------|----------------------|---------------------------------------|
| 1 | 1 | 0.1092 |
| 2 | 5 | 0.3054 |
| 3 | 10 | 0.5971 |

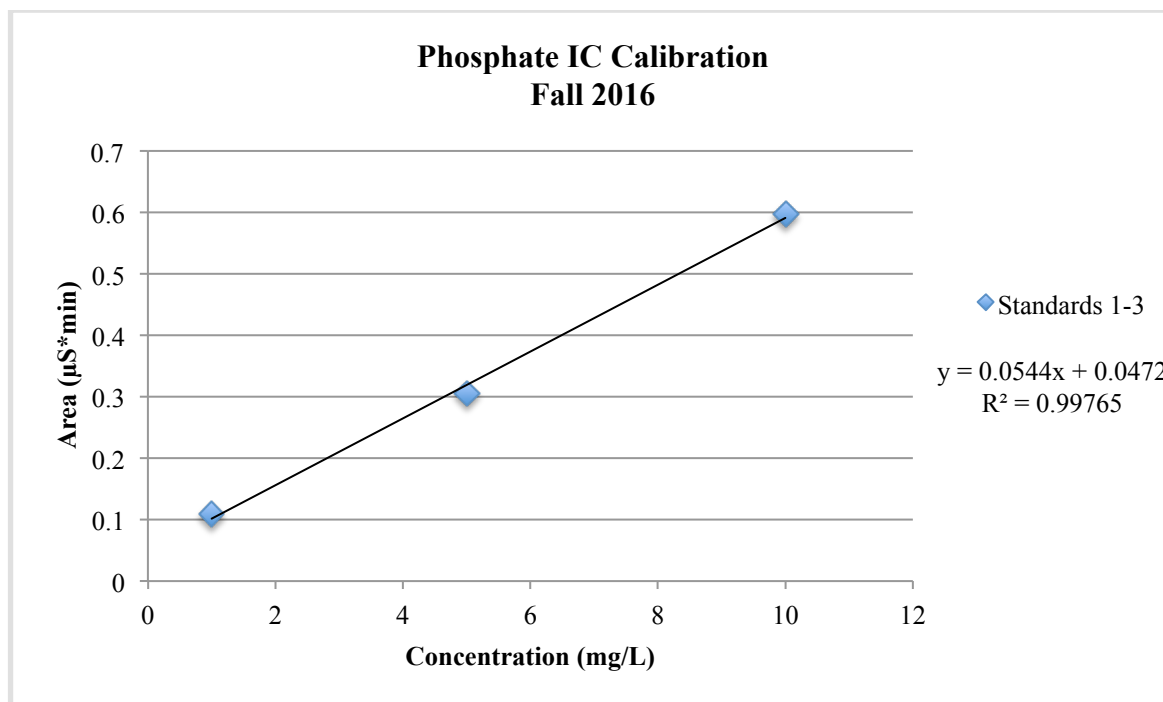

Phosphate IC Results Fall 2016

| Sample ID | Sample Date | Area (µS*min) | Dilution | Corrected Concentration (mg/L) |
|------------------|--------------------|----------------------|-----------------|---------------------------------------|
| EM275 | 11/2/16 | ND | 1 | ND |
| IZ385 | 11/2/16 | ND | 1 | ND |
| IZ386 | 11/2/16 | ND | 1 | ND |
| SV631 | 11/7/16 | ND | 1 | ND |
| Well 11 | 11/3/16 | ND | 1 | ND |
| Well 11 | 2/28/17 | ND | 1 | ND |
| Well 12 | 11/3/16 | ND | 1 | ND |
| Well 12 | 2/28/17 | ND | 1 | ND |
| Well 13 | 11/3/16 | ND | 1 | ND |
| Well 13 | 2/28/17 | ND | 1 | ND |
| Hygeia Spring | 11/7/16 | ND | 1 | ND |
| Fox 0 | 11/7/16 | ND | 1 | ND |
| Fox 1 | 11/7/16 | ND | 1 | ND |
| Fox 2 | 11/7/16 | ND | 1 | ND |
| Fox 3 | 11/7/16 | ND | 1 | ND |
| Root River | 11/7/16 | ND | 1 | ND |
| Sussex Creek | 11/7/16 | 0.0178 | 1 | 0.0019 |
| Underwood Creek | 11/7/16 | ND | 1 | ND |
| Brookfield WWTP | 11/2/16 | 0.111 | 1 | 0.06 |
| Sussex WWTP | 11/3/16 | 0.0237 | 1 | 0.0027 |
| Waukesha WWTP | 11/3/16 | ND | 1 | ND |

Sulfate Standards IC Fall 2016

| Standard | Concentration (mg/L) | Area ($\mu\text{S} \cdot \text{min}$) |
|----------|----------------------|---|
| 1 | 50 | 4.6667 |
| 2 | 100 | 12.3116 |
| 3 | 200 | 29.0221 |

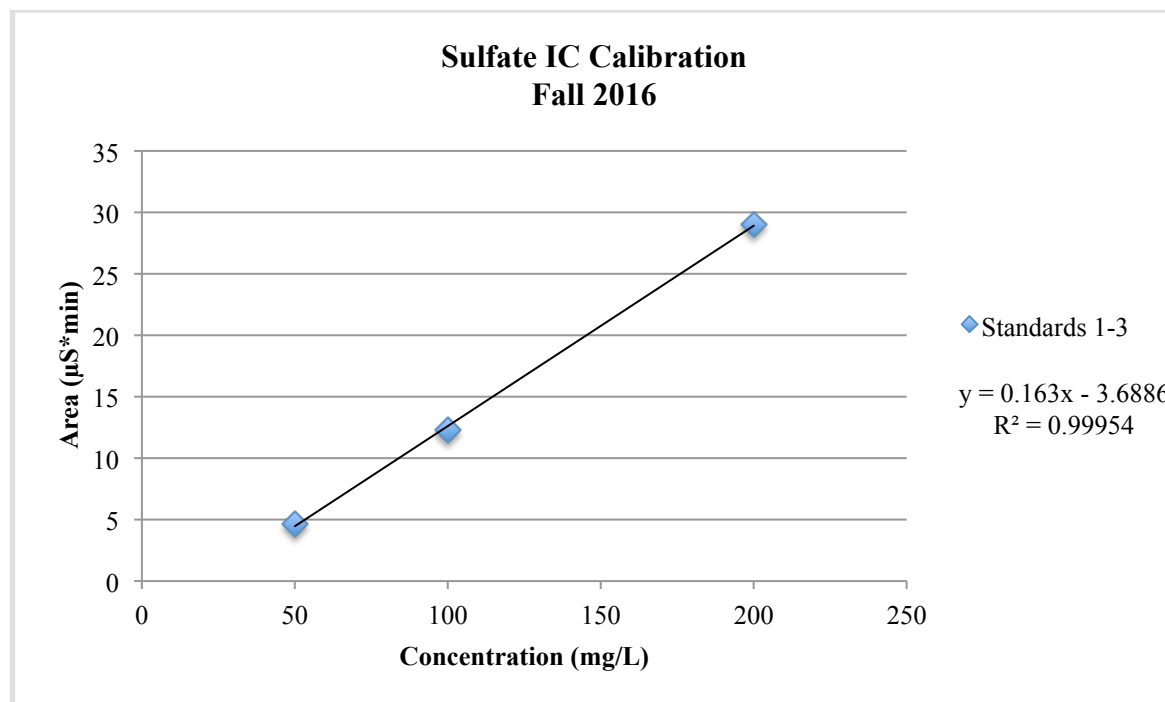

Sulfate IC Results Fall 2016

| Sample ID | Sample Date | Area (µS*min) | Dilution | Corrected Concentration (mg/L) |
|------------------|--------------------|----------------------|-----------------|---------------------------------------|
| EM275 | 11/2/16 | 22.4255 | 1 | 160.20 |
| IZ385 | 11/2/16 | 8.4671 | 1 | 74.57 |
| IZ386 | 11/2/16 | 10.752 | 1 | 88.59 |
| SV631 | 11/7/16 | 8.2001 | 1 | 72.93 |
| Well 11 | 11/3/16 | 7.9747 | 1 | 71.55 |
| Well 11 | 2/28/17 | 9.7141 | 1 | 69.96 |
| Well 12 | 11/3/16 | 9.6638 | 1 | 81.91 |
| Well 12 | 2/28/17 | 11.0009 | 1 | 77.76 |
| Well 13 | 11/3/16 | 12.8349 | 1 | 101.37 |
| Well 13 | 2/28/17 | 15.9286 | 1 | 111.44 |
| Hygeia Spring | 11/7/16 | 3.6049 | 1 | 44.75 |
| Fox 0 | 11/7/16 | 4.3006 | 1 | 49.01 |
| Fox 1 | 11/7/16 | 4.4014 | 1 | 49.63 |
| Fox 2 | 11/7/16 | 4.9983 | 1 | 53.29 |
| Fox 3 | 11/7/16 | 3.8671 | 1 | 46.35 |
| Root River | 11/7/16 | 8.1171 | 1 | 72.43 |
| Sussex Creek | 11/7/16 | 6.1127 | 1 | 60.13 |
| Underwood Creek | 11/7/16 | 16.9717 | 1 | 126.75 |
| Brookfield WWTP | 11/2/16 | 12.0731 | 1 | 96.70 |
| Sussex WWTP | 11/3/16 | 7.9351 | 1 | 71.31 |
| Waukesha WWTP | 11/3/16 | 9.4018 | 1 | 80.31 |

Chloride Standards IC Fall 2017

| Standard | Concentration (mg/L) | Area ($\mu\text{S} \cdot \text{min}$) |
|----------|----------------------|---|
| 1 | 1 | 0.1588 |
| 2 | 5 | 0.8667 |
| 3 | 10 | 1.8691 |
| 4 | 25 | 5.5210 |
| 5 | 50 | 13.0045 |
| 6 | 100 | 35.5377 |
| 7 | 200 | 76.4078 |

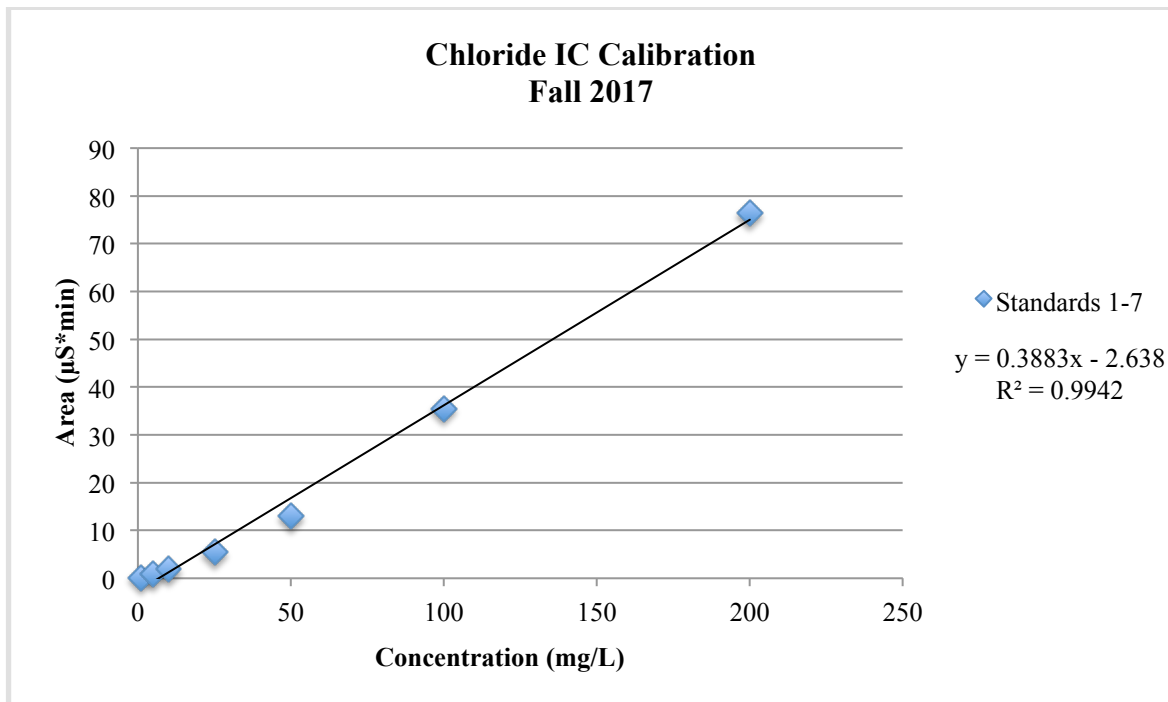

Chloride IC Results Fall 2017

| Sample ID | Sample Date | Area (µS*min) | Dilution | Corrected Concentration (mg/L) |
|------------------|--------------------|----------------------|-----------------|---------------------------------------|
| EM275 | 8/25/17 | 4.1439 | 1 | 17.47 |
| IZ385 | 8/25/17 | 53.0246 | 1 | 143.35 |
| SV631 | 9/15/17 | 12.2988 | 1 | 38.47 |
| Well 11 | 6/29/17 | 54.3669 | 1 | 146.81 |
| Well 11 | 7/27/17 | 85.5905 | 1 | 227.22 |
| Well 12 | 6/29/17 | 45.8174 | 1 | 124.79 |
| Well 12 | 7/27/17 | 54.7766 | 1 | 147.86 |
| Well 13 | 6/29/17 | 21.2926 | 1 | 61.63 |
| Well 13 | 7/27/17 | 17.9344 | 1 | 52.98 |
| Hygeia Spring | 8/20/17 | 25.0345 | 1 | 71.27 |
| Fox 0 | 8/5/17 | 18.8974 | 1 | 55.46 |
| Fox 1 | 8/19/17 | 61.3881 | 1 | 164.89 |
| Fox 2 | 8/20/17 | 62.0397 | 1 | 166.57 |
| Fox 3 | 8/20/17 | 33.7927 | 1 | 93.82 |
| Root River | 8/31/17 | 54.9556 | 1 | 148.32 |
| Sussex Creek | 8/5/17 | 42.0709 | 1 | 115.14 |
| Underwood Creek | 8/20/17 | 80.8923 | 1 | 215.12 |
| Brookfield WWTP | 8/24/17 | 135.9637 | 1 | 356.94 |
| Sussex WWTP | 8/31/17 | 111.7741 | 1 | 294.65 |
| Waukesha WWTP | 8/31/17 | 122.4699 | 1 | 322.19 |

| Nitrate Standards IC Fall 2017 | | |
|--------------------------------|----------------------|---|
| Standard | Concentration (mg/L) | Area ($\mu\text{S} \cdot \text{min}$) |
| 1 | 1 | 0.0571 |
| 2 | 5 | 0.3901 |
| 3 | 10 | 0.8197 |
| 4 | 25 | 2.2688 |
| 5 | 50 | 5.1365 |

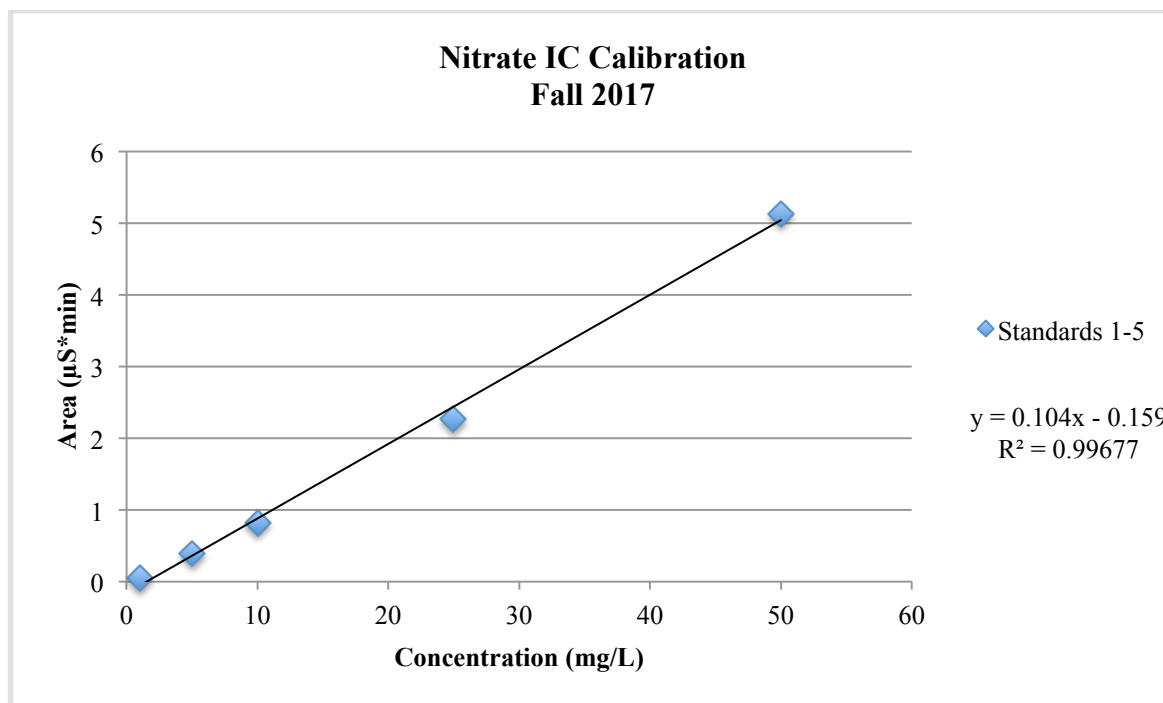

Nitrate IC Results Fall 2017

| Sample ID | Sample Date | Area (µS*min) | Dilution | Corrected Concentration (mg/L) |
|------------------|--------------------|----------------------|-----------------|---------------------------------------|
| EM275 | 8/25/17 | 0.0165 | 1 | 1.69 |
| IZ385 | 8/25/17 | 0.2304 | 1 | 3.74 |
| SV631 | 9/15/17 | ND | 1 | ND |
| Well 11 | 6/29/17 | 0.0232 | 1 | 1.75 |
| Well 11 | 7/27/17 | 0.1411 | 1 | 2.89 |
| Well 12 | 6/29/17 | ND | 1 | ND |
| Well 12 | 7/27/17 | ND | 1 | ND |
| Well 13 | 6/29/17 | 0.0702 | 1 | 2.20 |
| Well 13 | 7/27/17 | 0.0807 | 1 | 2.30 |
| Hygeia Spring | 8/20/17 | 0.8932 | 1 | 10.12 |
| Fox 0 | 8/5/17 | 0.1353 | 1 | 2.83 |
| Fox 1 | 8/19/17 | 0.5033 | 1 | 6.37 |
| Fox 2 | 8/20/17 | 1.0025 | 1 | 11.17 |
| Fox 3 | 8/20/17 | 0.2064 | 1 | 3.51 |
| Root River | 8/31/17 | 0.0481 | 1 | 1.99 |
| Sussex Creek | 8/5/17 | 0.6957 | 1 | 8.22 |
| Underwood Creek | 8/20/17 | ND | 1 | ND |
| Brookfield WWTP | 8/24/17 | 3.7249 | 1 | 37.35 |
| Sussex WWTP | 8/31/17 | 2.152 | 1 | 22.22 |
| Waukesha WWTP | 8/31/17 | 6.7554 | 1 | 64.80 |

Phosphate Standards IC Fall 2017

| Standard | Concentration (mg/L) | Area ($\mu\text{S}\cdot\text{min}$) |
|----------|----------------------|---------------------------------------|
| 1 | 1 | 0.0767 |
| 2 | 5 | 0.2476 |
| 3 | 10 | 0.4581 |

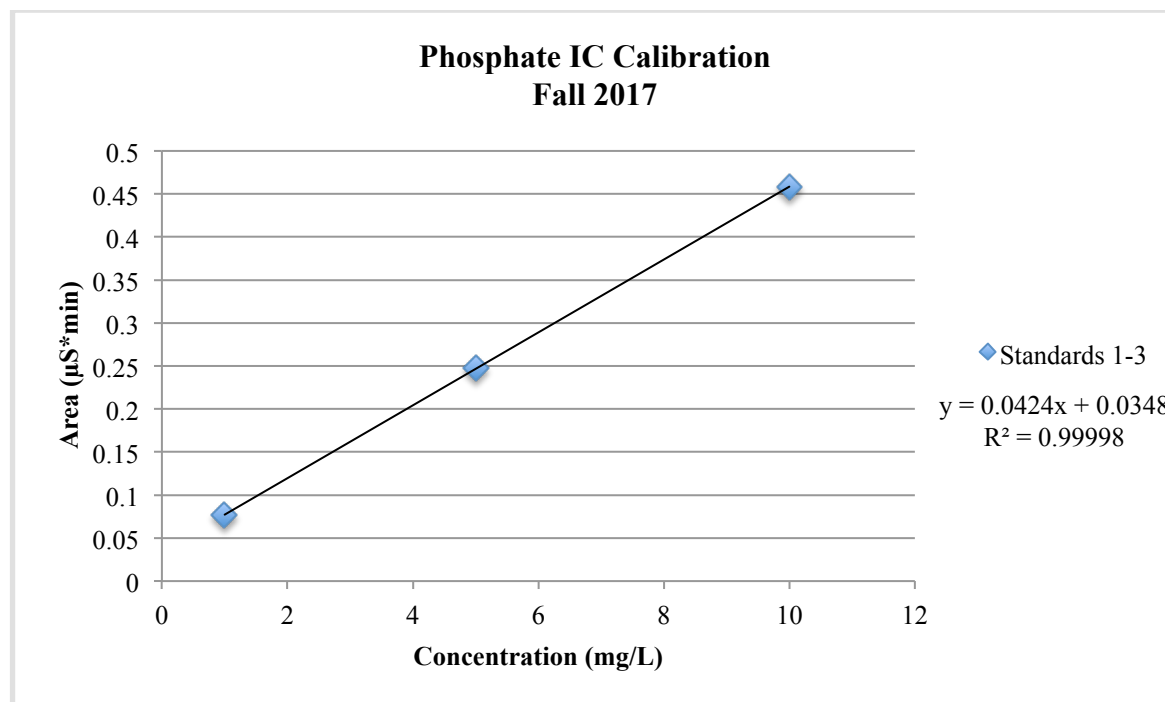

Phosphate IC Results Fall 2017

| Sample ID | Sample Date | Area (µS*min) | Dilution | Corrected Concentration (mg/L) |
|------------------|--------------------|----------------------|-----------------|---------------------------------------|
| EM275 | 8/25/17 | ND | 1 | ND |
| IZ385 | 8/25/17 | ND | 1 | ND |
| SV631 | 9/15/17 | ND | 1 | ND |
| Well 11 | 6/29/17 | ND | 1 | ND |
| Well 11 | 7/27/17 | ND | 1 | ND |
| Well 12 | 6/29/17 | ND | 1 | ND |
| Well 12 | 7/27/17 | ND | 1 | ND |
| Well 13 | 6/29/17 | ND | 1 | ND |
| Well 13 | 7/27/17 | ND | 1 | ND |
| Hygeia Spring | 8/20/17 | ND | 1 | ND |
| Fox 0 | 8/5/17 | ND | 1 | ND |
| Fox 1 | 8/19/17 | 0.0236 | 1 | 0.0018 |
| Fox 2 | 8/20/17 | 0.0202 | 1 | 0.0015 |
| Fox 3 | 8/20/17 | ND | 1 | ND |
| Root River | 8/31/17 | 0.0218 | 1 | 0.0016 |
| Sussex Creek | 8/5/17 | 0.0264 | 1 | 0.0020 |
| Underwood Creek | 8/20/17 | ND | 1 | ND |
| Brookfield WWTP | 8/24/17 | 0.0373 | 1 | 0.0028 |
| Sussex WWTP | 8/31/17 | 0.0856 | 1 | 0.0065 |
| Waukesha WWTP | 8/31/17 | 0.0257 | 1 | 0.0019 |

| Sulfate Standards IC Fall 2017 | | |
|--------------------------------|----------------------|------------------------------------|
| Standard | Concentration (mg/L) | Area ($\mu\text{S}^*\text{min}$) |
| 1 | 1 | 0.1056 |
| 2 | 5 | 0.4478 |
| 3 | 10 | 0.8955 |
| 4 | 25 | 2.4633 |
| 5 | 50 | 5.8342 |
| 6 | 100 | 12.5346 |
| 7 | 200 | 28.7261 |

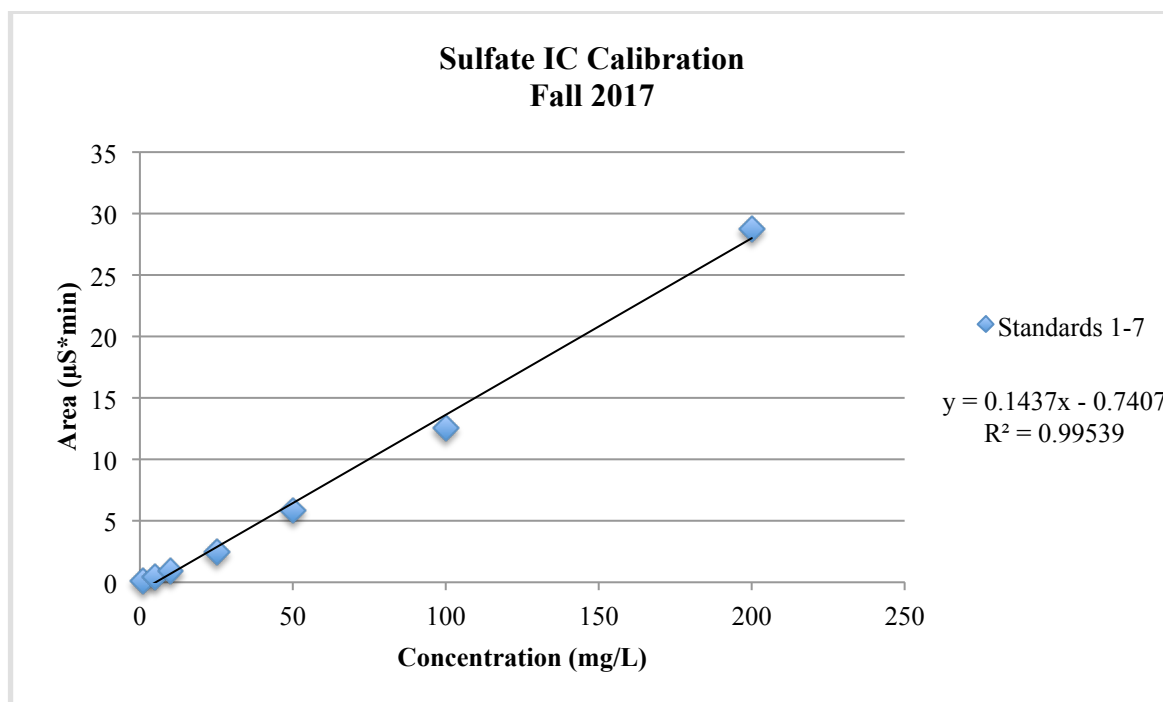

Sulfate IC Results Fall 2017

| Sample ID | Sample Date | Area (µS*min) | Dilution | Corrected Concentration (mg/L) |
|------------------|--------------------|----------------------|-----------------|---------------------------------------|
| EM275 | 8/25/17 | 20.3758 | 1 | 146.94 |
| IZ385 | 8/25/17 | 7.9666 | 1 | 60.59 |
| SV631 | 9/15/17 | 8.3029 | 1 | 62.93 |
| Well 11 | 6/29/17 | 9.0886 | 1 | 68.49 |
| Well 11 | 7/27/17 | 14.2338 | 1 | 104.20 |
| Well 12 | 6/29/17 | 10.6804 | 1 | 79.47 |
| Well 12 | 7/27/17 | 12.4047 | 1 | 91.47 |
| Well 13 | 6/29/17 | 15.2694 | 1 | 111.41 |
| Well 13 | 7/27/17 | 13.7305 | 1 | 100.70 |
| Hygeia Spring | 8/20/17 | 3.4659 | 1 | 29.27 |
| Fox 0 | 8/5/17 | 4.2497 | 1 | 34.73 |
| Fox 1 | 8/19/17 | 4.8882 | 1 | 39.17 |
| Fox 2 | 8/20/17 | 4.7785 | 1 | 38.41 |
| Fox 3 | 8/20/17 | 2.8173 | 1 | 24.76 |
| Root River | 8/31/17 | 8.3242 | 1 | 63.08 |
| Sussex Creek | 8/5/17 | 5.272 | 1 | 41.84 |
| Underwood Creek | 8/20/17 | 17.4386 | 1 | 126.51 |
| Brookfield WWTP | 8/24/17 | 10.5057 | 1 | 78.26 |
| Sussex WWTP | 8/31/17 | 9.0061 | 1 | 67.83 |
| Waukesha WWTP | 8/31/17 | 10.3772 | 1 | 77.37 |

Chloride Standards IC Winter 2017

| Standard | Concentration (mg/L) | Area ($\mu\text{S} \cdot \text{min}$) |
|----------|----------------------|---|
| 1 | 100 | 11.8654 |
| 2 | 200 | 29.3045 |
| 3 | 300 | 46.8190 |

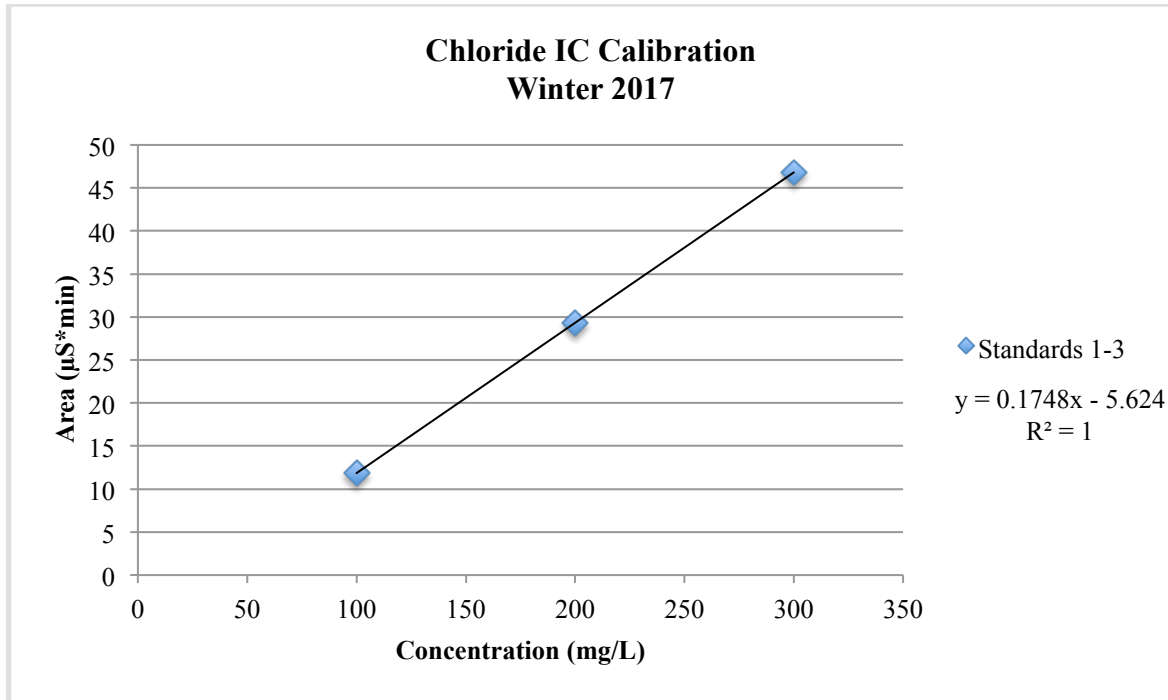

Chloride IC Results Winter 2017

| Sample ID | Sample Date | Area ($\mu\text{S} \cdot \text{min}$) | Dilution | Corrected Concentration (mg/L) |
|------------------|--------------------|---|-----------------|---------------------------------------|
| Well 11 | 11/8/17 | 46.4727 | 1 | 298.03 |
| Well 11 | 11/29/17 | 41.0466 | 1 | 266.99 |
| Well 11 | 12/1/17 | 38.1643 | 1 | 250.50 |
| Well 11 | 1/26/18 | 40.6966 | 1 | 264.99 |
| Well 12 | 11/8/17 | 39.9688 | 1 | 260.82 |
| Well 12 | 11/29/17 | 34.7154 | 1 | 230.77 |
| Well 12 | 12/1/17 | 37.0727 | 1 | 244.26 |
| Well 12 | 1/26/18 | 39.0832 | 1 | 255.76 |
| Well 13 | 11/8/17 | 15.435 | 1 | 120.47 |
| Well 13 | 11/29/17 | 17.0975 | 1 | 129.98 |
| Well 13 | 12/1/17 | 15.8553 | 1 | 122.87 |
| Well 13 | 1/26/18 | 15.441 | 1 | 120.50 |

| Nitrate Standards IC Winter 2017 | | |
|----------------------------------|----------------------|---|
| Standard | Concentration (mg/L) | Area ($\mu\text{S} \cdot \text{min}$) |
| 1 | 5 | 0.3530 |
| 2 | 10 | 0.8537 |
| 3 | 25 | 1.6857 |
| 4 | 50 | 3.9544 |
| 5 | 100 | 9.6821 |
| 6 | 200 | 21.1019 |
| 7 | 300 | 33.8444 |

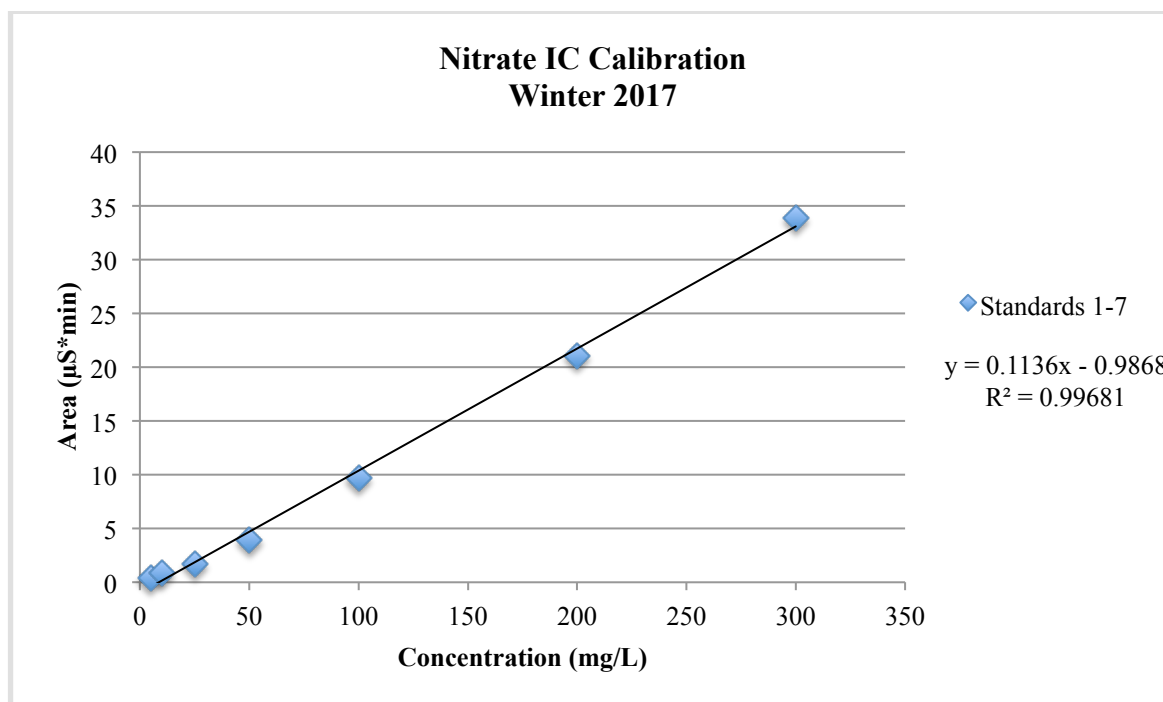

Nitrate IC Results Winter 2017

| Sample ID | Sample Date | Area (µS*min) | Dilution | Corrected Concentration (mg/L) |
|------------------|--------------------|----------------------|-----------------|---------------------------------------|
| Well 11 | 11/8/17 | 0.0523 | 1 | 0.0184 |
| Well 11 | 11/29/17 | 0.0502 | 1 | 0.4860 |
| Well 11 | 12/1/17 | 0.0521 | 1 | 0.0027 |
| Well 11 | 1/26/18 | 0.0417 | 1 | 0.0020 |
| Well 12 | 11/8/17 | ND | 1 | ND |
| Well 12 | 11/29/17 | ND | 1 | ND |
| Well 12 | 12/1/17 | ND | 1 | ND |
| Well 12 | 1/26/18 | ND | 1 | ND |
| Well 13 | 11/8/17 | 0.0415 | 1 | 0.0699 |
| Well 13 | 11/29/17 | 0.0421 | 1 | 1.42 |
| Well 13 | 12/1/17 | 0.0398 | 1 | 0.0016 |
| Well 13 | 1/26/18 | 0.0333 | 1 | 0.0014 |

| Phosphate Standards IC Winter 2017 | | |
|------------------------------------|----------------------|---|
| Standard | Concentration (mg/L) | Area ($\mu\text{S} \cdot \text{min}$) |
| 1 | 5 | 0.2203 |
| 2 | 10 | 0.4000 |
| 3 | 25 | 0.9369 |
| 4 | 50 | 1.8839 |
| 5 | 100 | 4.2517 |
| 6 | 200 | 10.0808 |
| 7 | 300 | 16.7702 |

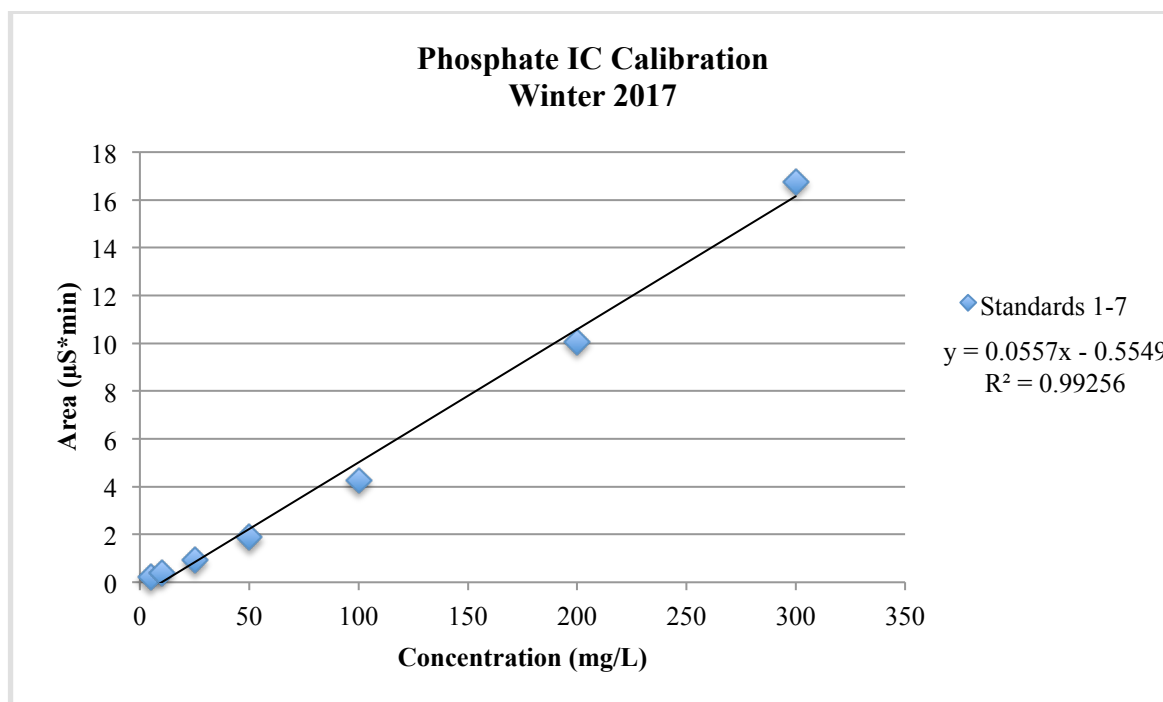

Phosphate IC Results Winter 2017

| Sample ID | Sample Date | Area ($\mu\text{S} \cdot \text{min}$) | Dilution | Corrected Concentration (mg/L) |
|------------------|--------------------|---|-----------------|---------------------------------------|
| Well 11 | 11/8/17 | ND | 1 | ND |
| Well 11 | 11/29/17 | ND | 1 | ND |
| Well 11 | 12/1/17 | ND | 1 | ND |
| Well 11 | 1/26/18 | ND | 1 | ND |
| Well 12 | 11/8/17 | ND | 1 | ND |
| Well 12 | 11/29/17 | ND | 1 | ND |
| Well 12 | 12/1/17 | ND | 1 | ND |
| Well 12 | 1/26/18 | ND | 1 | ND |
| Well 13 | 11/8/17 | ND | 1 | ND |
| Well 13 | 11/29/17 | ND | 1 | ND |
| Well 13 | 12/1/17 | ND | 1 | ND |
| Well 13 | 1/26/18 | ND | 1 | ND |

Sulfate Standards IC Winter 2017

| Standard | Concentration (mg/L) | Area ($\mu\text{S} \cdot \text{min}$) |
|----------|----------------------|---|
| 1 | 10 | 1.0738 |
| 2 | 25 | 2.7580 |
| 3 | 50 | 4.6449 |
| 4 | 100 | 12.3233 |
| 5 | 200 | 28.2426 |

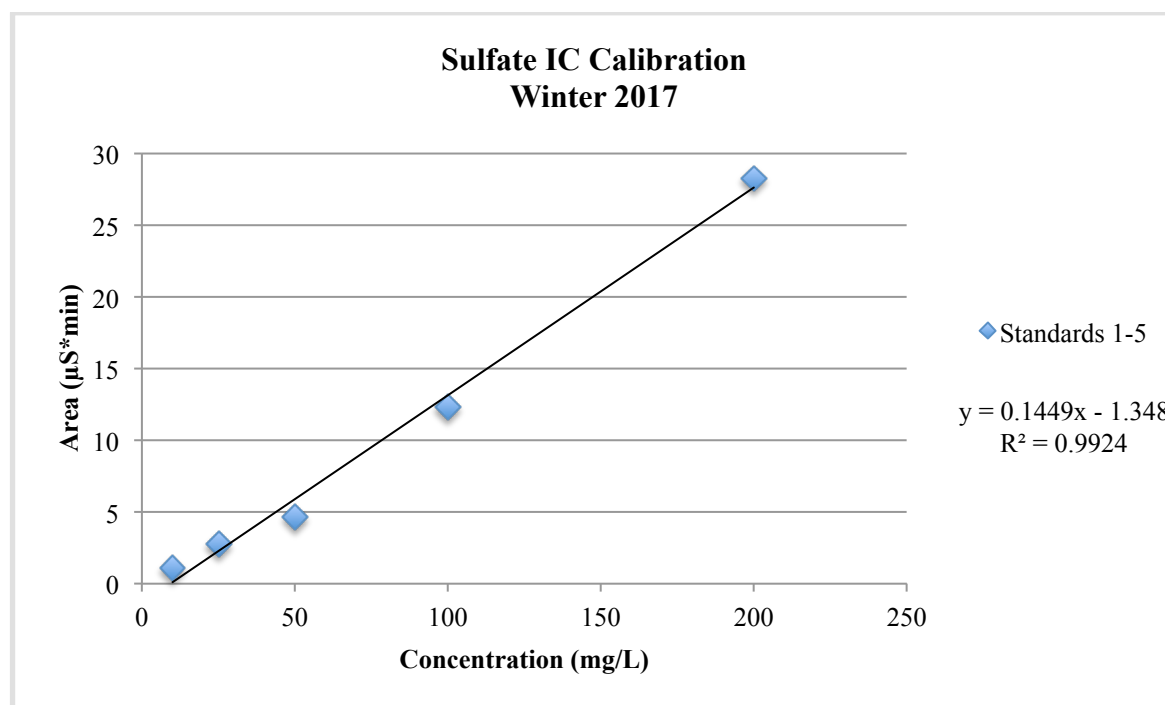

Phosphate IC Results Winter 2017

| Sample ID | Sample Date | Area (µS*min) | Dilution | Corrected Concentration (mg/L) |
|------------------|--------------------|----------------------|-----------------|---------------------------------------|
| Well 11 | 11/8/17 | 6.8345 | 1 | 56.46 |
| Well 11 | 11/29/17 | 6.2591 | 1 | 52.49 |
| Well 11 | 12/1/17 | 5.683 | 1 | 48.52 |
| Well 11 | 1/26/18 | 5.8526 | 1 | 49.69 |
| Well 12 | 11/8/17 | 6.6284 | 1 | 55.04 |
| Well 12 | 11/29/17 | 6.7624 | 1 | 55.97 |
| Well 12 | 12/1/17 | 6.865 | 1 | 56.68 |
| Well 12 | 1/26/18 | 7.4614 | 1 | 60.79 |
| Well 13 | 11/8/17 | 11.4399 | 1 | 88.25 |
| Well 13 | 11/29/17 | 12.1385 | 1 | 93.07 |
| Well 13 | 12/1/17 | 11.2587 | 1 | 87.00 |
| Well 13 | 1/26/18 | 11.1772 | 1 | 86.44 |

Ion Chromatography with Calibration Curves for Nutrient Species

| Nitrate Standards IC Fall 2017 | | |
|--------------------------------|----------------------|---|
| Standard | Concentration (mg/L) | Area ($\mu\text{S} \cdot \text{min}$) |
| 1 | 1 | 0.0571 |
| 2 | 5 | 0.3901 |
| 3 | 10 | 0.8197 |
| 4 | 25 | 2.2688 |
| 5 | 50 | 5.1365 |

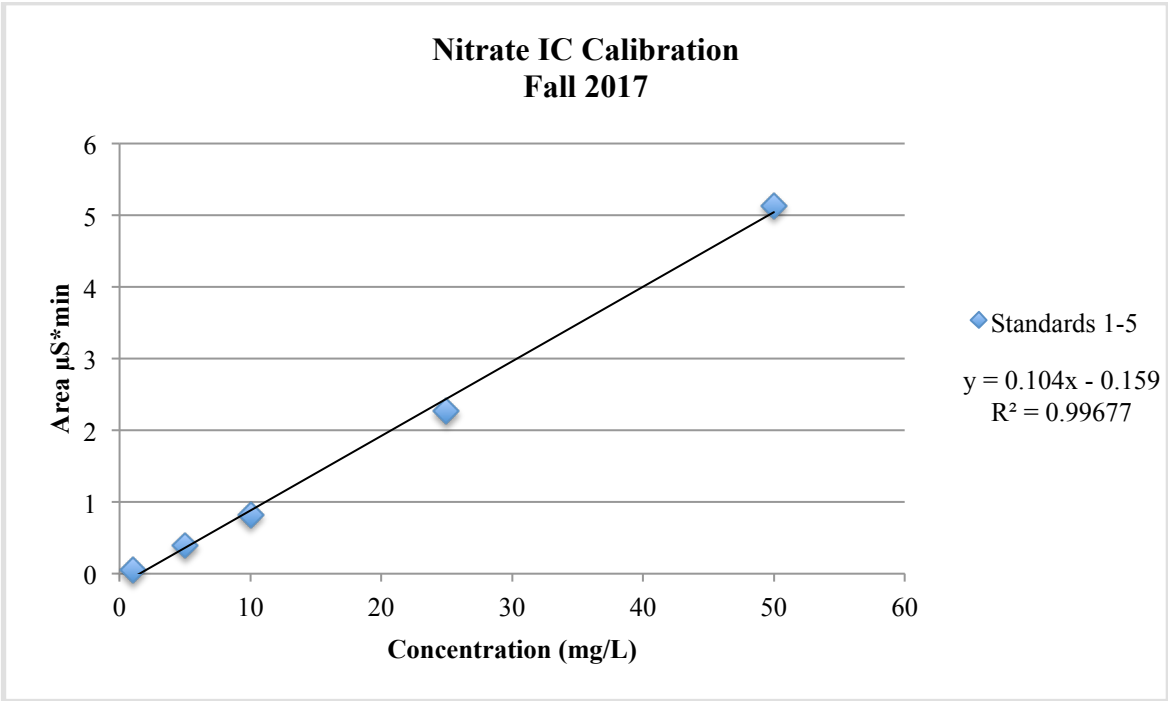

Nitrate IC Results Fall 2017

| Sample ID | Sample Date | Area ($\mu\text{S}\cdot\text{min}$) | Dilution | Corrected Concentration (mg/L) |
|------------------|--------------------|---|-----------------|---------------------------------------|
| Well 11 | 6/29/17 | 0.0232 | 1 | 1.75 |
| Well 11 | 7/13/17 | 0.0467 | 1 | 1.98 |
| Well 11 | 7/18/17 | 0.0283 | 1 | 1.80 |
| Well 11 | 7/20/17 | 0.0335 | 1 | 1.85 |
| Well 11 | 7/25/17 | 0.1115 | 1 | 2.60 |
| Well 11 | 7/27/17 | 0.1411 | 1 | 2.89 |
| Well 12 | 6/29/17 | ND | 1 | ND |
| Well 12 | 7/13/17 | ND | 1 | ND |
| Well 12 | 7/18/17 | ND | 1 | ND |
| Well 12 | 7/20/17 | ND | 1 | ND |
| Well 12 | 7/25/17 | ND | 1 | ND |
| Well 12 | 7/27/17 | ND | 1 | ND |
| Well 13 | 6/29/17 | 0.0702 | 1 | 2.20 |
| Well 13 | 7/13/17 | 0.1306 | 1 | 2.78 |
| Well 13 | 7/18/17 | 0.0730 | 1 | 2.23 |
| Well 13 | 7/20/17 | 0.0790 | 1 | 2.29 |
| Well 13 | 7/25/17 | 0.2075 | 1 | 3.52 |
| Well 13 | 7/27/17 | 0.0807 | 1 | 2.30 |
| Fox River | 7/25/17 | 0.4230 | 1 | 5.60 |

| Nitrate Standards IC Winter 2017 | | |
|----------------------------------|----------------------|------------------------------------|
| Standard | Concentration (mg/L) | Area ($\mu\text{S}^*\text{min}$) |
| 1 | 5 | 0.3530 |
| 2 | 10 | 0.8537 |
| 3 | 25 | 1.6857 |
| 4 | 50 | 3.9544 |
| 5 | 100 | 9.6821 |
| 6 | 200 | 21.1019 |
| 7 | 300 | 33.8444 |

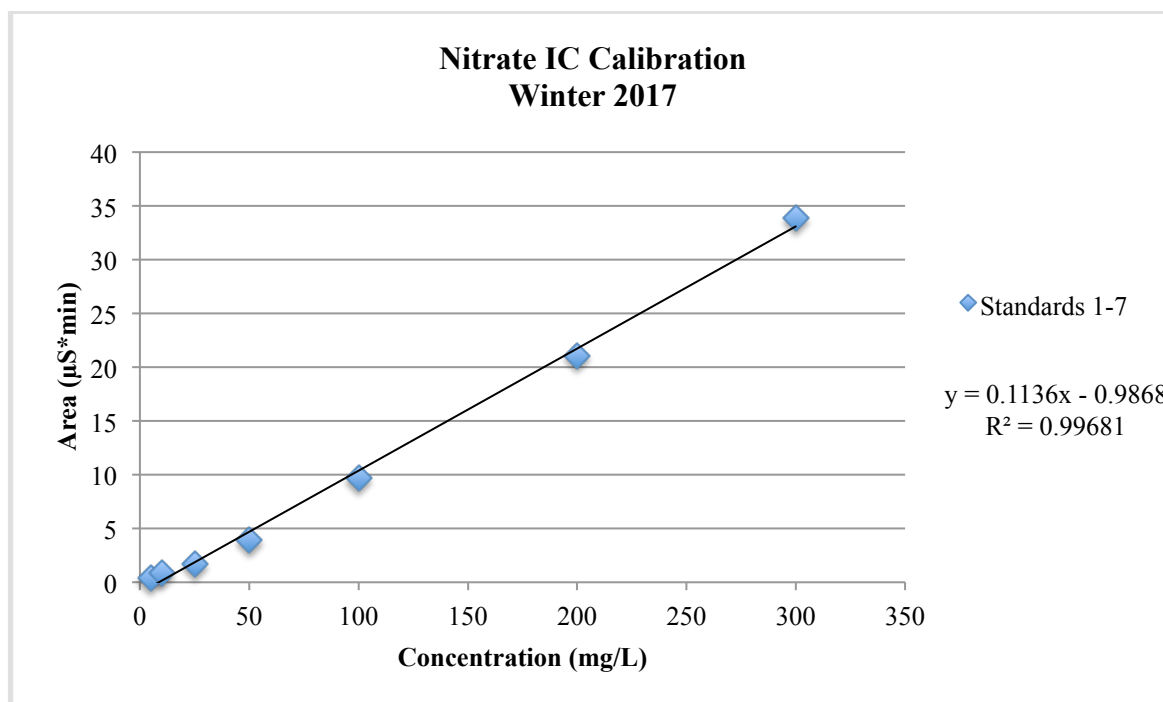

Nitrate IC Results Winter 2017

| Sample ID | Sample Date | Area ($\mu\text{S} \cdot \text{min}$) | Dilution | Corrected Concentration (mg/L) |
|------------------|--------------------|---|-----------------|---------------------------------------|
| Well 11 | 11/8/17 | 0.0523 | 1 | 0.0184 |
| Well 11 | 11/29/17 | 0.0502 | 1 | 0.4860 |
| Well 11 | 12/1/17 | 0.0521 | 1 | 0.0027 |
| Well 11 | 1/26/18 | 0.0417 | 1 | 0.0020 |
| Well 12 | 11/8/17 | ND | 1 | ND |
| Well 12 | 11/29/17 | ND | 1 | ND |
| Well 12 | 12/1/17 | ND | 1 | ND |
| Well 12 | 1/26/18 | ND | 1 | ND |
| Well 13 | 11/8/17 | 0.0415 | 1 | 0.0699 |
| Well 13 | 11/29/17 | 0.0421 | 1 | 1.42 |
| Well 13 | 12/1/17 | 0.0398 | 1 | 0.0016 |
| Well 13 | 1/26/18 | 0.0333 | 1 | 0.0014 |

Auto Analyzer with Calibration Curves for Nutrient Species

SEAL Analytical

Application Lab

Name of run :1704050.run
 Comment :Low Range NH3

Name of analysis :Nitrite-Ammonia.BSL
 Date of report :4/5/2017

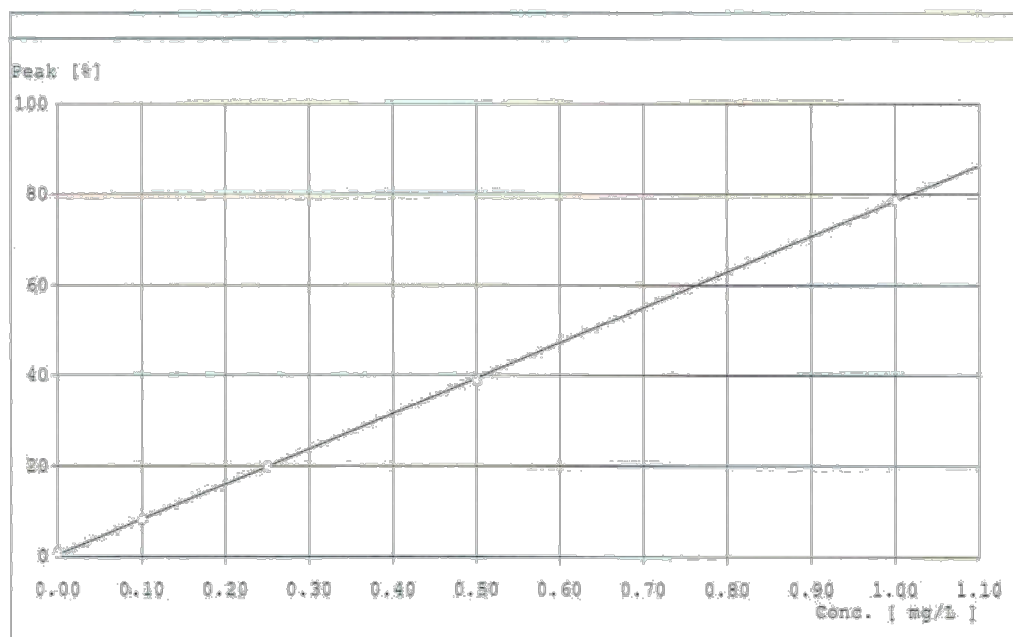

Channel :2
 Method :Ammonia
 Curve fit :linear
 Corr.coeff. (r) :0.9999

Date of Run :4/5/2017

Equation :y = bx + a

y = conc. in
 x = peak height in digital units
 a = -6.7540E-002
 b = 1.9845E-005

Corrections
 Baseline Corr. done
 Drift Correction no
 Carryover Corr. done 0.34 s

Calibrant Values

| Type | Calculated | Target | Diff. [mg/L] | Diff. (%) |
|------|------------|--------|--------------|-----------|
| 1C | 1.003 | 1.000 | 0.003 | 0.30 |
| 2C | 0.485 | 0.500 | -0.005 | -1.01 |
| 3C | 0.249 | 0.250 | -0.001 | -0.35 |
| 4C | 0.098 | 0.100 | -0.002 | -1.56 |
| 5C | 0.005 | 0.000 | 0.005 | --- |

SEAL Analytical

Application Lab

Name of run :170405A.run
 Comment :Low Range NH3

Name of analysis :Nitrite-Ammonia.ANL
 Date of report :4/5/2017

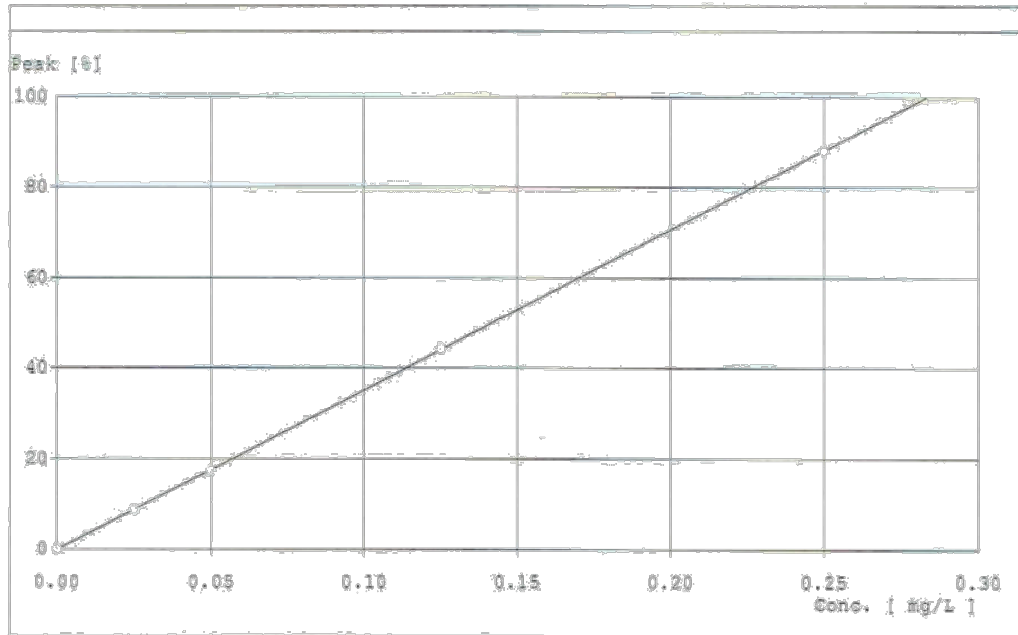

Channel :1
 Method :Nitrite
 Curve fit :Linear
 Corr.coeff. (r) :1.0000

Date of run :4/5/2017

Equation :y = bx + a

y = conc. in
 x = peak height in digital units
 a = -1.2068E-002
 b = 4.3166E-006

Corrections
 Baseline Corr. done
 Drift Correction no
 Carryover Corr. done 0.34 %

Calibrant Values

| Type | Calculated | Target | Diff. (mg/L) | Diff. (%) |
|------|------------|--------|--------------|-----------|
| 1c | 0.250 | 0.250 | 0.000 | -0.08 |
| 2c | 0.126 | 0.125 | 0.001 | 0.83 |
| 3c | 0.048 | 0.050 | -0.001 | -1.12 |
| 4c | 0.025 | 0.025 | 0.000 | -0.51 |
| 5c | 0.000 | 0.000 | 0.000 | --- |

SEAL Analytical

Application Lab

```

Name of Run       : 170405A
Date of Report    : 4/5/2017
Run Start         : 4/5/2017 4:09:51 PM
Operator          :
Comment           : Low Range NH3

Name of Analysis  : Nitrite-Ammonia.ANL
System            : 1 / AA3 HR
Run Stop          : 4:37:48 PM
  
```

```

Channel      :          1          2
Method       :          Nitrite   Ammonia
Unit         :          mg/L      mg/L
Calibr. Fit  :          Linear    Linear
Conn. Coeff.(r) :      1.0000    0.9999
Base        :      -9646         -4882
Gain        :          181         13
Sensitivity  :          0.0487    0.0034
Sample Limit 1 :
Sample Limit 2 :
  
```

| Pk | Cup | Sample ID | Value | Value |
|----|-----|-----------------------|--------|--------|
| 0 | 0 | B Baseline | 0.000 | -0.005 |
| 1 | 901 | P Primer | 0.250 | 0.999 |
| 2 | 901 | D Drift | 0.250 | 1.008 |
| 3 | 901 | C 1 ppm NH4 0.250NO2 | 0.250 | 1.003 |
| 4 | 902 | C 0.5ppm NH4 0.125NO2 | 0.126 | 0.495 |
| 5 | 903 | C 0.25ppm NH4 0.05NO2 | 0.049 | 0.249 |
| 6 | 904 | C 0.1ppm NH4 0.025NO2 | 0.025 | 0.098 |
| 7 | 905 | C Standard 0. ppb | 0.000 | 0.005 |
| 8 | 901 | H1 High | 0.250 | 0.996 |
| 9 | 904 | L1 Low | 0.025 | 0.098 |
| 10 | 904 | L1 Low | 0.025 | 0.098 |
| 11 | 1 | S Well 11 H | 0.088 | 0.007 |
| 12 | 2 | S Well 11 T | 0.086 | 0.001 |
| 13 | 3 | S Well 12 H | 0.004 | 0.068 |
| 14 | 4 | S Well 12 T | 0.004 | 0.072 |
| 15 | 5 | S Well 13 H | 0.043 | 0.029 |
| 16 | 7 | S Well 13 T | 4.214* | 1.232* |
| 17 | 901 | D Drift | 0.236 | 0.969 |
| 18 | 0 | B Final Base | 0.000 | -0.005 |

```

CORRECTIONS:
Channel      :          1          2
Baseline     :          Yes       Yes
Drift        :          No        No
Carryover    :          Yes       Yes
%:           :          0.3       0.3
  
```

```

* ... Sample offscale
+ ... Result higher than sample limit
- ... Result lower than sample limit
P ... Standard passed
F ... Standard failed
N ... Value not calculated or not used
R ... Resample after offscale
M ... Peak marker moved manually
D ... Diluted sample
H ... Dual calibration used
  
```

```
** <END OF REPORT> **
```

SEAL Analytical

Application Lab

Name of run : i71105.sus
 Comment : Low Range NH3

Name of analysis : Nitrate-Ammonia.ANL
 Date of report : 2/26/2018

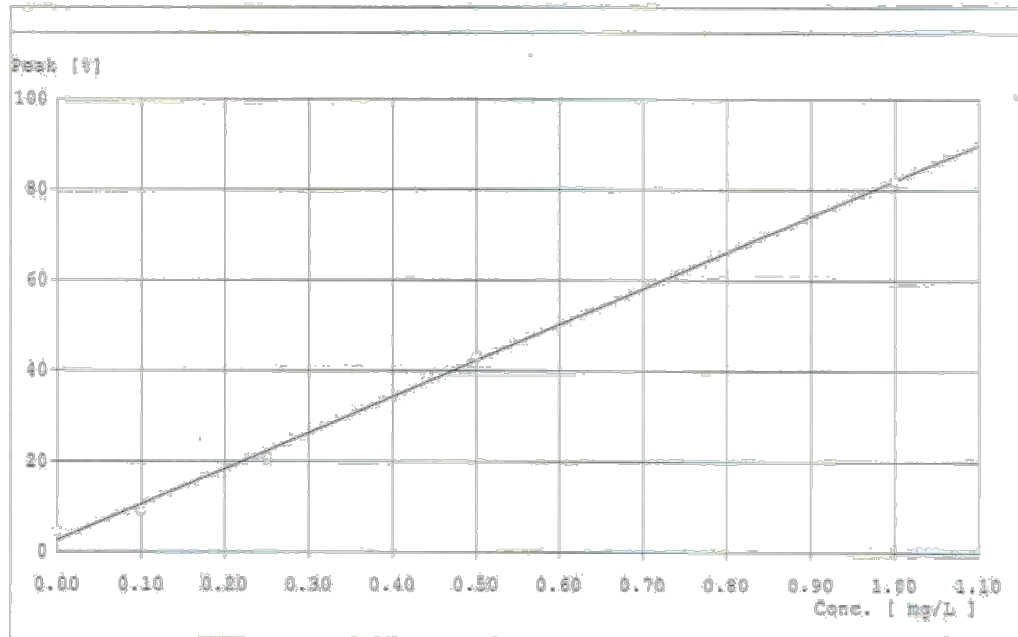

Channel : 2
 Method : ammonia
 Curve Fit : linear
 Corr. coeff. (r) : 0.9990

Date of run : 11/3/2017

Equation : $y = bx + a$

y = concn. in
 x = peak height in digital units
 $a = -9.4212E-002$
 $b = 1.9204E-005$

Corrections
 Baseline Corr. : done
 Drift Correction : done
 Carryover Corr. : done 0.43 %

Calibrant Values

| Type | Calculated | Target | Diff. [mg/L] | Diff. (%) |
|------|------------|--------|--------------|-----------|
| 1C | 0.999 | 1.000 | -0.001 | -0.12 |
| 2C | 0.512 | 0.500 | 0.012 | 2.43 |
| 3C | 0.232 | 0.250 | -0.018 | -7.28 |
| 4C | 0.084 | 0.100 | -0.016 | -16.18 |
| 5C | 0.023 | 0.000 | 0.023 | --- |

SEAL Analytical

Application Lab

Name of run :171103.run
 Comment :Low Range NH3

Name of analysis :Nitrite-Ammonia.NHL
 Date of report :2/3/2019

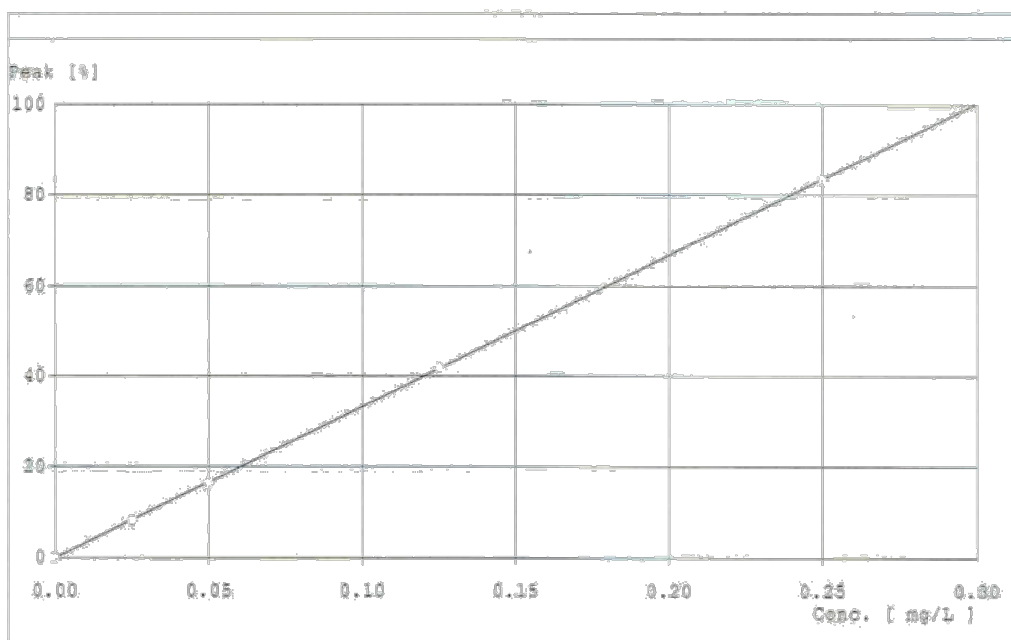

Channel :1
 Method :Nitrite
 Curve Fit :linear
 Corr. coeff. (r) :1.0000

Date of run :11/1/2017

Equation :y = bx + a

y = conc. in
 x = peak height in digital units
 a = -1.5367E-002
 b = 4.5028E-006

Corrections
 Baseline Corr. done
 Drift Correction done
 Carryover Corr. done 0.13 %

Calibrant Values

| Type | Calculated | Target | Diff. (mg/L) | Diff. (%) |
|------|------------|--------|--------------|-----------|
| 1C | 0.250 | 0.250 | 0.000 | -0.11 |
| 2C | 0.125 | 0.125 | 0.001 | 0.84 |
| 3C | 0.049 | 0.050 | -0.001 | -1.03 |
| 4C | 0.025 | 0.025 | 0.000 | -0.68 |
| 5C | 0.000 | 0.000 | 0.000 | --- |

SEAL Analytical

Application Lab

Name of Run : 171103
 Date of Report : 2/9/2018
 Run Start : 11/3/2017 2:20:34 PM
 Operator :
 Comment : Low Range NH3

Name of Analysis : Nitrite-Ammonia.ANL
 System : 1 / AAS HR
 Run Stop : 3:05:55 PM

| Channel | 1 | 2 |
|------------------|---------|---------|
| Method | Nitrite | Ammonia |
| Unit | mg/L | mg/L |
| Calibr. Fit | Linear | Linear |
| Corr. Coeff. (r) | 1.0000 | 0.9990 |
| Base | -9324 | -4883 |
| Gain | 81 | 19 |
| Sensitivity | 0.1028 | 0.4194 |
| Sample Limit 1 | | |
| Sample Limit 2 | | |

| Pk | Cup | Sample ID | Value | Value |
|----|-----|-----------------------|-------|--------|
| 0 | 0 | B Baseline | 0.000 | -0.032 |
| 1 | 901 | P Primer | 0.249 | 0.971 |
| 2 | 901 | D Drift | 0.249 | 0.977 |
| 3 | 901 | C 1 ppm NH4 0.250NO2 | 0.250 | 0.999 |
| 4 | 902 | C 0.5ppm NH4 0.125NO2 | 0.126 | 0.512 |
| 5 | 903 | C 0.25ppm NH4 0.05NO2 | 0.049 | 0.232 |
| 6 | 904 | C 0.10ppmNH4 0.025NO2 | 0.025 | 0.084 |
| 7 | 905 | C Standard 0 ppb | 0.000 | 0.023 |
| 8 | 901 | H1 High | 0.249 | 0.964 |
| 9 | 904 | L1 Low | 0.025 | 0.088 |
| 10 | 904 | L1 Low | 0.025 | 0.088 |
| 11 | 1 | S Well 11 6-29 | 0.036 | -0.010 |
| 12 | 2 | S 12 6-29 | 0.001 | 0.081 |
| 13 | 3 | S 13 6-29 | 0.043 | 0.025 |
| 14 | 4 | S 14 6-29 | 0.000 | -0.017 |
| 15 | 5 | S 11 7-13 | 0.031 | 0.002 |
| 16 | 6 | S 12 7-13 | 0.001 | 0.063 |
| 17 | 7 | S 13 7-13 | 0.048 | 0.040 |
| 18 | 8 | S 11 7-18 | 0.023 | -0.019 |
| 19 | 9 | S 12 7-18 | 0.001 | 0.059 |
| 20 | 10 | S 13 7-18 | 0.023 | 0.006 |
| 21 | 11 | S 14 7-18 | 0.000 | -0.025 |
| 22 | 12 | S 11 7-20 | 0.027 | -0.012 |
| 23 | 13 | S 12 7-20 | 0.001 | 0.083 |
| 24 | 14 | S 13 7-20 | 0.037 | 0.022 |
| 25 | 15 | S 14 7-20 | 0.000 | -0.025 |
| 26 | 16 | S 11 7-25 | 0.040 | -0.013 |
| 27 | 17 | S 12 7-25 | 0.001 | 0.057 |
| 28 | 18 | S 13 7-25 | 0.025 | 0.014 |
| 29 | 19 | S 14 7-25 | 0.000 | -0.012 |
| 30 | 20 | S riv 7-25 | 0.046 | 0.026 |
| 31 | 21 | S 11 7-27 | 0.024 | -0.023 |
| 32 | 22 | S 12 7-27 | 0.001 | 0.075 |
| 33 | 23 | S 13 7-27 | 0.036 | 0.023 |
| 34 | 24 | S 14 7-27 | 0.000 | -0.025 |
| 35 | 901 | D Drift | 0.249 | 0.977 |
| 36 | 0 | B Final Base | 0.000 | -0.032 |

| CORRECTIONS | 1 | 2 |
|-------------|-----|-----|
| Channel | | |
| Baseline | Yes | Yes |
| Drift | Yes | Yes |
| Carryover | Yes | Yes |

WT: 0.1 0.4

* ... Sample offscale
+ ... Result higher than sample limit
- ... Result lower than sample limit
P ... Standard passed
F ... Standard failed
N ... Value not calculated or not used
R ... Resample after offscale
M ... Peak marker moved manually
D ... Diluted sample
H ... Dual calibration used

** <END OF REPORT> **

SEAL Analytical

Application Lab

Name of run :190202A.run
 Comment :Low Range NHS

Name of analysis :Nitrite-Ammonia.ANL
 Date of report :2/26/2018

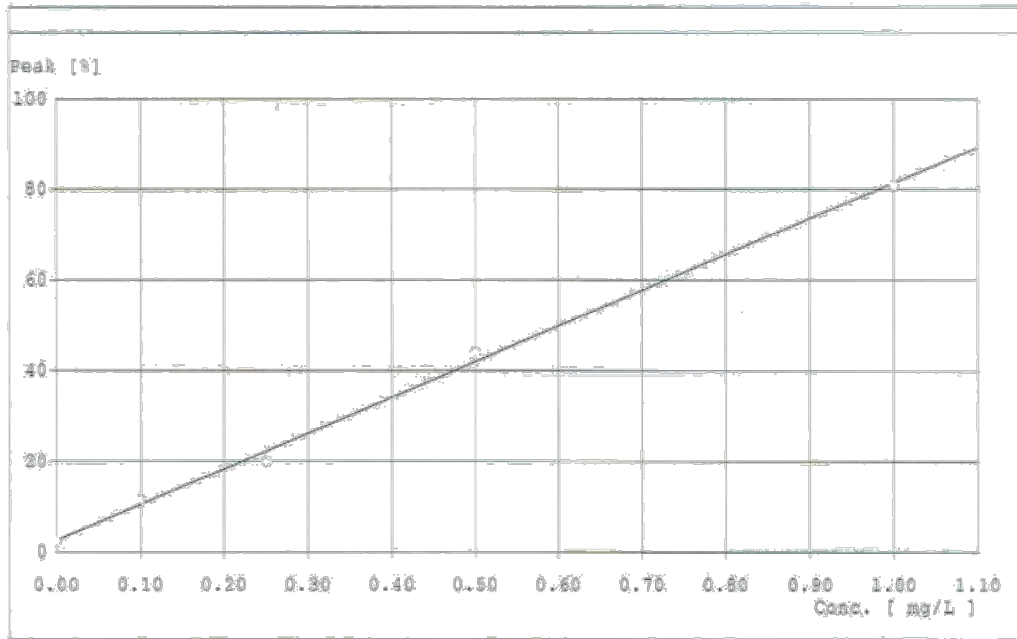

Channel :2
 Method :Ammonia
 Curve fit :Linear
 Corr. coeff. (r) :0.9986

Date of run :2/2/2018

Equation :y = bx + a
 y = conc. in
 x = peak height in digital units
 a = -9.58075-002
 b = 1.23482E-005

Corrections
 Baseline Corr. done
 Drift Correction done
 Carryover Corr. done 0.61 %

Calibrant Values

| Type | Calculated | Target | Diff. [mg/L] | Diff. (%) |
|------|------------|--------|--------------|-----------|
| 1C | 0.991 | 1.000 | -0.009 | -0.91 |
| 2C | 0.926 | 0.900 | 0.026 | 2.88 |
| 3C | 0.221 | 0.250 | -0.029 | -11.48 |
| 4C | 0.118 | 0.100 | 0.018 | 18.18 |
| 5C | -0.002 | 0.000 | -0.002 | -- |

SEAL Analytical

Application Lab

Name of run :180202A.run
 Comment :16w Range NR3

Name of analysis :Nitrite-Ammonia.AMI
 Date of report :2/9/2018

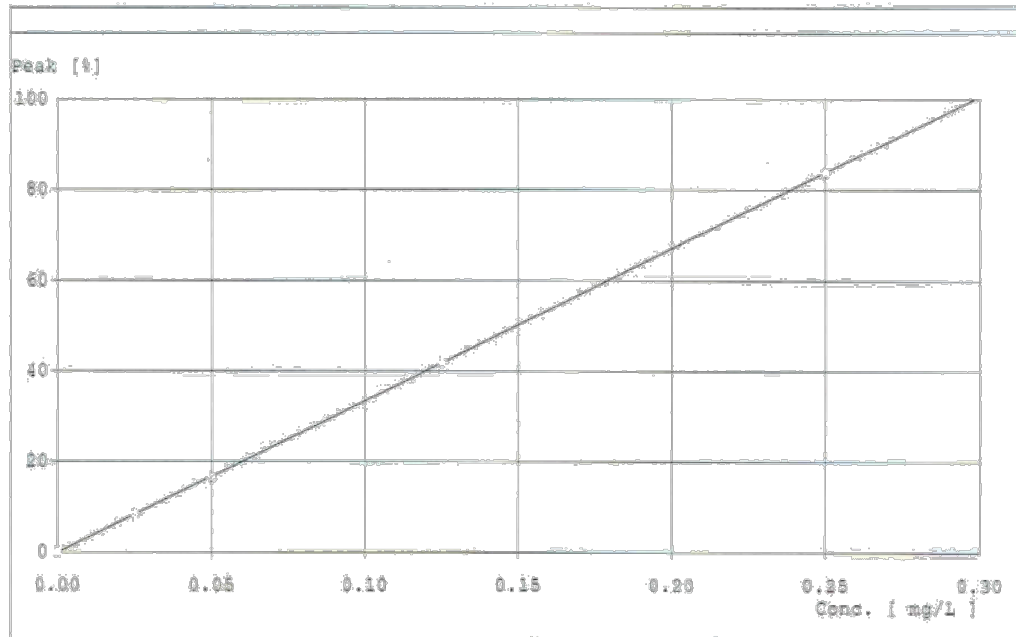

Channel :1
 Method :Nitrite
 Curve fit :linear
 Comp. coeff. (r) :1.0000

Date of run :2/2/2018

Equation :y = bx + a

y = conc. in
 x = peak height in digital units
 a = -1.4817E-002
 b = 4.5436E-008

Corrections
 Baseline Corr. done
 Drift Correction. done
 Carryover Corr. done 0.23 %

Calibrant Values:

| Type | Calculated | Target | Diff. (mg/L) | Diff. (%) |
|------|------------|--------|--------------|-----------|
| 1C | 0.250 | 0.250 | 0.000 | -0.05 |
| 2C | 0.125 | 0.125 | 0.000 | 0.36 |
| 3C | 0.050 | 0.050 | 0.000 | -0.88 |
| 4C | 0.025 | 0.025 | 0.000 | -0.72 |
| 5C | 0.000 | 0.000 | 0.000 | --- |

SEAL Analytical

Application Lab.

```

Name of Run      : 180202A
Date of Report  : 2/9/2018
Run Start       : 2/2/2018 2:42:26 PM
Operator        : Maddy
Comment         : Low Range NH3
                  Wells

Name of Analysis : Nitrite-Ammonia.ANL
System          : 1 / AA3 HR
Run Stop        : 3:19:58 PM
    
```

```

Channel      : 1      2
Method       : Nitrite Ammonia
Unit         : mg/L   mg/L
Calibr. Fit  : Linear Linear
Corr. Coeff.(r) : 1.0000 0.9986
Base        : -9393  -4727
Gain        : 71     17
Sensitivity  : 0.1178 0.4728
Sample Limit 1 :
Sample Limit 2 :
    
```

| Pk | Cup | Sample ID | Value | Value |
|----|-----|-----------------------|-------|--------|
| 0 | 0 | B Baseline | 0.000 | -0.033 |
| 1 | 901 | P Primer | 0.249 | 0.987 |
| 2 | 901 | D Drift | 0.249 | 0.983 |
| 3 | 901 | C 1 ppm NH4 0.25NO2 | 0.250 | 0.991 |
| 4 | 902 | C 0.5ppm NH4 0.125NO2 | 0.125 | 0.526 |
| 5 | 903 | C 0.25ppm NH4 0.05NO2 | 0.050 | 0.221 |
| 6 | 904 | C 0.10ppmNH4 0.025NO2 | 0.025 | 0.113 |
| 7 | 905 | C Standard 0 ppb | 0.000 | -0.002 |
| 8 | 901 | H1 High | 0.250 | 0.990 |
| 9 | 904 | L1 Low | 0.025 | 0.115 |
| 10 | 904 | L1 Low | 0.025 | 0.116 |
| 11 | 1 | S Well 11 11-8 | 0.054 | -0.011 |
| 12 | 2 | S 12 11-8 | 0.005 | 0.072 |
| 13 | 3 | S 13 11-8 | 0.045 | 0.031 |
| 14 | 4 | S 14 11-8 | 0.001 | 0.004 |
| 15 | 5 | S 11 11-29 | 0.051 | -0.011 |
| 16 | 6 | S 12 11-29 | 0.004 | 0.070 |
| 17 | 7 | S 13 11-29 | 0.045 | 0.031 |
| 18 | 8 | S 14 11-29 | 0.002 | -0.002 |
| 19 | 9 | S 11 12-1 | 0.047 | -0.017 |
| 20 | 10 | S 12 12-1 | 0.004 | 0.076 |
| 21 | 11 | S 13 12-1 | 0.045 | 0.022 |
| 22 | 12 | S 14 12-1 | 0.001 | -0.020 |
| 23 | 13 | S 11 1-26 | 0.047 | 0.004 |
| 24 | 14 | S 12 1-26 | 0.004 | 0.098 |
| 25 | 15 | S 13 1-26 | 0.042 | 0.046 |
| 26 | 16 | S 14 1-26 | 0.001 | 0.012 |
| 27 | 901 | D Drift | 0.249 | 0.983 |
| 28 | 0 | B Final Base | 0.000 | -0.033 |

```

CORRECTIONS
Channel      : 1      2
Baseline    : Yes   Yes
Drift       : Yes   Yes
Carryover   : Yes   Yes
%           : 0.2   0.6
    
```

```

* ... Sample offscale
+ ... Result higher than sample limit
- ... Result lower than sample limit
R ... Standard passed
    
```

SEAL Analytical AACB 6.07 KE

Post-run Report

F ... Standard failed
N ... Value not calculated or not used
R ... Resample after offscale
M ... Peak marker moved manually
D ... Diluted sample
H ... Dual calibration used

** <END OF REPORT> **

Spectrophotometer with Calibration Curves for Total Dissolved Phosphorous

TDP Standards SRP Fall 2017

| Standard | Concentration (µg/L) | Absorbance | Corrected Absorbance | F Factor |
|----------|----------------------|------------|----------------------|----------|
| Blank | 0 | -0.0001 | - | - |
| 1 | 1 | 0.0054 | 0.0055 | 181.8181 |
| 2 | 2.5 | 0.0139 | 0.0140 | 178.5714 |
| 3 | 5 | 0.0280 | 0.0281 | 177.9359 |
| 4 | 10 | 0.0570 | 0.0571 | 175.1313 |
| 5 | 20 | 0.1137 | 0.1138 | 175.7469 |
| 6 | 50 | 0.2829 | 0.2830 | 176.6784 |
| 7 | 100 | 0.5766 | 0.5767 | 173.4003 |

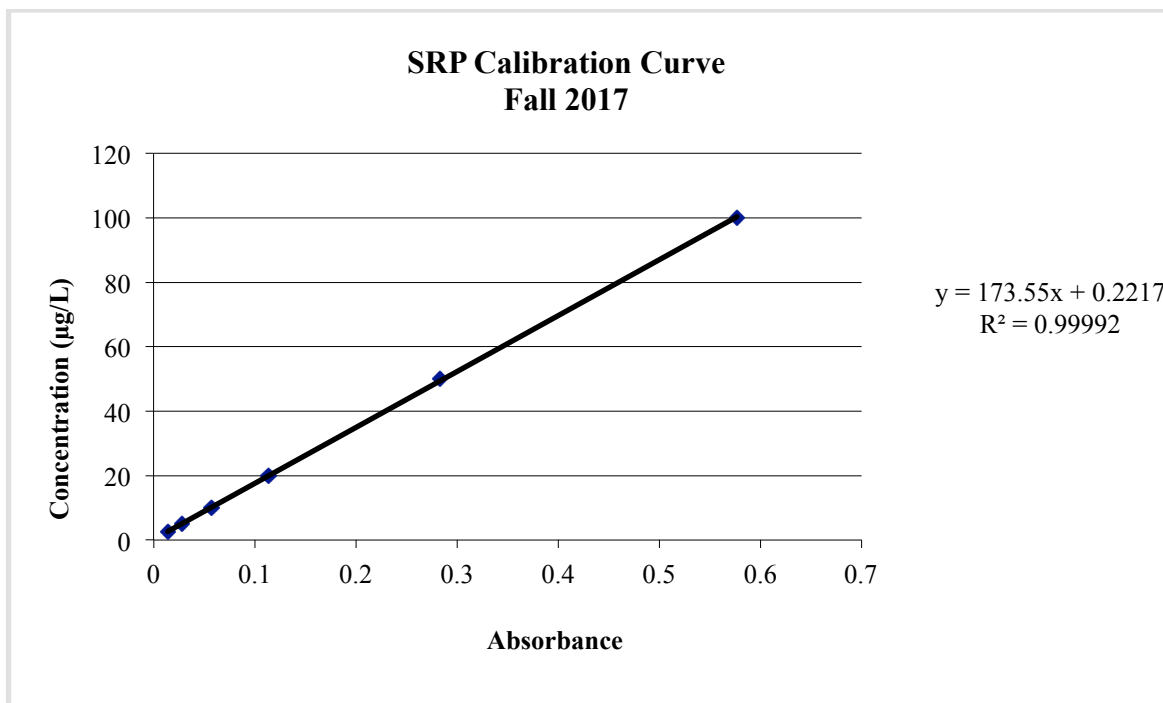

TDP IC Results Fall 2017

| Sample ID | Sample Date | Absorbance | Corrected Concentration (µg/L) |
|------------------|--------------------|-------------------|---------------------------------------|
| Well 11 | 6/29/17 | 0.0172 | 1.63 |
| Well 11 | 7/13/17 | 0.0366 | 4.71 |
| Well 11 | 7/18/17 | 0.0249 | 2.75 |
| Well 11 | 7/20/17 | 0.0264 | 3.16 |
| Well 11 | 7/25/17 | 0.0125 | 0.8386 |
| Well 11 | 7/27/17 | 0.0140 | 1.07 |
| Well 12 | 6/29/17 | 0.0271 | 3.38 |
| Well 12 | 7/13/17 | 0.0358 | 4.91 |
| Well 12 | 7/18/17 | 0.0502 | 6.99 |
| Well 12 | 7/20/17 | 0.0515 | 7.37 |
| Well 12 | 7/25/17 | 0.0228 | 2.56 |
| Well 12 | 7/27/17 | 0.0287 | 3.66 |
| Well 13 | 6/29/17 | 0.0124 | 0.7930 |
| Well 13 | 7/13/17 | 0.0368 | 4.74 |
| Well 13 | 7/18/17 | 0.0385 | 5.03 |
| Well 13 | 7/20/17 | 0.0232 | 2.63 |
| Well 13 | 7/25/17 | 0.0207 | 2.21 |
| Well 13 | 7/27/17 | 0.0251 | 2.95 |
| Fox River | 7/25/17 | 0.3586 | 58.88 |

TDP Standards SRP Winter 2017

| Standard | Concentration (µg/L) | Absorbance | Corrected Absorbance | F Factor |
|----------|----------------------|------------|----------------------|-------------|
| Blank | 0 | -0.0022 | - | - |
| 1 | 1 | 0.0032 | 0.0054 | 185.1851852 |
| 2 | 2.5 | 0.0101 | 0.0123 | 203.2520325 |
| 3 | 5 | 0.0242 | 0.0264 | 189.3939394 |
| 4 | 10 | 0.0499 | 0.0521 | 191.9385797 |
| 5 | 20 | 0.1038 | 0.106 | 188.6792453 |
| 6 | 50 | 0.2661 | 0.2683 | 186.3585539 |
| 7 | 100 | 0.5391 | 0.5413 | 184.7404397 |

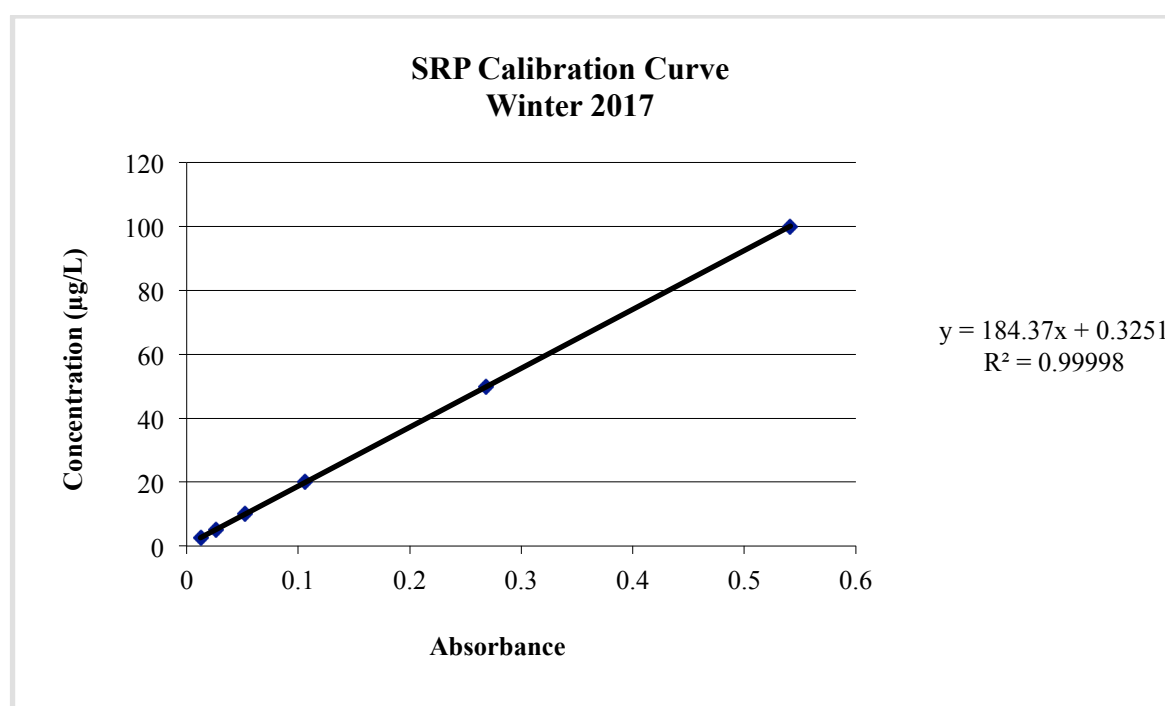

TDP IC Results Winter 2017

| Sample ID | Sample Date | Absorbance | Corrected Concentration (µg/L) |
|------------------|--------------------|-------------------|---------------------------------------|
| Well 11 | 11/8/17 | 0.0114 | 1.64 |
| Well 11 | 11/29/17 | 0.0162 | 2.55 |
| Well 11 | 12/1/17 | 0.0113 | 0.7296 |
| Well 11 | 1/26/18 | 0.0091 | 0.3474 |
| Well 12 | 11/8/17 | 0.0229 | 3.83 |
| Well 12 | 11/29/17 | 0.0116 | 1.67 |
| Well 12 | 12/1/17 | 0.0113 | 0.7296 |
| Well 12 | 1/26/18 | 0.0173 | 1.77 |
| Well 13 | 11/8/17 | 0.0122 | 1.79 |
| Well 13 | 11/29/17 | 0.0118 | 1.71 |
| Well 13 | 12/1/17 | 0.0122 | 1.79 |
| Well 13 | 1/26/18 | 0.0199 | 2.22 |

PHREEQC Files

Input file: C:\Users\madeline.salo\Desktop\WK11 12_22_18

Output file: C:\Users\madeline.salo\Desktop\WK11 12_22_18.pqo

Database file: C:\Program Files (x86)\USGS\Phreeqc Interactive 3.4.0-12927\database\phreeqc.dat

Reading data base.

SOLUTION_MASTER_SPECIES
SOLUTION_SPECIES
PHASES
EXCHANGE_MASTER_SPECIES
EXCHANGE_SPECIES
SURFACE_MASTER_SPECIES
SURFACE_SPECIES
RATES
END

Reading input data for simulation 1.

DATABASE C:\Program Files (x86)\USGS\Phreeqc Interactive 3.4.0-12927\database\phreeqc.dat
SOLUTION_MASTER_SPECIES
Acetate Acetate- 1.0 Acetate 59.
SOLUTION_SPECIES
Acetate- = Acetate-
log_k 0.0
analytical_expression -0.96597E+02 -0.34535E-01 0.19753E+04
0.38593E+02 0.30850E+02
Acetate- + H+ = AcetateH
log_k 4.76
delta_h 116.1 kcal/mol #from llnl.dat
END

End of simulation.

Reading input data for simulation 2.

SOLUTION 1 #WK11 collected on 2/28/17 through 1/26/18
Temp 10.42
pH 6.98
pe
redox pe

| | |
|------------|--------------|
| units | mg/L |
| density | 1 |
| Ca | 93.12 |
| Mg | 54.93 |
| Na | 101.43 |
| K | 3.3 |
| Fe(+2) | 0.1 |
| Alkalinity | 420.68 |
| Cl | 218.48 |
| S(6) | 64.11 |
| S(-2) | 0.1 |
| N(5) | 1.49 |
| N(3) | 0.05 |
| N(-3) | 0.001 |
| P | 0.002 |
| H(0) | 0.002 umol/L |
| O(0) | 0.182 |
| C(-4) | 0.007 umol/L |
| Acetate | 1.2 |
| water | 1 # kg |

END

Beginning of initial solution calculations.

Initial solution 1.

-----Solution composition-----

| Elements | Molality | Moles |
|------------|-----------|-----------|
| Acetate | 2.036e-05 | 2.036e-05 |
| Alkalinity | 8.414e-03 | 8.414e-03 |
| C(-4) | 7.007e-09 | 7.007e-09 |
| Ca | 2.326e-03 | 2.326e-03 |
| Cl | 6.168e-03 | 6.168e-03 |
| Fe(2) | 1.792e-06 | 1.792e-06 |
| H(0) | 2.002e-09 | 2.002e-09 |
| K | 8.448e-05 | 8.448e-05 |
| Mg | 2.262e-03 | 2.262e-03 |
| N(-3) | 7.146e-08 | 7.146e-08 |
| N(3) | 3.573e-06 | 3.573e-06 |
| N(5) | 1.065e-04 | 1.065e-04 |
| Na | 4.416e-03 | 4.416e-03 |
| O(0) | 1.139e-05 | 1.139e-05 |
| P | 6.463e-08 | 6.463e-08 |

| | | |
|-------|-----------|-----------|
| S(-2) | 3.122e-06 | 3.122e-06 |
| S(6) | 6.680e-04 | 6.680e-04 |

-----Description of solution-----

| | | |
|--|---|--------------|
| pH | = | 6.980 |
| pe | = | 6.980 |
| Specific Conductance ($\mu\text{S}/\text{cm}$, 10^∞C) | = | 1006 |
| Density (g/cm^3) | = | 1.00052 |
| Volume (L) | = | 1.00063 |
| Activity of water | = | 1.000 |
| Ionic strength (mol/kgw) | = | 1.912e-02 |
| Mass of water (kg) | = | 1.000e+00 |
| Total carbon (mol/kg) | = | 1.053e-02 |
| Total CO2 (mol/kg) | = | 1.053e-02 |
| Temperature ($^\infty\text{C}$) | = | 10.42 |
| Electrical balance (eq) | = | -2.350e-03 |
| Percent error, $100*(\text{Cat}- \text{An})/(\text{Cat}+ \text{An})$ | = | -8.19 |
| Iterations | = | 10 |
| Total H | = | 1.110208e+02 |
| Total O | = | 5.553868e+01 |

-----Redox couples-----

| Redox couple | pe | Eh (volts) |
|--------------|---------|------------|
| C(-4)/C(4) | -2.9904 | -0.1682 |
| H(0)/H(1) | -4.0230 | -0.2263 |
| N(-3)/N(3) | 6.9617 | 0.3917 |
| N(-3)/N(5) | 7.4380 | 0.4185 |
| N(3)/N(5) | 8.8668 | 0.4989 |
| O(-2)/O(0) | 14.4994 | 0.8158 |
| S(-2)/S(6) | -3.0590 | -0.1721 |

-----Distribution of species-----

| Species | Molality | Activity | Log Molality | Log Activity | Log Gamma | mole V cm^3/mol |
|----------|-----------|-----------|--------------|--------------|-----------|---------------------------------|
| H+ | 1.172e-07 | 1.047e-07 | -6.931 | -6.980 | -0.049 | 0.00 |
| OH- | 3.343e-08 | 2.915e-08 | -7.476 | -7.535 | -0.059 | -4.87 |
| H2O | 5.551e+01 | 9.996e-01 | 1.744 | -0.000 | 0.000 | 18.02 |
| Acetate | 2.036e-05 | | | | | |
| Acetate- | 2.036e-05 | 1.783e-05 | -4.691 | -4.749 | -0.058 | (0) |
| AcetateH | 4.505e-12 | 4.525e-12 | -11.346 | -11.344 | 0.002 | (0) |
| C(-4) | 7.007e-09 | | | | | |
| CH4 | 7.007e-09 | 7.038e-09 | -8.154 | -8.153 | 0.002 | 34.03 |

| | | | | | | |
|----------|-----------|-----------|---------|---------|--------|--------|
| C(4) | 1.053e-02 | | | | | |
| HCO3- | 8.140e-03 | 7.165e-03 | -2.089 | -2.145 | -0.055 | 23.34 |
| CO2 | 2.152e-03 | 2.161e-03 | -2.667 | -2.665 | 0.002 | 33.68 |
| MgHCO3+ | 1.161e-04 | 1.015e-04 | -3.935 | -3.993 | -0.058 | 5.00 |
| CaHCO3+ | 9.884e-05 | 8.724e-05 | -4.005 | -4.059 | -0.054 | 9.03 |
| NaHCO3 | 1.687e-05 | 1.695e-05 | -4.773 | -4.771 | 0.002 | 1.80 |
| CaCO3 | 3.980e-06 | 3.997e-06 | -5.400 | -5.398 | 0.002 | -14.65 |
| CO3-2 | 3.751e-06 | 2.252e-06 | -5.426 | -5.647 | -0.222 | -6.90 |
| MgCO3 | 2.159e-06 | 2.169e-06 | -5.666 | -5.664 | 0.002 | -17.07 |
| FeHCO3+ | 5.700e-07 | 4.991e-07 | -6.244 | -6.302 | -0.058 | (0) |
| NaCO3- | 8.523e-08 | 7.464e-08 | -7.069 | -7.127 | -0.058 | -2.79 |
| (CO2)2 | 5.056e-08 | 5.078e-08 | -7.296 | -7.294 | 0.002 | 67.37 |
| FeCO3 | 3.747e-08 | 3.763e-08 | -7.426 | -7.424 | 0.002 | (0) |
| Ca | 2.326e-03 | | | | | |
| Ca+2 | 2.158e-03 | 1.295e-03 | -2.666 | -2.888 | -0.222 | -18.15 |
| CaHCO3+ | 9.884e-05 | 8.724e-05 | -4.005 | -4.059 | -0.054 | 9.03 |
| CaSO4 | 6.488e-05 | 6.517e-05 | -4.188 | -4.186 | 0.002 | 6.81 |
| CaCO3 | 3.980e-06 | 3.997e-06 | -5.400 | -5.398 | 0.002 | -14.65 |
| CaHPO4 | 6.666e-09 | 6.695e-09 | -8.176 | -8.174 | 0.002 | (0) |
| CaOH+ | 2.343e-09 | 2.052e-09 | -8.630 | -8.688 | -0.058 | (0) |
| CaH2PO4+ | 6.467e-10 | 5.693e-10 | -9.189 | -9.245 | -0.055 | (0) |
| CaPO4- | 1.287e-10 | 1.133e-10 | -9.890 | -9.946 | -0.055 | (0) |
| CaHSO4+ | 4.266e-11 | 3.735e-11 | -10.370 | -10.428 | -0.058 | (0) |
| Cl | 6.168e-03 | | | | | |
| Cl- | 6.168e-03 | 5.386e-03 | -2.210 | -2.269 | -0.059 | 17.49 |
| FeCl+ | 5.915e-09 | 5.179e-09 | -8.228 | -8.286 | -0.058 | (0) |
| Fe(2) | 1.792e-06 | | | | | |
| Fe+2 | 1.148e-06 | 6.966e-07 | -5.940 | -6.157 | -0.217 | -23.00 |
| FeHCO3+ | 5.700e-07 | 4.991e-07 | -6.244 | -6.302 | -0.058 | (0) |
| FeCO3 | 3.747e-08 | 3.763e-08 | -7.426 | -7.424 | 0.002 | (0) |
| FeSO4 | 2.958e-08 | 2.971e-08 | -7.529 | -7.527 | 0.002 | 38.22 |
| FeCl+ | 5.915e-09 | 5.179e-09 | -8.228 | -8.286 | -0.058 | (0) |
| Fe(HS)2 | 8.561e-10 | 8.598e-10 | -9.067 | -9.066 | 0.002 | (0) |
| FeOH+ | 7.612e-10 | 6.688e-10 | -9.118 | -9.175 | -0.056 | (0) |
| FeHPO4 | 3.466e-11 | 3.482e-11 | -10.460 | -10.458 | 0.002 | (0) |
| FeH2PO4+ | 9.151e-12 | 8.055e-12 | -11.039 | -11.094 | -0.055 | (0) |
| Fe(HS)3- | 1.258e-13 | 1.102e-13 | -12.900 | -12.958 | -0.058 | (0) |
| FeHSO4+ | 2.294e-14 | 2.009e-14 | -13.639 | -13.697 | -0.058 | (0) |
| Fe(OH)2 | 1.426e-14 | 1.432e-14 | -13.846 | -13.844 | 0.002 | (0) |
| Fe(OH)3- | 4.974e-18 | 4.370e-18 | -17.303 | -17.360 | -0.056 | (0) |
| H(0) | 2.002e-09 | | | | | |
| H2 | 1.001e-09 | 1.005e-09 | -9.000 | -8.998 | 0.002 | 28.62 |
| K | 8.448e-05 | | | | | |
| K+ | 8.433e-05 | 7.358e-05 | -4.074 | -4.133 | -0.059 | 8.50 |
| KSO4- | 1.427e-07 | 1.256e-07 | -6.846 | -6.901 | -0.055 | 33.64 |
| KHPO4- | 2.046e-12 | 1.801e-12 | -11.689 | -11.744 | -0.055 | 39.47 |

| | | | | | | |
|----------|-----------|-----------|---------|---------|--------|--------|
| Mg | 2.262e-03 | | | | | |
| Mg+2 | 2.080e-03 | 1.262e-03 | -2.682 | -2.899 | -0.217 | -20.98 |
| MgHCO3+ | 1.161e-04 | 1.015e-04 | -3.935 | -3.993 | -0.058 | 5.00 |
| MgSO4 | 6.301e-05 | 6.328e-05 | -4.201 | -4.199 | 0.002 | 5.14 |
| MgCO3 | 2.159e-06 | 2.169e-06 | -5.666 | -5.664 | 0.002 | -17.07 |
| MgOH+ | 1.239e-08 | 1.096e-08 | -7.907 | -7.960 | -0.053 | (0) |
| MgHPO4 | 8.784e-09 | 8.822e-09 | -8.056 | -8.054 | 0.002 | (0) |
| MgH2PO4+ | 8.027e-10 | 7.065e-10 | -9.095 | -9.151 | -0.055 | (0) |
| MgPO4- | 1.692e-10 | 1.490e-10 | -9.772 | -9.827 | -0.055 | (0) |
| N(-3) | 7.146e-08 | | | | | |
| NH4+ | 7.106e-08 | 6.162e-08 | -7.148 | -7.210 | -0.062 | 17.40 |
| NH4SO4- | 2.878e-10 | 2.520e-10 | -9.541 | -9.599 | -0.058 | 32.27 |
| NH3 | 1.128e-10 | 1.133e-10 | -9.948 | -9.946 | 0.002 | 23.54 |
| N(3) | 3.573e-06 | | | | | |
| NO2- | 3.573e-06 | 3.107e-06 | -5.447 | -5.508 | -0.061 | 24.02 |
| N(5) | 1.065e-04 | | | | | |
| NO3- | 1.065e-04 | 9.260e-05 | -3.973 | -4.033 | -0.061 | 27.81 |
| Na | 4.416e-03 | | | | | |
| Na+ | 4.393e-03 | 3.856e-03 | -2.357 | -2.414 | -0.057 | -2.29 |
| NaHCO3 | 1.687e-05 | 1.695e-05 | -4.773 | -4.771 | 0.002 | 1.80 |
| NaSO4- | 6.323e-06 | 5.566e-06 | -5.199 | -5.254 | -0.055 | 14.83 |
| NaCO3- | 8.523e-08 | 7.464e-08 | -7.069 | -7.127 | -0.058 | -2.79 |
| NaHPO4- | 1.072e-10 | 9.439e-11 | -9.970 | -10.025 | -0.055 | 34.98 |
| NaOH | 1.119e-20 | 1.124e-20 | -19.951 | -19.949 | 0.002 | (0) |
| O(0) | 1.139e-05 | | | | | |
| O2 | 5.693e-06 | 5.718e-06 | -5.245 | -5.243 | 0.002 | 29.00 |
| P | 6.463e-08 | | | | | |
| H2PO4- | 2.621e-08 | 2.307e-08 | -7.581 | -7.637 | -0.055 | 33.62 |
| HPO4-2 | 2.107e-08 | 1.255e-08 | -7.676 | -7.901 | -0.225 | 7.36 |
| MgHPO4 | 8.784e-09 | 8.822e-09 | -8.056 | -8.054 | 0.002 | (0) |
| CaHPO4 | 6.666e-09 | 6.695e-09 | -8.176 | -8.174 | 0.002 | (0) |
| MgH2PO4+ | 8.027e-10 | 7.065e-10 | -9.095 | -9.151 | -0.055 | (0) |
| CaH2PO4+ | 6.467e-10 | 5.693e-10 | -9.189 | -9.245 | -0.055 | (0) |
| MgPO4- | 1.692e-10 | 1.490e-10 | -9.772 | -9.827 | -0.055 | (0) |
| CaPO4- | 1.287e-10 | 1.133e-10 | -9.890 | -9.946 | -0.055 | (0) |
| NaHPO4- | 1.072e-10 | 9.439e-11 | -9.970 | -10.025 | -0.055 | 34.98 |
| FeHPO4 | 3.466e-11 | 3.482e-11 | -10.460 | -10.458 | 0.002 | (0) |
| FeH2PO4+ | 9.151e-12 | 8.055e-12 | -11.039 | -11.094 | -0.055 | (0) |
| KHPO4- | 2.046e-12 | 1.801e-12 | -11.689 | -11.744 | -0.055 | 39.47 |
| H3PO4 | 2.950e-13 | 2.963e-13 | -12.530 | -12.528 | 0.002 | 46.41 |
| PO4-3 | 1.334e-13 | 3.979e-14 | -12.875 | -13.400 | -0.525 | -21.32 |
| S(-2) | 3.122e-06 | | | | | |
| H2S | 1.770e-06 | 1.778e-06 | -5.752 | -5.750 | 0.002 | 37.09 |
| HS- | 1.350e-06 | 1.177e-06 | -5.870 | -5.929 | -0.059 | 19.73 |
| Fe(HS)2 | 8.561e-10 | 8.598e-10 | -9.067 | -9.066 | 0.002 | (0) |
| S-2 | 7.972e-13 | 4.750e-13 | -12.098 | -12.323 | -0.225 | (0) |

| | | | | | | |
|----------|-----------|-----------|---------|---------|--------|-------|
| Fe(HS)3- | 1.258e-13 | 1.102e-13 | -12.900 | -12.958 | -0.058 | (0) |
| S(6) | 6.680e-04 | | | | | |
| SO4-2 | 5.336e-04 | 3.174e-04 | -3.273 | -3.498 | -0.226 | 12.20 |
| CaSO4 | 6.488e-05 | 6.517e-05 | -4.188 | -4.186 | 0.002 | 6.81 |
| MgSO4 | 6.301e-05 | 6.328e-05 | -4.201 | -4.199 | 0.002 | 5.14 |
| NaSO4- | 6.323e-06 | 5.566e-06 | -5.199 | -5.254 | -0.055 | 14.83 |
| KSO4- | 1.427e-07 | 1.256e-07 | -6.846 | -6.901 | -0.055 | 33.64 |
| FeSO4 | 2.958e-08 | 2.971e-08 | -7.529 | -7.527 | 0.002 | 38.22 |
| HSO4- | 2.740e-09 | 2.399e-09 | -8.562 | -8.620 | -0.058 | 39.03 |
| NH4SO4- | 2.878e-10 | 2.520e-10 | -9.541 | -9.599 | -0.058 | 32.27 |
| CaHSO4+ | 4.266e-11 | 3.735e-11 | -10.370 | -10.428 | -0.058 | (0) |
| FeHSO4+ | 2.294e-14 | 2.009e-14 | -13.639 | -13.697 | -0.058 | (0) |

-----Saturation indices-----

| Phase | SI** | log | IAP | log K(283 K, 1 atm) |
|----------------|--------|-----|--------|-----------------------|
| Anhydrite | -2.26 | | -6.39 | -4.13 CaSO4 |
| Aragonite | -0.28 | | -8.54 | -8.26 CaCO3 |
| Calcite | -0.12 | | -8.54 | -8.41 CaCO3 |
| CH4(g) | -5.52 | | -8.15 | -2.64 CH4 |
| CO2(g) | -1.39 | | -2.67 | -1.28 CO2 |
| Dolomite | -0.35 | | -17.08 | -16.73 CaMg(CO3)2 |
| FeS(ppt) | -1.19 | | -5.11 | -3.92 FeS |
| Gypsum | -1.79 | | -6.39 | -4.60 CaSO4:2H2O |
| H2(g) | -5.94 | | -9.00 | -3.06 H2 |
| H2O(g) | -1.90 | | -0.00 | 1.90 H2O |
| H2S(g) | -4.88 | | -12.91 | -8.03 H2S |
| Halite | -6.24 | | -4.68 | 1.56 NaCl |
| Hydroxyapatite | -8.16 | | -10.22 | -2.06 Ca5(PO4)3OH |
| Mackinawite | -0.46 | | -5.11 | -4.65 FeS |
| Melanterite | -7.25 | | -9.66 | -2.40 FeSO4:7H2O |
| NH3(g) | -12.06 | | -9.95 | 2.12 NH3 |
| O2(g) | -2.47 | | -5.24 | -2.77 O2 |
| Pyrite | 28.81 | | 9.90 | -18.90 FeS2 |
| Siderite | -1.01 | | -11.80 | -10.80 FeCO3 |
| Sulfur | 16.93 | | 22.17 | 5.24 S |
| Sylvite | -7.23 | | -6.40 | 0.82 KCl |
| Vivianite | -9.27 | | -45.27 | -36.00 Fe3(PO4)2:8H2O |

**For a gas, SI = log10(fugacity). Fugacity = pressure * phi / 1 atm.

For ideal gases, phi = 1.

End of simulation.

Reading input data for simulation 3.

End of Run after 0.049 Seconds.

Input file: C:\Users\madeline.salo\Desktop\WK12 12_22_18

Output file: C:\Users\madeline.salo\Desktop\WK12 12_22_18.pqo

Database file: C:\Program Files (x86)\USGS\Phreeqc Interactive 3.4.0-12927\database\wateq4f.dat

Reading data base.

SOLUTION_MASTER_SPECIES
SOLUTION_SPECIES
PHASES
EXCHANGE_MASTER_SPECIES
EXCHANGE_SPECIES
SURFACE_MASTER_SPECIES
SURFACE_SPECIES
RATES
END

Reading input data for simulation 1.

DATABASE C:\Program Files (x86)\USGS\Phreeqc Interactive 3.4.0-12927\database\wateq4f.dat
SOLUTION_MASTER_SPECIES
Acetate Acetate- 1.0 Acetate 59.
SOLUTION_SPECIES
Acetate- = Acetate-
log_k 0.0
analytical_expression -0.96597E+02 -0.34535E-01 0.19753E+04
0.38593E+02 0.30850E+02
Acetate- + H+ = AcetateH
log_k 4.76
delta_h 116.1 kcal/mol #from llnl.dat
END

End of simulation.

Reading input data for simulation 2.

SOLUTION 1 #WK11 collected on 2/28/17 through 12/1/17
Temp 10.61
pH 6.99

```

pe
redox      pe
units      mg/L
density    1
Ca         90.48
Mg         53.32
Na         81.1
K          3.16
Fe(+2)    0.1
Alkalinity 462.25
Cl         201.28
S(6)      68.17
S(-2)     0.1
N(5)      0.3
N(3)      0.003
N(-3)     0.07
P          0.004
H(0)      0.005 umol/L
O(0)      0.1475
C(-4)     0.417 umol/L
Acetate   2.27
water     1 # kg
END

```

Beginning of initial solution calculations.

Initial solution 1.

-----Solution composition-----

| Elements | Molality | Moles |
|------------|-----------|-----------|
| Acetate | 3.851e-05 | 3.851e-05 |
| Alkalinity | 9.245e-03 | 9.245e-03 |
| C(-4) | 4.174e-07 | 4.174e-07 |
| Ca | 2.260e-03 | 2.260e-03 |
| Cl | 5.683e-03 | 5.683e-03 |
| Fe(2) | 1.792e-06 | 1.792e-06 |
| H(0) | 5.005e-09 | 5.005e-09 |
| K | 8.089e-05 | 8.089e-05 |
| Mg | 2.195e-03 | 2.195e-03 |
| N(-3) | 5.002e-06 | 5.002e-06 |
| N(3) | 2.144e-07 | 2.144e-07 |
| N(5) | 2.144e-05 | 2.144e-05 |
| Na | 3.531e-03 | 3.531e-03 |

| | | |
|-------|-----------|-----------|
| O(0) | 9.228e-06 | 9.228e-06 |
| P | 1.293e-07 | 1.293e-07 |
| S(-2) | 3.122e-06 | 3.122e-06 |
| S(6) | 7.103e-04 | 7.103e-04 |

-----Description of solution-----

| | | |
|--|---|--------------|
| pH | = | 6.990 |
| pe | = | 6.990 |
| Activity of water | = | 1.000 |
| Ionic strength (mol/kgw) | = | 1.856e-02 |
| Mass of water (kg) | = | 1.000e+00 |
| Total carbon (mol/kg) | = | 1.150e-02 |
| Total CO2 (mol/kg) | = | 1.150e-02 |
| Temperature (°C) | = | 10.61 |
| Electrical balance (eq) | = | -3.840e-03 |
| Percent error, 100*(Cat- An)/(Cat+ An) | = | -13.80 |
| Iterations | = | 10 |
| Total H | = | 1.110216e+02 |
| Total O | = | 5.554132e+01 |

-----Redox couples-----

| Redox couple | pe | Eh (volts) |
|--------------|---------|------------|
| C(-4)/C(4) | -3.2220 | -0.1814 |
| H(0)/H(1) | -4.2324 | -0.2383 |
| N(-3)/N(3) | 6.4247 | 0.3617 |
| N(-3)/N(5) | 7.0953 | 0.3995 |
| N(3)/N(5) | 9.1069 | 0.5127 |
| O(-2)/O(0) | 14.4491 | 0.8135 |
| S(-2)/S(6) | -3.0667 | -0.1727 |

-----Distribution of species-----

| Species | Molality | Activity | Log Molality | Log Activity | Log Gamma | mole V cm ³ /mol |
|----------|-----------|-----------|--------------|--------------|-----------|-----------------------------|
| H+ | 1.144e-07 | 1.023e-07 | -6.942 | -6.990 | -0.048 | 0.00 |
| OH- | 3.453e-08 | 3.016e-08 | -7.462 | -7.521 | -0.059 | (0) |
| H2O | 5.551e+01 | 9.996e-01 | 1.744 | -0.000 | 0.000 | 18.02 |
| Acetate | 3.851e-05 | | | | | |
| Acetate- | 3.851e-05 | 3.378e-05 | -4.414 | -4.471 | -0.057 | (0) |
| AcetateH | 9.577e-12 | 9.618e-12 | -11.019 | -11.017 | 0.002 | (0) |
| C(-4) | 4.174e-07 | | | | | |
| CH4 | 4.174e-07 | 4.192e-07 | -6.379 | -6.378 | 0.002 | (0) |

| | | | | | | |
|----------|-----------|-----------|---------|---------|--------|-----|
| C(4) | 1.150e-02 | | | | | |
| HCO3- | 8.939e-03 | 7.880e-03 | -2.049 | -2.103 | -0.055 | (0) |
| CO2 | 2.303e-03 | 2.313e-03 | -2.638 | -2.636 | 0.002 | (0) |
| MgHCO3+ | 1.236e-04 | 1.082e-04 | -3.908 | -3.966 | -0.058 | (0) |
| CaHCO3+ | 1.056e-04 | 9.334e-05 | -3.976 | -4.030 | -0.054 | (0) |
| NaHCO3 | 1.361e-05 | 1.367e-05 | -4.866 | -4.864 | 0.002 | (0) |
| CaCO3 | 4.354e-06 | 4.373e-06 | -5.361 | -5.359 | 0.002 | (0) |
| CO3-2 | 4.220e-06 | 2.549e-06 | -5.375 | -5.594 | -0.219 | (0) |
| MgCO3 | 2.374e-06 | 2.384e-06 | -5.625 | -5.623 | 0.002 | (0) |
| FeHCO3+ | 6.069e-07 | 5.323e-07 | -6.217 | -6.274 | -0.057 | (0) |
| NaCO3- | 7.747e-08 | 6.830e-08 | -7.111 | -7.166 | -0.055 | (0) |
| FeCO3 | 4.112e-08 | 4.129e-08 | -7.386 | -7.384 | 0.002 | (0) |
| Ca | 2.260e-03 | | | | | |
| Ca+2 | 2.076e-03 | 1.254e-03 | -2.683 | -2.902 | -0.219 | (0) |
| CaHCO3+ | 1.056e-04 | 9.334e-05 | -3.976 | -4.030 | -0.054 | (0) |
| CaSO4 | 7.326e-05 | 7.357e-05 | -4.135 | -4.133 | 0.002 | (0) |
| CaCO3 | 4.354e-06 | 4.373e-06 | -5.361 | -5.359 | 0.002 | (0) |
| CaHPO4 | 1.323e-08 | 1.328e-08 | -7.879 | -7.877 | 0.002 | (0) |
| CaOH+ | 2.299e-09 | 2.032e-09 | -8.638 | -8.692 | -0.054 | (0) |
| CaH2PO4+ | 1.251e-09 | 1.103e-09 | -8.903 | -8.958 | -0.055 | (0) |
| CaPO4- | 2.620e-10 | 2.310e-10 | -9.582 | -9.636 | -0.055 | (0) |
| CaHSO4+ | 4.315e-11 | 3.785e-11 | -10.365 | -10.422 | -0.057 | (0) |
| Cl | 5.683e-03 | | | | | |
| Cl- | 5.683e-03 | 4.967e-03 | -2.245 | -2.304 | -0.058 | (0) |
| FeCl+ | 5.263e-09 | 4.631e-09 | -8.279 | -8.334 | -0.056 | (0) |
| Fe(2) | 1.792e-06 | | | | | |
| Fe+2 | 1.107e-06 | 6.755e-07 | -5.956 | -6.170 | -0.214 | (0) |
| FeHCO3+ | 6.069e-07 | 5.323e-07 | -6.217 | -6.274 | -0.057 | (0) |
| FeCO3 | 4.112e-08 | 4.129e-08 | -7.386 | -7.384 | 0.002 | (0) |
| FeSO4 | 3.073e-08 | 3.086e-08 | -7.512 | -7.511 | 0.002 | (0) |
| FeCl+ | 5.263e-09 | 4.631e-09 | -8.279 | -8.334 | -0.056 | (0) |
| Fe(HS)2 | 8.449e-10 | 8.486e-10 | -9.073 | -9.071 | 0.002 | (0) |
| FeOH+ | 7.661e-10 | 6.741e-10 | -9.116 | -9.171 | -0.056 | (0) |
| FeHPO4 | 6.864e-11 | 6.893e-11 | -10.163 | -10.162 | 0.002 | (0) |
| FeH2PO4+ | 1.766e-11 | 1.557e-11 | -10.753 | -10.808 | -0.055 | (0) |
| Fe(HS)3- | 1.251e-13 | 1.097e-13 | -12.903 | -12.960 | -0.057 | (0) |
| FeHSO4+ | 2.325e-14 | 2.039e-14 | -13.634 | -13.691 | -0.057 | (0) |
| Fe(OH)2 | 1.498e-14 | 1.505e-14 | -13.824 | -13.823 | 0.002 | (0) |
| Fe(OH)3- | 5.349e-18 | 4.707e-18 | -17.272 | -17.327 | -0.056 | (0) |
| H(0) | 5.005e-09 | | | | | |
| H2 | 2.502e-09 | 2.513e-09 | -8.602 | -8.600 | 0.002 | (0) |
| K | 8.089e-05 | | | | | |
| K+ | 8.075e-05 | 7.057e-05 | -4.093 | -4.151 | -0.058 | (0) |
| KSO4- | 1.464e-07 | 1.290e-07 | -6.835 | -6.889 | -0.055 | (0) |
| KHPO4- | 4.001e-12 | 3.527e-12 | -11.398 | -11.453 | -0.055 | (0) |
| Mg | 2.195e-03 | | | | | |

| | | | | | | |
|----------|-----------|-----------|---------|---------|--------|-----|
| Mg+2 | 2.004e-03 | 1.223e-03 | -2.698 | -2.913 | -0.215 | (0) |
| MgHCO3+ | 1.236e-04 | 1.082e-04 | -3.908 | -3.966 | -0.058 | (0) |
| MgSO4 | 6.550e-05 | 6.578e-05 | -4.184 | -4.182 | 0.002 | (0) |
| MgCO3 | 2.374e-06 | 2.384e-06 | -5.625 | -5.623 | 0.002 | (0) |
| MgHPO4 | 1.744e-08 | 1.752e-08 | -7.758 | -7.757 | 0.002 | (0) |
| MgOH+ | 1.250e-08 | 1.107e-08 | -7.903 | -7.956 | -0.053 | (0) |
| MgH2PO4+ | 1.554e-09 | 1.370e-09 | -8.809 | -8.863 | -0.055 | (0) |
| MgPO4- | 3.447e-10 | 3.039e-10 | -9.463 | -9.517 | -0.055 | (0) |
| N(-3) | 5.002e-06 | | | | | |
| NH4+ | 4.972e-06 | 4.361e-06 | -5.303 | -5.360 | -0.057 | (0) |
| NH4SO4- | 2.163e-08 | 1.903e-08 | -7.665 | -7.721 | -0.056 | (0) |
| NH3 | 8.331e-09 | 8.331e-09 | -8.079 | -8.079 | 0.000 | (0) |
| N(3) | 2.144e-07 | | | | | |
| NO2- | 2.144e-07 | 1.880e-07 | -6.669 | -6.726 | -0.057 | (0) |
| N(5) | 2.144e-05 | | | | | |
| NO3- | 2.144e-05 | 1.868e-05 | -4.669 | -4.729 | -0.060 | (0) |
| Na | 3.531e-03 | | | | | |
| Na+ | 3.512e-03 | 3.085e-03 | -2.454 | -2.511 | -0.056 | (0) |
| NaHCO3 | 1.361e-05 | 1.367e-05 | -4.866 | -4.864 | 0.002 | (0) |
| NaSO4- | 5.399e-06 | 4.759e-06 | -5.268 | -5.322 | -0.055 | (0) |
| NaCO3- | 7.747e-08 | 6.830e-08 | -7.111 | -7.166 | -0.055 | (0) |
| NaHPO4- | 1.749e-10 | 1.542e-10 | -9.757 | -9.812 | -0.055 | (0) |
| O(0) | 9.228e-06 | | | | | |
| O2 | 4.614e-06 | 4.634e-06 | -5.336 | -5.334 | 0.002 | (0) |
| P | 1.293e-07 | | | | | |
| H2PO4- | 5.216e-08 | 4.598e-08 | -7.283 | -7.337 | -0.055 | (0) |
| HPO4-2 | 4.276e-08 | 2.563e-08 | -7.369 | -7.591 | -0.222 | (0) |
| MgHPO4 | 1.744e-08 | 1.752e-08 | -7.758 | -7.757 | 0.002 | (0) |
| CaHPO4 | 1.323e-08 | 1.328e-08 | -7.879 | -7.877 | 0.002 | (0) |
| MgH2PO4+ | 1.554e-09 | 1.370e-09 | -8.809 | -8.863 | -0.055 | (0) |
| CaH2PO4+ | 1.251e-09 | 1.103e-09 | -8.903 | -8.958 | -0.055 | (0) |
| MgPO4- | 3.447e-10 | 3.039e-10 | -9.463 | -9.517 | -0.055 | (0) |
| CaPO4- | 2.620e-10 | 2.310e-10 | -9.582 | -9.636 | -0.055 | (0) |
| NaHPO4- | 1.749e-10 | 1.542e-10 | -9.757 | -9.812 | -0.055 | (0) |
| FeHPO4 | 6.864e-11 | 6.893e-11 | -10.163 | -10.162 | 0.002 | (0) |
| FeH2PO4+ | 1.766e-11 | 1.557e-11 | -10.753 | -10.808 | -0.055 | (0) |
| KHPO4- | 4.001e-12 | 3.527e-12 | -11.398 | -11.453 | -0.055 | (0) |
| PO4-3 | 2.639e-13 | 8.348e-14 | -12.578 | -13.078 | -0.500 | (0) |
| S(-2) | 3.122e-06 | | | | | |
| H2S | 1.733e-06 | 1.740e-06 | -5.761 | -5.759 | 0.002 | (0) |
| HS- | 1.359e-06 | 1.187e-06 | -5.867 | -5.925 | -0.059 | (0) |
| S6-2 | 2.244e-09 | 1.526e-09 | -8.649 | -8.816 | -0.167 | (0) |
| S5-2 | 2.000e-09 | 1.330e-09 | -8.699 | -8.876 | -0.177 | (0) |
| S4-2 | 1.156e-09 | 7.499e-10 | -8.937 | -9.125 | -0.188 | (0) |
| Fe(HS)2 | 8.449e-10 | 8.486e-10 | -9.073 | -9.071 | 0.002 | (0) |
| S-2 | 8.298e-13 | 4.975e-13 | -12.081 | -12.303 | -0.222 | (0) |

| | | | | | | |
|----------|-----------|-----------|---------|---------|--------|-----|
| S3-2 | 3.947e-13 | 2.489e-13 | -12.404 | -12.604 | -0.200 | (0) |
| Fe(HS)3- | 1.251e-13 | 1.097e-13 | -12.903 | -12.960 | -0.057 | (0) |
| S2-2 | 2.106e-14 | 1.297e-14 | -13.677 | -13.887 | -0.211 | (0) |
| S(6) | 7.103e-04 | | | | | |
| SO4-2 | 5.660e-04 | 3.387e-04 | -3.247 | -3.470 | -0.223 | (0) |
| CaSO4 | 7.326e-05 | 7.357e-05 | -4.135 | -4.133 | 0.002 | (0) |
| MgSO4 | 6.550e-05 | 6.578e-05 | -4.184 | -4.182 | 0.002 | (0) |
| NaSO4- | 5.399e-06 | 4.759e-06 | -5.268 | -5.322 | -0.055 | (0) |
| KSO4- | 1.464e-07 | 1.290e-07 | -6.835 | -6.889 | -0.055 | (0) |
| FeSO4 | 3.073e-08 | 3.086e-08 | -7.512 | -7.511 | 0.002 | (0) |
| NH4SO4- | 2.163e-08 | 1.903e-08 | -7.665 | -7.721 | -0.056 | (0) |
| HSO4- | 2.860e-09 | 2.511e-09 | -8.544 | -8.600 | -0.057 | (0) |
| CaHSO4+ | 4.315e-11 | 3.785e-11 | -10.365 | -10.422 | -0.057 | (0) |
| FeHSO4+ | 2.325e-14 | 2.039e-14 | -13.634 | -13.691 | -0.057 | (0) |

-----Saturation indices-----

| Phase | SI** log | IAP | log K(283 K, 1 atm) |
|----------------|----------|--------|---------------------------|
| Anhydrite | -2.04 | -6.37 | -4.34 CaSO4 |
| Aragonite | -0.24 | -8.50 | -8.26 CaCO3 |
| Artinite | -8.11 | 2.56 | 10.67 MgCO3:Mg(OH)2:3H2O |
| Brucite | -6.78 | 11.07 | 17.85 Mg(OH)2 |
| Calcite | -0.08 | -8.50 | -8.41 CaCO3 |
| CH4(g) | -3.64 | -6.38 | -2.73 CH4 |
| CO2(g) | -1.36 | -2.64 | -1.28 CO2 |
| Dolomite | -0.26 | -17.00 | -16.74 CaMg(CO3)2 |
| Dolomite(d) | -0.87 | -17.00 | -16.13 CaMg(CO3)2 |
| Epsomite | -4.14 | -6.38 | -2.24 MgSO4:7H2O |
| FeS(ppt) | -1.19 | -5.11 | -3.92 FeS |
| Gypsum | -1.78 | -6.37 | -4.59 CaSO4:2H2O |
| H2(g) | -5.52 | -8.60 | -3.08 H2 |
| H2O(g) | -1.90 | -0.00 | 1.90 H2O |
| H2S(g) | -4.93 | -5.76 | -0.83 H2S |
| Halite | -6.36 | -4.81 | 1.55 NaCl |
| Huntite | -5.00 | -34.01 | -29.01 CaMg3(CO3)4 |
| Hydromagnesite | -16.14 | -22.96 | -6.82 Mg5(CO3)4(OH)2:4H2O |
| Hydroxyapatite | -7.25 | -9.32 | -2.08 Ca5(PO4)3OH |
| Mackinawite | -0.46 | -5.11 | -4.65 FeS |
| Magnesite | -0.71 | -8.51 | -7.80 MgCO3 |
| Melanterite | -7.24 | -9.64 | -2.40 FeSO4:7H2O |
| Mirabilite | -6.67 | -8.49 | -1.82 Na2SO4:10H2O |
| Nahcolite | -3.93 | -4.61 | -0.69 NaHCO3 |
| Natron | -8.72 | -10.62 | -1.90 Na2CO3:10H2O |
| Nesquehonite | -3.10 | -8.51 | -5.41 MgCO3:3H2O |
| NH3(g) | -10.15 | -8.08 | 2.07 NH3 |

| | | | | |
|----------------|--------|--------|--------|--------------------|
| O2(g) | -2.56 | -5.33 | -2.77 | O2 |
| Portlandite | -12.87 | 11.08 | 23.95 | Ca(OH)2 |
| Pyrite | 28.84 | 9.94 | -18.90 | FeS2 |
| Siderite | -0.97 | -11.76 | -10.80 | FeCO3 |
| Siderite(d)(3) | -1.31 | -11.76 | -10.45 | FeCO3 |
| Sulfur | 17.00 | 1.68 | -15.32 | S |
| Thenardite | -8.33 | -8.49 | -0.16 | Na2SO4 |
| Thermonatrite | -10.84 | -10.62 | 0.23 | Na2CO3:H2O |
| Trona | -15.10 | -15.23 | -0.13 | NaHCO3:Na2CO3:2H2O |
| Vivianite | -8.67 | -44.67 | -36.00 | Fe3(PO4)2:8H2O |

**For a gas, SI = log10(fugacity). Fugacity = pressure * phi / 1 atm.

For ideal gases, phi = 1.

End of simulation.

Reading input data for simulation 3.

End of Run after 0.225 Seconds.

Input file: C:\Users\madeline.salo\Desktop\WK13 12_22_18
Output file: C:\Users\madeline.salo\Desktop\WK13 12_22_18.pqo
Database file: C:\Program Files (x86)\USGS\Phreeqc Interactive 3.4.0-12927\database\wateq4f.dat

Reading data base.

SOLUTION_MASTER_SPECIES
SOLUTION_SPECIES
PHASES
EXCHANGE_MASTER_SPECIES
EXCHANGE_SPECIES
SURFACE_MASTER_SPECIES
SURFACE_SPECIES
RATES
END

Reading input data for simulation 1.

DATABASE C:\Program Files (x86)\USGS\Phreeqc Interactive 3.4.0-12927\database\wateq4f.dat
SOLUTION_MASTER_SPECIES
Acetate Acetate- 1.0 Acetate 59.
SOLUTION_SPECIES
Acetate- = Acetate-
log_k 0.0
analytical_expression -0.96597E+02 -0.34535E-01 0.19753E+04
0.38593E+02 0.30850E+02
Acetate- + H+ = AcetateH
log_k 4.76
delta_h 116.1 kcal/mol #from llnl.dat
END

End of simulation.

Reading input data for simulation 2.

SOLUTION 1 #WK11 collected on 6/29/17 through 1/26/18
Temp 10.5
pH 7.06
pe
redox pe

| | |
|------------|--------------|
| units | mg/L |
| density | 1 |
| Ca | 83.71 |
| Mg | 56.71 |
| Na | 39.79 |
| K | 2.56 |
| Fe(+2) | 0.1 |
| Alkalinity | 411.26 |
| Cl | 97.24 |
| S(6) | 96.9 |
| S(-2) | 0.1 |
| N(5) | 1.74 |
| N(3) | 0.04 |
| N(-3) | 0.03 |
| P | 0.003 |
| H(0) | 0.004 umol/L |
| O(0) | 0.14375 |
| C(-4) | 0.043 umol/L |
| Acetate | 1.59 |
| water | 1 # kg |

END

Beginning of initial solution calculations.

Initial solution 1.

-----Solution composition-----

| Elements | Molality | Moles |
|------------|-----------|-----------|
| Acetate | 2.697e-05 | 2.697e-05 |
| Alkalinity | 8.223e-03 | 8.223e-03 |
| C(-4) | 4.303e-08 | 4.303e-08 |
| Ca | 2.090e-03 | 2.090e-03 |
| Cl | 2.745e-03 | 2.745e-03 |
| Fe(2) | 1.792e-06 | 1.792e-06 |
| H(0) | 4.003e-09 | 4.003e-09 |
| K | 6.552e-05 | 6.552e-05 |
| Mg | 2.334e-03 | 2.334e-03 |
| N(-3) | 2.144e-06 | 2.144e-06 |
| N(3) | 2.858e-06 | 2.858e-06 |
| N(5) | 1.243e-04 | 1.243e-04 |
| Na | 1.732e-03 | 1.732e-03 |
| O(0) | 8.991e-06 | 8.991e-06 |
| P | 9.693e-08 | 9.693e-08 |

| | | |
|-------|-----------|-----------|
| S(-2) | 3.121e-06 | 3.121e-06 |
| S(6) | 1.010e-03 | 1.010e-03 |

-----Description of solution-----

| | | |
|--|---|--------------|
| pH | = | 7.060 |
| pe | = | 7.060 |
| Activity of water | = | 1.000 |
| Ionic strength (mol/kgw) | = | 1.606e-02 |
| Mass of water (kg) | = | 1.000e+00 |
| Total carbon (mol/kg) | = | 9.947e-03 |
| Total CO2 (mol/kg) | = | 9.947e-03 |
| Temperature (∞C) | = | 10.50 |
| Electrical balance (eq) | = | -2.462e-03 |
| Percent error, 100*(Cat- An)/(Cat+ An) | = | -10.95 |
| Iterations | = | 10 |
| Total H | = | 1.110206e+02 |
| Total O | = | 5.553872e+01 |

-----Redox couples-----

| Redox couple | pe | Eh (volts) |
|--------------|---------|------------|
| C(-4)/C(4) | -3.1812 | -0.1790 |
| H(0)/H(1) | -4.2535 | -0.2394 |
| N(-3)/N(3) | 6.5875 | 0.3707 |
| N(-3)/N(5) | 7.1564 | 0.4028 |
| N(3)/N(5) | 8.8629 | 0.4988 |
| O(-2)/O(0) | 14.3863 | 0.8096 |
| S(-2)/S(6) | -3.1274 | -0.1760 |

-----Distribution of species-----

| Species | Molality | Activity | Log Molality | Log Activity | Log Gamma | mole V cm ³ /mol |
|----------|-----------|-----------|--------------|--------------|-----------|-----------------------------|
| H+ | 9.683e-08 | 8.710e-08 | -7.014 | -7.060 | -0.046 | 0.00 |
| OH- | 3.985e-08 | 3.510e-08 | -7.400 | -7.455 | -0.055 | (0) |
| H2O | 5.551e+01 | 9.997e-01 | 1.744 | -0.000 | 0.000 | 18.02 |
| Acetate | 2.697e-05 | | | | | |
| Acetate- | 2.697e-05 | 2.384e-05 | -4.569 | -4.623 | -0.054 | (0) |
| AcetateH | 5.314e-12 | 5.334e-12 | -11.275 | -11.273 | 0.002 | (0) |
| C(-4) | 4.303e-08 | | | | | |
| CH4 | 4.303e-08 | 4.319e-08 | -7.366 | -7.365 | 0.002 | (0) |
| C(4) | 9.947e-03 | | | | | |
| HCO3- | 7.959e-03 | 7.067e-03 | -2.099 | -2.151 | -0.052 | (0) |

| | | | | | | |
|----------|-----------|-----------|---------|---------|--------|-----|
| CO2 | 1.763e-03 | 1.770e-03 | -2.754 | -2.752 | 0.002 | (0) |
| MgHCO3+ | 1.189e-04 | 1.050e-04 | -3.925 | -3.979 | -0.054 | (0) |
| CaHCO3+ | 8.816e-05 | 7.847e-05 | -4.055 | -4.105 | -0.051 | (0) |
| NaHCO3 | 6.036e-06 | 6.058e-06 | -5.219 | -5.218 | 0.002 | (0) |
| CO3-2 | 4.306e-06 | 2.677e-06 | -5.366 | -5.572 | -0.206 | (0) |
| CaCO3 | 4.299e-06 | 4.315e-06 | -5.367 | -5.365 | 0.002 | (0) |
| MgCO3 | 2.695e-06 | 2.705e-06 | -5.569 | -5.568 | 0.002 | (0) |
| FeHCO3+ | 5.663e-07 | 5.005e-07 | -6.247 | -6.301 | -0.054 | (0) |
| FeCO3 | 4.531e-08 | 4.548e-08 | -7.344 | -7.342 | 0.002 | (0) |
| NaCO3- | 3.967e-08 | 3.522e-08 | -7.402 | -7.453 | -0.052 | (0) |
| Ca | 2.090e-03 | | | | | |
| Ca+2 | 1.897e-03 | 1.179e-03 | -2.722 | -2.929 | -0.207 | (0) |
| CaSO4 | 1.005e-04 | 1.009e-04 | -3.998 | -3.996 | 0.002 | (0) |
| CaHCO3+ | 8.816e-05 | 7.847e-05 | -4.055 | -4.105 | -0.051 | (0) |
| CaCO3 | 4.299e-06 | 4.315e-06 | -5.367 | -5.365 | 0.002 | (0) |
| CaHPO4 | 1.002e-08 | 1.005e-08 | -7.999 | -7.998 | 0.002 | (0) |
| CaOH+ | 2.523e-09 | 2.246e-09 | -8.598 | -8.649 | -0.051 | (0) |
| CaH2PO4+ | 8.003e-10 | 7.106e-10 | -9.097 | -9.148 | -0.052 | (0) |
| CaPO4- | 2.307e-10 | 2.049e-10 | -9.637 | -9.689 | -0.052 | (0) |
| CaHSO4+ | 4.992e-11 | 4.412e-11 | -10.302 | -10.355 | -0.054 | (0) |
| Cl | 2.745e-03 | | | | | |
| Cl- | 2.745e-03 | 2.419e-03 | -2.561 | -2.616 | -0.055 | (0) |
| FeCl+ | 2.668e-09 | 2.365e-09 | -8.574 | -8.626 | -0.052 | (0) |
| Fe(2) | 1.792e-06 | | | | | |
| Fe+2 | 1.129e-06 | 7.083e-07 | -5.947 | -6.150 | -0.202 | (0) |
| FeHCO3+ | 5.663e-07 | 5.005e-07 | -6.247 | -6.301 | -0.054 | (0) |
| FeSO4 | 4.696e-08 | 4.713e-08 | -7.328 | -7.327 | 0.002 | (0) |
| FeCO3 | 4.531e-08 | 4.548e-08 | -7.344 | -7.342 | 0.002 | (0) |
| FeCl+ | 2.668e-09 | 2.365e-09 | -8.574 | -8.626 | -0.052 | (0) |
| Fe(HS)2 | 1.053e-09 | 1.057e-09 | -8.978 | -8.976 | 0.002 | (0) |
| FeOH+ | 9.285e-10 | 8.231e-10 | -9.032 | -9.085 | -0.052 | (0) |
| FeHPO4 | 5.808e-11 | 5.830e-11 | -10.236 | -10.234 | 0.002 | (0) |
| FeH2PO4+ | 1.263e-11 | 1.121e-11 | -10.899 | -10.950 | -0.052 | (0) |
| Fe(HS)3- | 1.684e-13 | 1.489e-13 | -12.774 | -12.827 | -0.054 | (0) |
| FeHSO4+ | 2.999e-14 | 2.651e-14 | -13.523 | -13.577 | -0.054 | (0) |
| Fe(OH)2 | 2.128e-14 | 2.136e-14 | -13.672 | -13.670 | 0.002 | (0) |
| Fe(OH)3- | 8.847e-18 | 7.842e-18 | -17.053 | -17.106 | -0.052 | (0) |
| H(0) | 4.003e-09 | | | | | |
| H2 | 2.002e-09 | 2.009e-09 | -8.699 | -8.697 | 0.002 | (0) |
| K | 6.552e-05 | | | | | |
| K+ | 6.535e-05 | 5.759e-05 | -4.185 | -4.240 | -0.055 | (0) |
| KSO4- | 1.727e-07 | 1.533e-07 | -6.763 | -6.814 | -0.052 | (0) |
| KHPO4- | 2.614e-12 | 2.321e-12 | -11.583 | -11.634 | -0.052 | (0) |
| Mg | 2.334e-03 | | | | | |
| Mg+2 | 2.110e-03 | 1.323e-03 | -2.676 | -2.878 | -0.203 | (0) |
| MgHCO3+ | 1.189e-04 | 1.050e-04 | -3.925 | -3.979 | -0.054 | (0) |

| | | | | | | |
|----------|-----------|-----------|---------|---------|--------|-----|
| MgSO4 | 1.032e-04 | 1.036e-04 | -3.986 | -3.985 | 0.002 | (0) |
| MgCO3 | 2.695e-06 | 2.705e-06 | -5.569 | -5.568 | 0.002 | (0) |
| MgOH+ | 1.562e-08 | 1.392e-08 | -7.806 | -7.856 | -0.050 | (0) |
| MgHPO4 | 1.520e-08 | 1.526e-08 | -7.818 | -7.817 | 0.002 | (0) |
| MgH2PO4+ | 1.144e-09 | 1.016e-09 | -8.942 | -8.993 | -0.052 | (0) |
| MgPO4- | 3.494e-10 | 3.102e-10 | -9.457 | -9.508 | -0.052 | (0) |
| N(-3) | 2.144e-06 | | | | | |
| NH4+ | 2.126e-06 | 1.879e-06 | -5.672 | -5.726 | -0.054 | (0) |
| NH4SO4- | 1.350e-08 | 1.197e-08 | -7.870 | -7.922 | -0.052 | (0) |
| NH3 | 4.181e-09 | 4.181e-09 | -8.379 | -8.379 | 0.000 | (0) |
| N(3) | 2.858e-06 | | | | | |
| NO2- | 2.858e-06 | 2.526e-06 | -5.544 | -5.598 | -0.054 | (0) |
| N(5) | 1.243e-04 | | | | | |
| NO3- | 1.243e-04 | 1.092e-04 | -3.905 | -3.962 | -0.056 | (0) |
| Na | 1.732e-03 | | | | | |
| Na+ | 1.722e-03 | 1.524e-03 | -2.764 | -2.817 | -0.053 | (0) |
| NaHCO3 | 6.036e-06 | 6.058e-06 | -5.219 | -5.218 | 0.002 | (0) |
| NaSO4- | 3.862e-06 | 3.430e-06 | -5.413 | -5.465 | -0.052 | (0) |
| NaCO3- | 3.967e-08 | 3.522e-08 | -7.402 | -7.453 | -0.052 | (0) |
| NaHPO4- | 6.921e-11 | 6.145e-11 | -10.160 | -10.211 | -0.052 | (0) |
| O(0) | 8.991e-06 | | | | | |
| O2 | 4.496e-06 | 4.512e-06 | -5.347 | -5.346 | 0.002 | (0) |
| P | 9.693e-08 | | | | | |
| H2PO4- | 3.558e-08 | 3.159e-08 | -7.449 | -7.500 | -0.052 | (0) |
| HPO4-2 | 3.348e-08 | 2.067e-08 | -7.475 | -7.685 | -0.209 | (0) |
| MgHPO4 | 1.520e-08 | 1.526e-08 | -7.818 | -7.817 | 0.002 | (0) |
| CaHPO4 | 1.002e-08 | 1.005e-08 | -7.999 | -7.998 | 0.002 | (0) |
| MgH2PO4+ | 1.144e-09 | 1.016e-09 | -8.942 | -8.993 | -0.052 | (0) |
| CaH2PO4+ | 8.003e-10 | 7.106e-10 | -9.097 | -9.148 | -0.052 | (0) |
| MgPO4- | 3.494e-10 | 3.102e-10 | -9.457 | -9.508 | -0.052 | (0) |
| CaPO4- | 2.307e-10 | 2.049e-10 | -9.637 | -9.689 | -0.052 | (0) |
| NaHPO4- | 6.921e-11 | 6.145e-11 | -10.160 | -10.211 | -0.052 | (0) |
| FeHPO4 | 5.808e-11 | 5.830e-11 | -10.236 | -10.234 | 0.002 | (0) |
| FeH2PO4+ | 1.263e-11 | 1.121e-11 | -10.899 | -10.950 | -0.052 | (0) |
| KHPO4- | 2.614e-12 | 2.321e-12 | -11.583 | -11.634 | -0.052 | (0) |
| PO4-3 | 2.334e-13 | 7.892e-14 | -12.632 | -13.103 | -0.471 | (0) |
| S(-2) | 3.121e-06 | | | | | |
| H2S | 1.615e-06 | 1.621e-06 | -5.792 | -5.790 | 0.002 | (0) |
| HS- | 1.469e-06 | 1.294e-06 | -5.833 | -5.888 | -0.055 | (0) |
| S6-2 | 2.824e-09 | 1.954e-09 | -8.549 | -8.709 | -0.160 | (0) |
| S5-2 | 2.496e-09 | 1.692e-09 | -8.603 | -8.772 | -0.169 | (0) |
| S4-2 | 1.439e-09 | 9.537e-10 | -8.842 | -9.021 | -0.179 | (0) |
| Fe(HS)2 | 1.053e-09 | 1.057e-09 | -8.978 | -8.976 | 0.002 | (0) |
| S-2 | 1.023e-12 | 6.316e-13 | -11.990 | -12.200 | -0.209 | (0) |
| S3-2 | 4.897e-13 | 3.164e-13 | -12.310 | -12.500 | -0.190 | (0) |
| Fe(HS)3- | 1.684e-13 | 1.489e-13 | -12.774 | -12.827 | -0.054 | (0) |

| | | | | | | |
|---------|-----------|-----------|---------|---------|--------|-----|
| S2-2 | 2.605e-14 | 1.647e-14 | -13.584 | -13.783 | -0.199 | (0) |
| S(6) | 1.010e-03 | | | | | |
| SO4-2 | 8.017e-04 | 4.944e-04 | -3.096 | -3.306 | -0.210 | (0) |
| MgSO4 | 1.032e-04 | 1.036e-04 | -3.986 | -3.985 | 0.002 | (0) |
| CaSO4 | 1.005e-04 | 1.009e-04 | -3.998 | -3.996 | 0.002 | (0) |
| NaSO4- | 3.862e-06 | 3.430e-06 | -5.413 | -5.465 | -0.052 | (0) |
| KSO4- | 1.727e-07 | 1.533e-07 | -6.763 | -6.814 | -0.052 | (0) |
| FeSO4 | 4.696e-08 | 4.713e-08 | -7.328 | -7.327 | 0.002 | (0) |
| NH4SO4- | 1.350e-08 | 1.197e-08 | -7.870 | -7.922 | -0.052 | (0) |
| HSO4- | 3.519e-09 | 3.113e-09 | -8.454 | -8.507 | -0.053 | (0) |
| CaHSO4+ | 4.992e-11 | 4.412e-11 | -10.302 | -10.355 | -0.054 | (0) |
| FeHSO4+ | 2.999e-14 | 2.651e-14 | -13.523 | -13.577 | -0.054 | (0) |

-----Saturation indices-----

| Phase | SI** log | IAP | log K(283 K, 1 atm) |
|----------------|----------|--------|---------------------------|
| Anhydrite | -1.90 | -6.23 | -4.34 CaSO4 |
| Aragonite | -0.24 | -8.50 | -8.26 CaCO3 |
| Artinite | -7.89 | 2.79 | 10.68 MgCO3:Mg(OH)2:3H2O |
| Brucite | -6.61 | 11.24 | 17.86 Mg(OH)2 |
| Calcite | -0.09 | -8.50 | -8.41 CaCO3 |
| CH4(g) | -4.63 | -7.36 | -2.73 CH4 |
| CO2(g) | -1.48 | -2.75 | -1.28 CO2 |
| Dolomite | -0.22 | -16.95 | -16.74 CaMg(CO3)2 |
| Dolomite(d) | -0.83 | -16.95 | -16.12 CaMg(CO3)2 |
| Epsomite | -3.94 | -6.19 | -2.25 MgSO4:7H2O |
| FeS(ppt) | -1.06 | -4.98 | -3.92 FeS |
| Gypsum | -1.64 | -6.23 | -4.59 CaSO4:2H2O |
| H2(g) | -5.61 | -8.70 | -3.08 H2 |
| H2O(g) | -1.90 | -0.00 | 1.90 H2O |
| H2S(g) | -4.96 | -5.79 | -0.83 H2S |
| Halite | -6.98 | -5.43 | 1.55 NaCl |
| Huntite | -4.85 | -33.85 | -29.00 CaMg3(CO3)4 |
| Hydromagnesite | -15.76 | -22.56 | -6.80 Mg5(CO3)4(OH)2:4H2O |
| Hydroxyapatite | -7.39 | -9.46 | -2.07 Ca5(PO4)3OH |
| Mackinawite | -0.33 | -4.98 | -4.65 FeS |
| Magnesite | -0.65 | -8.45 | -7.80 MgCO3 |
| Melanterite | -7.05 | -9.46 | -2.40 FeSO4:7H2O |
| Mirabilite | -7.12 | -8.94 | -1.83 Na2SO4:10H2O |
| Nahcolite | -4.28 | -4.97 | -0.69 NaHCO3 |
| Natron | -9.31 | -11.21 | -1.90 Na2CO3:10H2O |
| Nesquehonite | -3.05 | -8.45 | -5.40 MgCO3:3H2O |
| NH3(g) | -10.45 | -8.38 | 2.08 NH3 |
| O2(g) | -2.57 | -5.35 | -2.77 O2 |
| Portlandite | -12.77 | 11.19 | 23.96 Ca(OH)2 |

| | | | |
|----------------|--------|--------|--------------------------|
| Pyrite | 29.22 | 10.31 | -18.90 FeS2 |
| Siderite | -0.93 | -11.72 | -10.80 FeCO3 |
| Siderite(d)(3) | -1.27 | -11.72 | -10.45 FeCO3 |
| Sulfur | 17.24 | 1.92 | -15.32 S |
| Thenardite | -8.78 | -8.94 | -0.16 Na2SO4 |
| Thermonatrite | -11.44 | -11.21 | 0.23 Na2CO3:H2O |
| Trona | -16.05 | -16.17 | -0.12 NaHCO3:Na2CO3:2H2O |
| Vivianite | -8.66 | -44.66 | -36.00 Fe3(PO4)2:8H2O |

**For a gas, SI = log10(fugacity). Fugacity = pressure * phi / 1 atm.

For ideal gases, phi = 1.

 End of simulation.

 Reading input data for simulation 3.

 End of Run after 0.23 Seconds.
